

includes complete amplifier
projects you can build

HIGH-POWER AUDIO AMPLIFIER CONSTRUCTION MANUAL

G . R a n d y S l o n e

HIGH-POWER AUDIO AMPLIFIER CONSTRUCTION MANUAL

This page intentionally left blank.

HIGH-POWER AUDIO AMPLIFIER CONSTRUCTION MANUAL

**50 TO 500 Watts for
the Audio Perfectionist**

G. Randy Slone

McGraw-Hill

New York San Francisco Washington, D.C. Auckland Bogotá
Caracas Lisbon London Madrid Mexico City Milan
Montreal New Delhi San Juan Singapore
Sydney Tokyo Toronto

McGraw-Hill

A Division of The McGraw-Hill Companies



Copyright © 1999 by The McGraw-Hill Companies. All rights reserved. Manufactured in the United States of America. Except as permitted under the United States Copyright Act of 1976, no part of this publication may be reproduced or distributed in any form or by any means, or stored in a database or retrieval system, without the prior written permission of the publisher.

0-07-139572-5

The material in this eBook also appears in the print version of this title: 0-07-134119-6.

All trademarks are trademarks of their respective owners. Rather than put a trademark symbol after every occurrence of a trademarked name, we use names in an editorial fashion only, and to the benefit of the trademark owner, with no intention of infringement of the trademark. Where such designations appear in this book, they have been printed with initial caps.

McGraw-Hill eBooks are available at special quantity discounts to use as premiums and sales promotions, or for use in corporate training programs. For more information, please contact George Hoare, Special Sales, at george_hoare@mcgraw-hill.com or (212) 904-4069.

TERMS OF USE

This is a copyrighted work and The McGraw-Hill Companies, Inc. (“McGraw-Hill”) and its licensors reserve all rights in and to the work. Use of this work is subject to these terms. Except as permitted under the Copyright Act of 1976 and the right to store and retrieve one copy of the work, you may not decompile, disassemble, reverse engineer, reproduce, modify, create derivative works based upon, transmit, distribute, disseminate, sell, publish or sublicense the work or any part of it without McGraw-Hill’s prior consent. You may use the work for your own noncommercial and personal use; any other use of the work is strictly prohibited. Your right to use the work may be terminated if you fail to comply with these terms.

THE WORK IS PROVIDED “AS IS”. McGRAW-HILL AND ITS LICENSORS MAKE NO GUARANTEES OR WARRANTIES AS TO THE ACCURACY, ADEQUACY OR COMPLETENESS OF OR RESULTS TO BE OBTAINED FROM USING THE WORK, INCLUDING ANY INFORMATION THAT CAN BE ACCESSED THROUGH THE WORK VIA HYPERLINK OR OTHERWISE, AND EXPRESSLY DISCLAIM ANY WARRANTY, EXPRESS OR IMPLIED, INCLUDING BUT NOT LIMITED TO IMPLIED WARRANTIES OF MERCHANTABILITY OR FITNESS FOR A PARTICULAR PURPOSE. McGraw-Hill and its licensors do not warrant or guarantee that the functions contained in the work will meet your requirements or that its operation will be uninterrupted or error free. Neither McGraw-Hill nor its licensors shall be liable to you or anyone else for any inaccuracy, error or omission, regardless of cause, in the work or for any damages resulting therefrom. McGraw-Hill has no responsibility for the content of any information accessed through the work. Under no circumstances shall McGraw-Hill and/or its licensors be liable for any indirect, incidental, special, punitive, consequential or similar damages that result from the use of or inability to use the work, even if any of them has been advised of the possibility of such damages. This limitation of liability shall apply to any claim or cause whatsoever whether such claim or cause arises in contract, tort or otherwise.

DOI: 10.1036/0071395725

CONTENTS

	Preface	xiii
	Acknowledgments	xv
Chapter 1	Fundamentals of High-Power Audio Amplifiers	1
	What Is Audio Amplification?	1
	The Social and Economic Importance of Audio Amplification	3
	Definition of High-Power Audio Amplifiers	4
	Definitions of High Quality	4
	The Major Applications	6
	Realistic Expectations for the Individual Builder	7
	Cost Considerations for the Hobbyist	9
	A Few Basics about Obtaining Parts and Materials	10
	Income Opportunities for the Professional	12
Chapter 2	Misinformation in Audio	15
	Science versus Subjectivism	15
	What Is the Subjectivist Position?	15
	Truths and Practicalities Involving Audio Power Amplifier Specifications	22
	Vacuum Tube versus Solid-State Designs	25
	Marketing Considerations—The Bottom Line	30
	Being Realistic toward Present and Future Trends	34

Chapter 3	Basics of Audio Power Amplifiers	37
	Safety Considerations	37
	Input Requirements	38
	Load Considerations	40
	Frequency Response	42
	Distortion	45
	Damping Factor	46
	Noise	48
	Power Output and Efficiency	50
	Phase Considerations	54
	Reliability Considerations	55
	Fundamental Audio Amplifier Architectures	58
	Negative-Feedback Terminology	60
Chapter 4	Input Stage Configurations and Analyses	63
	Functions of the Input Stage	63
	Constant Current Sources	64
	Current Mirrors	69
	Input Stage Fundamentals	73
	Evaluation of Modern Input Stage Designs	79
	Input Signal Conditioning Circuits	98
	Summary	107
Chapter 5	Voltage Amplifier Stage: Configurations and Analysis	109
	Purpose and Function of the VA Stage	109
	Common Misconceptions Involving the VA Stage	110
	Typical VA Stage Configurations	111
	Determining the Value of the Dominant-Pole Capacitor	116
	Understanding Two-Pole Compensation	118
	Optimizing the VA Stage	120
	Modern VA Stage Designs	124

Chapter 6	Output Stages: Configurations, Classes, and Device Types	141
	General Principles of Output Stages	142
	<i>Purpose and Function of the Output Stage</i>	142
	<i>Output Stage Classes</i>	143
	Class A Designs	151
	<i>Basic Class A Architectures</i>	151
	<i>Class A Biasing Methods</i>	154
	<i>A High-Performance Class A Cookbook Design</i>	157
	BJT Class B Output Stages	162
	<i>The Emitter-Follower Output Stage</i>	163
	<i>The Complementary-Feedback Output Stage</i>	169
	<i>The Quasi-Complementary Output Stage</i>	172
	<i>Output Triples</i>	174
	<i>Paralleled Output Stages</i>	177
	<i>A Summary of Class B Output Stage Characteristics</i>	180
	MOSFET Class B Output Stages	182
	<i>The Debate Over MOSFET versus BJT Outputs</i>	183
	MOSFET Output Stage Configurations	187
	IGBT Output Stages	192
Chapter 7	Stability, Distortion, and Performance	195
	Bias Generator Stability	196
	<i>Thermal Delays</i>	200
	Output Stage Stability	201
	<i>Internal OPS Stability</i>	201
	<i>External OPS Stability</i>	208
	Overall Amplifier Stability	214
	A General Summary of Stability Concerns	222
	Distortion Mechanisms	224
	<i>Crossover Distortion</i>	224
	<i>Large-Signal Nonlinearity (Beta-Droop) Distortion</i>	228

	<i>Switching Distortion</i>	231
	<i>Differential Imbalance Distortion</i>	232
	<i>VA Loading Distortion</i>	232
	<i>High-Power Distortion Mechanisms</i>	233
	<i>Capacitor Distortion</i>	233
	<i>Fuse Distortion</i>	234
	Slew Rate	234
	Improving Slew Rates	236
Chapter 8	Amplifier and Loudspeaker Protection Methods	243
	Safety Protection Considerations	244
	Electronic Overload Protection for Semiconductor Devices	245
	<i>Protecting Bipolar Junction Transistors</i>	247
	<i>Single- and Dual-Slope Protection Methods</i>	253
	<i>Multislope Protection Methods and Variants</i>	257
	<i>Radical Methods of OPS Protection</i>	262
	<i>MOSFET OPS Protection Methods</i>	264
	<i>Designing and Implementing OPS Protection Circuits</i>	267
	<i>Are All V-I and Multislope Electronic Protection Systems Sonically Transparent?</i>	270
	<i>Concluding Remarks on OPS Protection</i>	274
	Speaker Protection Methods (DC Offset Protection)	274
	Catching Diodes	286
	Summary	287
Chapter 9	Audio Amplifier Power Supplies and Construction	289
	An Evaluation of the Three Main Types of Amplifier Power Supplies	290
	Choosing a Power Supply Type	297
	Power Transformer Considerations	298
	Transformer EMI Problems	300

	Rectification	302
	Power Supply Fusing	303
	Reservoir Capacitors	305
	Miscellaneous Information about Power Supplies	306
	Power Supply Calculations	306
	Rail Rejection in Power Amplifiers	307
	Power Supply Wiring Techniques	308
	Crosstalk and DC Power Supplies	310
Chapter 10	Building the Optimum Audio Power Amplifier	313
	Step 1 Establishing the Construction Goal	314
	Step 2 Designing the Power Supply	314
	Step 3 Laying Out the Basic Topology	319
	Step 4 Determining the Application-Dependent Variables	324
	Summary	327
Chapter 11	Audio Amplifier Cookbook Designs and Discussions	329
	Design 1. A Basic MOSFET Design	330
	Design 2. A Versatile 1980s Vintage Amplifier Design	332
	Design 3. An Optimum Low-Distortion Medium-Power Audio Amplifier	336
	Design 4. A Low-Distortion L-MOSFET Audio Amplifier	338
	Design 5. A Low-Distortion L-MOSFET Professional Amplifier	341
	Design 6. A Mirror-Image Professional Audio Amplifier	341
	Design 7. A High-Power Professional MOSFET Audio Amplifier	344

	Designs 8 and 9. Two High-Quality General-Purpose Amplifier Designs	347
	Design 10. A Low-Distortion Emitter-Follower Amplifier Design	350
	Design 11. A High-Performance Class A Amplifier Design	350
	Design 12. The Optimum Power Amplifier Design?	352
Chapter 12	Construction Techniques and Considerations	357
	Mechanical Considerations of Thermal Dynamics	357
	<i>Thermal Resistance</i>	358
	<i>Thermal Dynamics and Heatsink Evaluation</i>	362
	<i>Thermal Dynamics and OPS Evaluation</i>	364
	<i>Thermal Overload Protection</i>	370
	<i>Thermal Dynamics and Thermal Delays</i>	372
	Printed Circuit Board Construction	374
	<i>Generating Printed Circuit Board Artwork</i>	376
	<i>Etching Printed Circuit Boards</i>	376
	Mechanical Layout of a Completed Audio Amplifier	378
	Wiring Methods for Audio Power Amplifiers	382
Chapter 13	Power Amplifier Diagnostic Equipment and Testing Procedures	385
	A Reminder about Safety	385
	Practical Considerations of Required Test Equipment	386
	<i>Computerized Analysis Equipment</i>	391
	<i>Computerized Design and Layout Programs</i>	393
	Testing Procedures for Audio Power Amplifiers	396
	<i>Evaluation Testing of Audio Power Amplifiers</i>	396
	<i>Functional Testing Procedures</i>	399
	<i>Symptomatic Troubleshooting of Personal Amplifier Projects</i>	403
	<i>Symptomatic Troubleshooting of Commercially Manufactured Amplifiers</i>	404

Set-Up Procedures for Audio Power Amplifiers	407
Load Testing of Audio Power Amplifiers	409
Appendix A Audio Power Amplifier Terminology	413
Appendix B Electronic Units and Abbreviations	441
Appendix C PC Board Artwork	449
Appendix D Sources of Information and Materials	464
Index	467

This page intentionally left blank.

PREFACE

This book is designed for audiophiles and electronics hobbyists who want to build their own high-quality audio power amplifiers. The amplifier designs contained here are not just mediocre power amplifiers; they are audiophile-quality designs, with the majority capable of significantly superior performance in comparison to commercially available amplifiers. My philosophy is simple: If you're going to invest the time and expense to build audio power amplifiers, why not build a project of exemplary performance?

I believe this book is unique in its approach. Most books devoted to audio amplifier construction have traditionally focused on one type or design topology. In contrast, I have attempted to present an honest and factual analysis of all the major power amplifier architectures, naturally progressing to the optimum design in each case. In addition, a variety of modifications are stressed for application compatibility, such as professional audio, musical instrument amplifiers, domestic hi-fi, and budget applications.

I have assumed that the reader is experienced in the fundamentals of electronics and electronic construction; however, I assume the reader to be a complete novice in the specifics of audio power amplifiers. Consequently, the principles and theory of operation begin at the most fundamental level and progress to the current state of the art. I have never assumed that the reader understands the function and purpose of any component within an amplifier design, so the specific details of every component in every amplifier schematic are fully explained. The conscientious reader will not end up with myriad confusing loopholes relating to any amplifier design in this textbook.

Design engineers and serious audiophiles will benefit from several areas of new research contained here. A portion of this amplifier design information has seldom been documented, with some of it

appearing to be totally obscure and unpublished. These subject areas include push-pull VA stage design and certain anomalies involving the physics of crossover distortion.

This book is for hobbyists and audiophiles who have been discouraged by the apparent schism between audio professionals and extravagant esoterics. It is designed to help anyone experience the ultimate in sonic quality at a reasonable expense. The concepts and principles presented are not subjective, mythical, or traditional; they are scientific and extensively supported with provable analyses. Many readers will be pleasantly surprised at the low cost involved with even the best audio power amplifiers.

Above all, I have directed this book toward people who want to experience the fun, satisfaction, and fulfillment of superb and practical electronic projects (not to mention the significant cost savings). I have personally constructed and tested the amplifier projects in this textbook, using the exact PC board artwork contained in Appendix C, so the careful and conscientious builder can be virtually assured of excellent results. Everything in this book is as accurate as theory, experimentation, simulation, testing, analysis, and late-night worrying can make it—I sincerely hope that many will enjoy it and benefit from it.

ACKNOWLEDGMENTS

As a sincere and dedicated Christian, I always try my best to remember to acknowledge my Lord and Savior, Jesus Christ, whom I believe assists me in the accomplishment of all honorable and wholesome goals.

A heartfelt thanks goes out to the outstanding group at Interactive Image Technologies, distributors of the Electronics Workbench program. While I operated at an efficiency level of two good ideas for every eight crazy ideas, I must honestly state that the people at Interactive Image Technologies were consistently patient with me, while providing invaluable technical assistance in the production of this textbook. I especially want to thank Joe Koenig and Luis Alves for helping out in many problematic areas.

The heart of this book has been beating in audiophiles for the past four decades, so the majority of the credit really belongs to many pioneers of both past and present. Progress in the audio fields is effectively a group effort, with many excellent audio engineers deserving the majority of credit. I hope my meager contributions can be another stepping stone for future progress.

I would also like to acknowledge the professional group at McGraw-Hill. I believe an author can only achieve the success allowed by the professionalism of his or her publisher. In this respect, I am certainly indebted to the dedicated personnel at McGraw-Hill.

G. Randy Slone

This page intentionally left blank.

Fundamentals of High-Power Audio Amplifiers

What Is Audio Amplification?

All types of audio information recorded for playback began as very low level electrical signals. For example, the signal levels at the outputs of microphones, musical instrument pickups, or audio tape heads will typically average out to only a few millivolts. Such *signal-level voltages* must be increased in amplitude (amplified) to become usable. Voltage amplifiers designed to accomplish this task are referred to as *preamplifiers*. For normal audio applications, signal-level voltages will be preamplified to about 1 or 2 volts RMS. This level is commonly referred to as the *line level*, and it is the common output level produced by almost all consumer audio equipment (i.e., tape decks, CD players, FM receivers, etc.). On some musical instrument amplifiers, the line-level output is referred to as the *preamp output*.

In addition to amplifying signal-level voltages, preamplifiers normally contain all signal conditioning circuits. *Signal conditioning circuits* modify, or customize, the original audio signal to accommodate

the listener's preference, room acoustics, or system idiosyncrasies. Examples of signal conditioning circuits are tone controls, equalizers, bass boost controls, reverb units, and various types of filter and phase circuits. Preamplifiers used for professional recording applications and commercial public address (PA) systems may also incorporate pan controls, delay lines, and harmonic modification capabilities. Input devices (i.e., tape deck, CD player, FM receiver, microphone, etc.) may be switched within the preamplifier circuitry.

All preamplifiers are voltage amplifiers. Their function is to condition and amplify a signal voltage to a line-level audio signal, in preparation for sending it to an audio power amplifier. In contrast, an audio power amplifier is designed to amplify a line-level voltage to a corresponding high-level voltage and current, capable of driving a low-impedance speaker (typically 4 or 8 ohms).

A high-quality audio power amplifier is said to be “transparent.” This means the output voltage is an (almost) exact replication of the input voltage, without any modifications having been made to phase relationships, harmonic integrity, transient response, or frequency response. If a “perfect” audio power amplifier could be constructed, the only difference between the line-level input signal and the output signal would be the increased amplitude at the output (both current and voltage). Any other difference between the input signal and output signal of an audio power amplifier is considered *distortion*.

This book provides the reader with the tools necessary to construct high-power, high-quality (almost distortionless) audio power amplifiers. Throughout this book, amplifier quality is equated directly with the lowest-distortion specifications, and I make no apologies for this fact. Throughout the last few decades, there has been an unfortunate trend among a minority group of audio esoterics to advocate the introduction of certain types of harmonic distortion mechanisms within audio power amplifiers. I am quite certain that I have the unanimous support of every legitimate sound engineer (at least the ones who can pay their bills) when I unconditionally state that all signal conditioning should occur at the line level (i.e., within the preamp stage or external signal processors). All audio power amplifiers should be as distortion free as possible because sonic accuracy is desirable for a host of practical and performance factors. (This subject will be discussed in more detail in Chapter 2.)

The Social and Economic Importance of Audio Amplification

It is very difficult to imagine what our world would be like without electronic audio amplification. Every radio, television, telephone, and stereo system contains one or more audio amplifiers. Imagine, if you can, the condition of our society without these devices!

Without audio amplifiers, Elvis Presley and the Beatles would have been limited to audiences within the confines of their audible vocal range. Rock 'n roll could not exist. All musical instruments would have to be acoustic, and there would be no point to recording them (you would have to have an audio amplifier to play back the recording!). Preachers could not be heard in large church buildings, dance bands would have to revert to Glen Miller's type of orchestration, and the city of Nashville would have to come up with an entirely new tourist attraction. In essence, our culture, as we know it today, would die.

The economic considerations are equally massive. Out of all possible consumer electronic building blocks, the humble audio amplifier is most common. As we have become more sonically sophisticated in this electronic age, the listening perception of the average person has increased logarithmically. When the first gramophones became the newest consumer gadgets, they were publicly acclaimed to provide the finest audio reproduction possible. Try getting someone to compliment the sound of a gramophone today! The point here is simple: The general public of today is more educated in the subtleties of good sound, and they are more than willing to pay for it.

At present, high-quality, high-power audio amplifiers capture a very substantial portion of the consumer electronics market, with the latest manufacturing targets being in the home theater and multimedia arenas. Dedicated audiophiles have increased in number since the 1960s, and the exorbitant price tags on audiophile-quality equipment prove this market to be in good health. Although not as dramatic as the consumer electronics field, the entertainment and professional requirements for high-quality amplifiers continue to prosper. Indeed, there are few homes today that do not contain at least one high-power audio amplifier system.

Definition of *High-Power Audio Amplifiers*

Throughout this book, the technical definition of *high-power* is from 50 watts RMS and up. This is my personal definition, and I use it for several reasons. First, in the 1950s, the highest-power amplifiers available were capable of producing only about 80 watts RMS into an 8-ohm load. These were commercial vacuum tube amplifiers, most commonly used in indoor movie theaters. With the right kind of speaker system (usually the exponential horn “voice of the theater” type design), 80 watts was more than adequate to enliven a large movie theater with 35-foot ceilings. The same is true today. With an efficient high-performance speaker system for the amplifier to work through, a 50-watt RMS audio amplifier can produce sound pressure levels that are on the “destructive” borderline.

Second, sheer power is not all it’s cracked up to be. Those who strive for the most powerful amplifiers are often those desiring the fastest car, the biggest gun, and the meanest dog. I know some musicians who would happily lug around a 30-kW amplifier with a crane if they could afford it! Professionals in the audio fields know that power is only one of many specifications that must be considered en masse to determine the true capabilities of any audio power amplifier. The classic audio power amplifiers are the ones that set exceptional standards in design, performance, and reliability. For the most part, maximum power output ratings have little to do with their popularity.

This book provides complete cookbook information and construction details for audio power amplifiers up to 550 watts RMS. In addition, the functional and design information contained herein provides the know-how to construct power amplifiers of even higher power ranges for those who are involved in large professional audio systems.

Definitions of *High Quality*

Quality is always a relative term, demanding a comparison to be made with other comparable equipment. In some marketplaces, quality is closely synonymous with price, but in the case of audio power amplifiers, nothing could be further from the truth. Due to the influence of subjectivism within the audio fields, a very expensive audio power amplifier may compare poorly with a similarly

rated amplifier at only a fifth of the cost! The explanation of subjectivism and its corruptive influence upon the audio industry will be discussed in Chapter 2.

There are essentially three areas of quality evaluation: performance, reliability, and construction. Considering performance, a high-quality amplifier should be extremely low in distortion (both harmonic and intermodulation) across the entire audio bandwidth. It should also have a broad subsonic and supersonic bandwidth (the reason for this will be explained later), with low-noise specifications and rock-solid stability under all practical load conditions. From the reliability standpoint, a high-quality amplifier should be able to protect itself under a wide variety of adverse conditions and operator mistakes, including output short-circuits (an absolute necessity for musical instrument amplifiers), overloads, and excessive internal temperatures due to clogged fan filters or improper ambient ventilation. In addition, the electronic design should include sufficient paralleled semiconductor power devices to ensure long-term reliability (as indicated by the semiconductor thermal cyclic curve charts) and some method of protecting the speakers from any significant level of DC. Finally, the overall construction of the power amplifier should include adequate bracing for the heavy power supply components, provide external contamination protection for the electronics, and shield the user from any injurious electrical potentials.

Unfortunately, few commercial power amplifiers incorporate all of the desirable features as detailed in the preceding paragraph. The good news is that you can build your

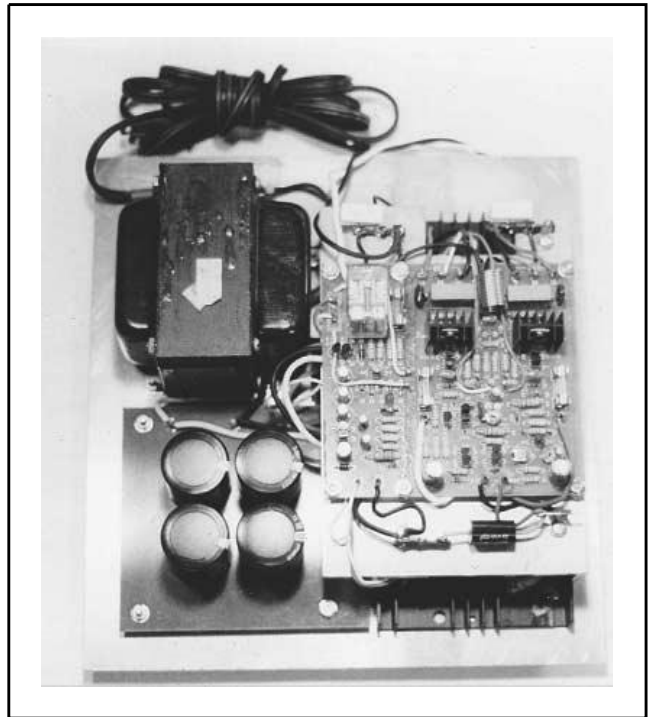

This audiophile-quality 250-watt RMS audio amplifier cost me approximately \$60 to build. The power transformer, reservoir capacitors, and large heatsinks (mounted on the backside) were all purchased from surplus companies.

own “classic” amplifier with all of the aforementioned features at about half the cost of comparable commercial units!

The Major Applications

Although all audio power amplifiers perform essentially the same function (i.e., conversion of line-level signals to high-voltage, high-current output signals), their applications are quite varied. At the consumer level, audio power amplifiers are used in home stereo systems, computer multimedia systems, and home theater applications. In addition, most musicians or vocalists acquire some form of musical instrument amplifier (a combination of preamplifier, power amplifier, and speaker, usually in a single housing) or public address amplifier for practicing their talents at home. The quality of power amplifiers intended for personal and home use can vary from superb to very poor. Buyer beware!!

Professional audio systems include public address systems, recording studio monitor and mixdown amplifiers, and commercial paging and music systems in stores or businesses. Public address power amplifiers are intended for use by professional entertainers and musicians, often in large open-air or auditorium environments. Consequently, they are usually high-power units and constructed in very rugged enclosures (due to the abuse they are expected to endure on the road).

As would be expected, recording studio monitor and mixdown amplifiers are high-performance, high-priced units. Recording studios use a variety of these power amplifiers to play back recorded tracks to studio musicians and/or play back master tapes for mixdown operations. Studio owners and sound engineers do not compromise with performance in these amplifiers since the end result of a studio session will depend on the sonic accuracy of the entire playback system.

Commercial paging and music system power amplifiers are used for employee communication within large businesses and department stores. These power amplifiers typically drive a substantial quantity

TRADE SECRET

The performance of many public address power amplifiers is not as good as the price tag would suggest, with full-output distortion figures as high as 1 percent in many cases. Potential buyers should be very careful to compare cost with performance specifications.

of small, widely dispersed speakers at low to medium power levels. Performance specifications are often very poor, but this is usually of little concern since the speaker systems will not facilitate good sound reproduction anyway. In most cases, these power amplifiers utilize a 70.7-volt transformer speaker coupling to minimize load variations.

Realistic Expectations for the Individual Builder

It is quite possible for the audio hobbyist to construct high-quality power amplifiers that will meet or exceed the performance of the best audiophile-quality units on the consumer market. In the previous sentence, I did not use the word *possible* to insinuate a sense of “luck,” nor did I intend it to mean “easy.” It’s “easy,” with a little “luck,” for almost any electronics hobbyist to cobble together some sort of audio power amplifier that works to some degree. That kind of hit-and-miss construction is not what this book is about. The construction of professional audio amplifiers does not require the builder to be a genius or uniquely talented in some exotic manner, but the builder must possess a good understanding of the electronic fundamentals and attempt a variety of amplifier projects to gain some practical experience.

In comparison to other types of electronic circuits, audio power amplifiers are unique. Due to the high current, voltage, and power dissipation requirements, past attempts at integrated circuit (IC) and “encapsulated hybrid module” fabrication of audio power amplifiers have not been very successful. In short, ICs are limited by the laws of physics from high-power applications, and hybrids suffer problems in the areas of reliability, practicality, performance, standardization, and cost. This situation is not likely to change in the foreseeable future. Consequently, virtually all high-quality power amplifiers are constructed from discrete components (with the exception of a few designs that incorporate IC op-amps at the input stage). This is good news to the individual builder because the obstacles that normally inhibit the practicality of home-built projects (i.e., SMT components, exotic manufacturing processes, and requirements for highly specialized equipment) are not usually required within the

QUICK TIP
If you are a novice at this task, I recommend a thorough study of Chapters 3 through 10 of this book, followed by a beginning project of one of the less complicated, lower-power amplifiers described in Chapter 11.

field of audio power amplifier construction. In other words, the individual builder can efficiently compete with the large manufacturers. There are very few areas of hobbyist electronics today in which this is possible.

For most people, the areas of greatest difficulty in amplifier construction will be printed circuit board fabrication and mechanical design. If you have had a bad experience in the past with attempting to make printed circuit boards, don't become discouraged. The methods described in Chapter 12 make it relatively easy for almost any enthusiast to turn out high-quality, one-of-a-kind PC boards. Mechanical design, including heatsink ventilation and enclosure fabrication, may be a little more difficult. If you are like me in that you are not extremely talented at building enclosures that turn out square, you can acquire good-quality enclosures from numerous manufacturers or surplus houses or from scavenging old equipment.

The scope of this book cannot possibly cover the basic elements of

electronic design. If you are a design engineer hoping to build audio power amplifiers from scratch (i.e., without any of the developed circuit foundations provided in Chapter 11), you will find this book very helpful in establishing the design principles to use. From there, you can insert this data into whatever simulation engine you trust, and you're in business. However, the only practical reasons I can fathom for such recreation of the wheel would be to use up a very large inventory of unusual components or to test your theory on a radical new principle of audio amplification. There are amplifier designs in this book that are capable of performing at distort-

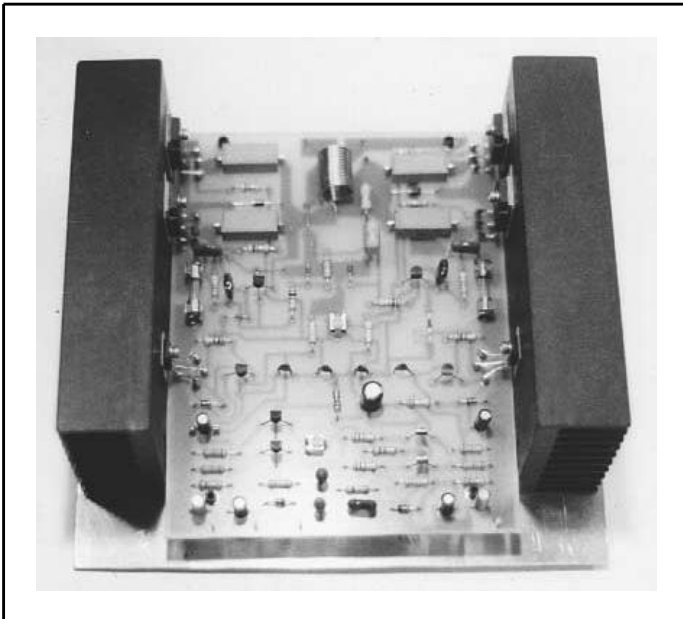

Two of these 250-watt MOSFET amplifiers can easily be installed in a large-size rack-mount enclosure (with appropriate power supply) for a professional 500-watt stereo amplifier. THD at maximum output power is approximately 0.02 percent and the cost should be less than one-half the cost of comparable commercial units.

tion levels below 0.001 percent at 1 kHz. Attempting to improve on this type of performance will place your distortion specifications into the “noise” floor, which could not provide any practical sonic improvement. In addition, the included designs have been proven to be stable and reliable.

The individual builder will need to understand how to design unregulated power supplies (i.e., raw power supplies) as applicable to a variety of audio power amplifiers. This information is detailed in Chapter 9. Also, it is important to comprehend the unfortunate overlapping meanings of *design* and *modify*. You may want to modify an existing amplifier design by incorporating DC speaker protection into the output circuit. Technically speaking, the end product will be a new “design,” but, in reality, it is simply a “modification” to an existing design. Throughout the course of this book, I discuss many types of modifications. You may want to include some of these modifications into your custom projects, or, in many cases, they can be used to improve (or tailor) the performance of commercially manufactured units.

Cost Considerations for the Hobbyist

With a little shrewdness, the monetary savings in building your own audio amplifiers can be enormous. In most cases, I find that I can build power amplifiers for about one-half the cost of comparable commercial units, with even greater savings possible depending on a number of factors.

From the suggestions that follow, you may want to consider what cost-cutting methods are applicable to your personal requirements and goals:

1. The expensive components in audio power amplifiers are the power transformers, filter capacitors, output devices, heatsinks, and enclosures. Keep a mental list of your current project(s), and watch for these items as you browse through surplus flyers, electronic magazines, parts catalogs, and electronic stores. Surplus catalogs are usually your best source for finding the lowest prices.
2. When practical, buy expensive components in quantity. Quantity discounts offered from surplus houses can be especially significant.

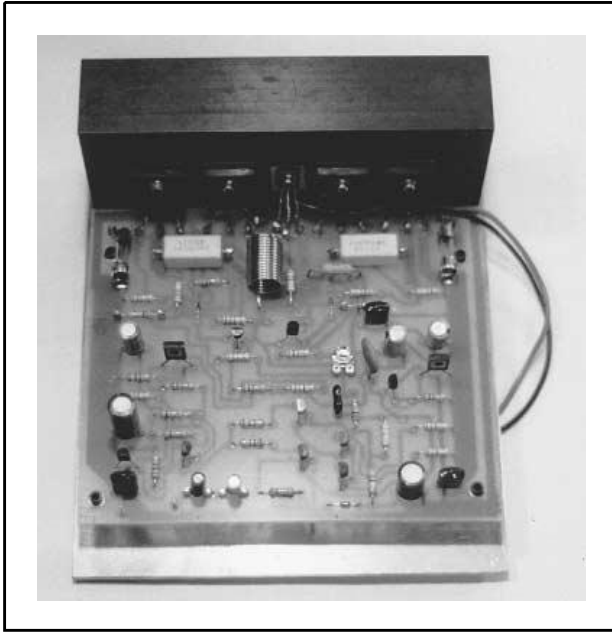

This amplifier design is capable of 0.001 percent THD at 80 watts RMS into an 8-ohm load. The approximate cost, as shown, is about \$35 (if my suggestions regarding cost consideration are utilized). This is the amplifier design of Figure 11.4.

3. Consider the possibility of modifying your amplifier design to accommodate exceptional bargains. For example, a good deal on filter capacitors may make it practical to place two or more capacitors in parallel as a substitute for a larger, more expensive capacitor.
4. Junked audio amplifiers (or other electronic equipment) may contain good, valuable components. There are many sources for electronic junk; keep your eyes open!

By incorporating the previous considerations into your normal hobby routine, the cost of constructing high-quality audio power amplifiers should average somewhere between 25 to 50 cents per watt. The rough average of commercially available audio power amplifiers is

typically between \$1 and \$2 per watt. (Currently available vacuum tube “monoblocs” can cost as much as \$100 per watt!) If for no other reason, the cost savings involved in building your own audio amplifiers is certainly a sufficient motivation for adopting the hobby.

A Few Basics about Obtaining Parts and Materials

One of my goals in writing this book was to make the high-quality audio amplifier projects contained here as inexpensive as possible, without compromising quality or performance. As a means of accomplishing this goal, I adhered to the following methodology:

- First, I centralized all of my designs around a small group of commonly available semiconductor devices. Consequently, if you decide to build some of these projects, you need stock up on only a small number of types to construct a wide variety of

amplifier designs. This also facilitates the cost advantage of buying parts in quantity. This method of component standardization has not compromised the performance of the designs to match the components. The components I standardized upon are the best-suited components available for these projects, and they are typically used in many of the highest-quality audio amplifiers available on the commercial market.

- Second, I designed the printed circuit boards to be easily adapted to a large variety of heatsinks. I have discovered that mechanical design is usually much more trying to the typical audio hobbyist than the electronic end of project completion. Since almost every electronics hobbyist has a variety of scavenged heatsinks in the junkbox, I thought it would be nice to be able to use them.
- Third, I personally designed, constructed, and tested every audio amplifier design in this book. Therefore, this book doesn't contain any projects that I designed possibly two or three years ago, accidentally forgetting to include a component, make an artwork change, or upgrade from an obsoleted component. The PC board artwork is the same artwork I used to build the projects (so there is virtually no chance of error), the designs and testing are fresh in my mind (Chapter 11, discussing and illustrating the cookbook designs, is already finished as I write this text), and all of the components and materials are currently available. From my perspective, there is nothing more discouraging than spending a lot of time and money on an electronics project, only to find that the project doesn't work—believe me, there are more of those floating around in books than you may think. I have “non-built” many of them!

This book has been designed with the following goals in the forefront: Keep it understandable to the reader, eliminate every mistake possible from the author's vantage point, and keep it as cost effective as possible without compromising on results. I hope you will agree that I have been mostly successful in these areas.

For those of you who would like to begin collecting the semiconductor devices for the projects included in this book, consider the list

QUICK TIP

Estimate your continued interest and investment in this hobby, and buy in quantity *if you think you will actually use the quantity you buy.* The object of buying in quantity is saving money—there aren't any monetary savings in wasting a large quantity of parts!

in the sidebar. Naturally, if you do not plan to build certain projects, there is no purpose in buying the components needed for them. Look through the projects you are interested in. You'll note that all of the small-signal transistors include only three types, there are only two types of predriver transistor pairs, and the output devices include two types of bipolar junction

transistor (BJT) complementary pairs and one type of metal-oxide semiconductor field-effect transistor (MOSFET) complementary pairs.

The list in the sidebar contains all of the specific types of semiconductor devices used in constructing the audio amplifier projects presented in this book. They are not difficult to find, but they may not be available at your local electronic parts store. The idea here is to give you some advance notice to aid you in browsing through a few component and surplus catalogs and provide you with time to get the necessary components ordered and received before you're ready to begin construction. The remainder of the electronic components needed (i.e., resistors, capacitors, general-purpose diodes, etc.) are available at almost any electronics dealership.

Income Opportunities for the Professional

More and more consumers, especially audiophiles, are becoming aware that skilled and conscientious power amplifier builders can produce a better product than many commercial manufacturers. This has created the myth believed by many consumers that virtually all home-brew power amplifiers are better than store-bought units, which is certainly not the case. In any event, there is a growing market for individually crafted power amplifiers, so if you become proficient enough at your hobby, there is a professional direction to take it. Many of today's well-known commercial manufacturers started out as small, single-person operations.

Most persevering hobbyists eventually find themselves in a comfortable semiprofessional situation. They sell some of their custom-built power amplifiers to friends and acquaintances, and they invest the profits back into their hobby. Eventually, they wind up in the envi-

able position of having the most elaborate audio system in the neighborhood, with enough money left over to buy popcorn!

A predictable result of building audio power amplifiers is that the hobbyist acquires the know-how and experience to repair them. Audio power amplifiers have the highest failure rate of any audio system building block. This will almost always be the case since the audio power amplifier handles all of the significant power within the system. I am not suggesting that you could establish a full-time career in such a narrow and specific field, but it is certainly a viable part of any consumer electronics service business. Again, hobbyists can easily pay for their hobby expenses with a little repair work on the side.

MATERIALS

SMALL-SIGNAL TRANSISTORS

2N5551 (*npn*-BJT)
 2N5401 (*pnp*-BJT)
 2SK30 (*n*-channel JFET)

PREDRIVER TRANSISTORS

2SB649 and 2SD669 (BJT complementary pair)
 TIP31C and TIP32C (BJT complementary pair)

OUTPUT DEVICES

MJ15003 and MJ15004 (BJT complementary pair)
 2SC3281 and 2SA1302 (BJT complementary pair)
 2SK1058 and 2SJ162 (L-MOSFET complementary pair)

ZENER DIODES (1/2 WATT)

3.9 volt
 4.4 volt
 18 volt
 24 volt

This page intentionally left blank.

Misinformation in Audio

Science versus Subjectivism

A *subjective attitude* is one in which the person relies on his or her senses, thoughts, and feelings. While the majority of our understanding and behavior depends on subjectivism, it is often in direct conflict with known scientific fact. For example, if we simply stand and observe our local environment, the earth appears to be flat and we appear to be motionless. In truth, of course, the earth is round, and we are all moving at a speed of well over 1000 miles per hour relative to any stationary point in space.

As a principle of living, subjectivism is good. I certainly do not want to imply that I consider subjectivism to be wrong in and of itself. However, while other areas of electronic design have advanced, and continue to advance, based on verifiable scientific principles and developmental techniques, the consumer audio industry has been severely compromised by subjectivism. In addition, the subjectivist position poses an immediate conflict for anyone hoping to build high-quality, high-performance audio power amplifiers.

What Is the Subjectivist Position?

Subjectivists believe audio power amplifiers are extremely complex and difficult to design, with predictable outcomes a virtual impossibility. In

QUICK TIP

The amplifier simulation step provides a quick and simple method of eliminating minor mistakes prior to designing the printed circuit board artwork.

their opinion, even the best designs are somewhat enigmatic, with good results depending on many unscientific principles and very expensive methodologies. Subjectivists also believe that excellent sonic reproduction contains a host of immeasurable nuances, impossible to measure or

observe with electronic analysis equipment. Consequently, the die-hard subjectivist treats statistical analysis with contempt, preferring to rely on some form of nonstandardized listening performance evaluation.

In reality, the design of excellent audio power amplifiers is a very predictable affair. As proof of this statement, consider my personal experience with all of the amplifier designs provided in Chapter 11 of this book. I began each design with a cost, complexity, and performance goal. After putting my initial design on paper, I entered it in a software simulation program (i.e., the *SPICE 3* simulation engine provided in the professional version of *Electronics Workbench*).

After construction, *all* of the amplifier designs performed precisely as predicted. During the testing phase, I elected to change the compensation capacitors in one design to improve stability, and I accidentally blew up one design by reversing the polarity of the power supply (unfortunately, many years of experience is not a barrier against dumb mistakes!). This error required the replacement of six destroyed components. Other than these two cases, I didn't need to make any further component changes in any of the amplifier designs, and every amplifier functioned as expected during its initial testing. So much for the misguided notion that audio power amplifier design is not predictable!

In addition, I would like to make it clear that I am not some type of audio wizard or genius regarding audio power amplifier design. Any competent electrical engineer or electronics technician equipped with an adequate knowledge of power amplifier basics and experienced in mediocre electronic design fundamentals should be able to achieve similar results.

Note: Please note that audio power amplifier design is not the primary theme of this book. However, it is very probable that many readers will utilize the functional and design information contained herein for design purposes. With a little time and experience, I believe this

goal is achievable to varying degrees, depending on the talents and resources of the reader.

The belief that original audio program material contains immeasurable qualities has been proven false. The most notable examples of this are probably Peter Baxandall's cancellation technique ("Audible Amplifier Distortion Is Not a Mystery," *Wireless World*, November 1997, pp. 63–66) and Hafler's straight-wire differential test ("A Listening Test for Amplifier Distortion," *HiFi News and Review*, November 1986, pp. 25–29). Both of these tests utilize a method of canceling an amplified audio signal with its own original signal. The absence of any residuals proves the absence of any mysterious immeasurable components.

Even without Baxandall's and Hafler's proofs, it is reasonable to conclude that the subjectivist viewpoint of this matter is a fallacy. All audio power amplifiers are utilized for amplifying the audio program material stored on or transmitted via some form of sound medium (i.e., vinyl records, audio tape, compact disc, FM reception, etc.). This means the audio signal has already passed through dozens of preamplifier and filter stages during the process of recording and/or transmitting. If elusive audio subtleties were actually degraded by solid-state processing, as many subjectivists claim, how could they even exist on the sound medium? Obviously, the subjectivist concept of this issue is inaccurate.

As a general rule, subjectivists reject objective measurements of audio amplifier performance in favor of subjective impressions from listeners within the confines of nonstandardized listening environments. There are a number of severe problems with this form of subjective impression assessment. First, and most obvious, is that each listener's perception is unique. Second, for any form of comparative analysis, a baseline, or standard, must exist. To date, I am not aware of any standard power amplifier used for comparison in these tests. Third, comparative analysis requires a uniformity of support equipment and program material. In my experience, I have noticed that subjectivists use different types of speakers, preamplifiers, and programs in a wide variety of acoustic environments for performance

QUICK TIP

The methods and details of both of these tests are covered in detail in Douglas Self's excellent book *Audio Power Amplifier Design Handbook*, 1996, Newnes Publications, 1996 (ISBN: 0-7506-2788-3).

evaluations. Valid evaluations are simply impossible under such variable test conditions. And finally, in most cases, the listener is exposed to all of the details of the *amplifier under test* (AUT) before the listening evaluation. In other words, it is probable that the person performing the listening evaluation will already have preconceived ideas of the amplifier's performance before the evaluation. For human beings, it is difficult, if not impossible, to keep personal bias from affecting ultimate judgments.

For subjective impressions to be utilized as a viable and unbiased method of power amplifier performance evaluation, there would need to be a group of knowledgeable evaluators instead of a single person. A standard audio system (i.e., preamplifier, power amplifier, and speaker system) given the task of reproducing a standard audio program would be placed in a specially designed, acoustically dead evaluation room. The evaluators would not be informed of any of the details regarding the amplifier under test, and they would not know whether they were listening to the standard power amplifier or the amplifier under test during various phases of the evaluation. Unfortunately, most subjective listening tests are currently being performed with no controls in place, which renders them worthless.

The inaccuracy of subjective listening impressions has contributed to a host of misinformation in the audio field. The process goes something like this: A notable audiophile will evaluate a new audio power amplifier for an audiophile magazine on the basis of a listening test. If the audiophile gives a rave review of the amplifier, a conjectural opinion involving some unique new design approach may be given as the reason for the exceptional performance. For example, the reviewer may give credit to the deletion of a certain type of coupling capacitor. In the following months, various other audiophiles may provide complimentary reviews of the same power amplifier, claiming subtle improvements indefinable within the constraints of analytical interpretation (after all, no one wants to be kicked out of the unofficial golden ear club!). It is probable these succeeding critics will also point toward the deleted capacitor as a culprit of sound integrity. Shortly thereafter, a technical writer for another audiophile periodical will write an article condemning the notorious capacitor, supporting this opinion with many previous articles describing a mysterious sonic degradation (imperceptible to distortion measurements) inherent within capacitors.

Eventually, several manufacturers may remove the suspect capacitor from their designs in the effort to appeal to the current marketplace trend (the validity of a design change is totally irrelevant to a sales or marketing department). Finally, the notable audiophile who wrote the original review and initially focused on the absent capacitor is now “proven” right by majority consensus.

I hope you noticed that there wasn’t anything scientific or objective in the previously described process of “development.” Even though my little story is only hypothetical, I have recognized the identical outrageous methodology time after time within subjectivist circles. As proof of this statement, consider the sidebar list of audio “concepts” (“heresies” would be more appropriate) supported by many subjectivists.

Much of the current skepticism regarding high-negative-feedback factors is the result of an elusive phenomenon known as *transient intermodulation distortion*, or TID. The concept of TID probably evolved as a misunderstanding of two commonly known characteristics of inadequate input stage design—the *current starving* of the input stage at increased frequencies and the combined loss of linearizing negative feedback at high frequencies (these problems will be discussed further

- **“Monoblock (sometimes spelled *monobloc*) vacuum tube (i.e., valve) amplifiers provide the ultimate experience in pure sonic quality.” *False!* In reality, it is difficult to get much further from the truth. A typical direct-heated triode single-ended (abbreviated DHT-SE) monoblock amplifier will output only about 10 to 25 watts RMS with around 2 percent total harmonic distortion (THD) and cost about \$1500! From any objective evaluation perspective, the performance of such an amplifier is terrible.**
- **“Monoblock construction (i.e., monaural amplifiers in individual enclosures with dedicated power supplies) always provides audible sonic improvement.” *False!* The primary motivation behind monoblock construction is the elimination of crosstalk. It is easy and much less expensive to construct multiple power amplifiers in a singular enclosure (with a singular power supply) and achieve crosstalk specifications over four *times* better than the required minimum audible level.**





- **"Tone controls (in preamplifier stages) will always degrade sonic performance." *False!*** It grieves me to imagine the number of audiophiles who have gone to the considerable expense and trouble of trying to match a speaker system to the unique room acoustics of their listening area without the aid of tone controls. The original program material was enhanced with a host of tone controls, equalizers, delay units, and probably other forms of sound processing units before it ever left the sound studio. The claim that program material is somehow magically degraded in the final playback process is totally unreasonable.
- **"Various types of metal conductors in the audio signal path will affect sonic quality, with precious metals, usually gold, being the most desirable." *False!*** Provided that a conductive metal is free from corrosion or insulating contamination, the type of metal used for a conductor in an audio power amplifier has absolutely nothing to do with sonic quality. I have read technical articles claiming that each type of conductive metal (i.e., copper, gold, silver, etc.) has its "own" characteristic sound when placed in an audio signal path. Such a ridiculous claim contradicts many proven and established fundamentals in about four major branches of the physical sciences!
- **"Negative feedback is a necessary evil. The more we can reduce negative feedback, the better a power amplifier will sound." *False!*** Negative feedback is a good thing and improves virtually every known performance characteristic of audio power amplifiers. Elaborately complex schemes have been developed to reduce negative feedback (i.e., servo amplifiers, low open-loop gain designs, nested feedback arrangements, etc.) without any significant improvement in performance that I am aware of. In addition, these designs are usually accompanied with some pretty severe disadvantages, including instability, greatly increased distortion, and unwarranted complexity.

in Chapter 4). These two effects, when combined, result in a sharp 18-dB/octave increase in harmonic distortion. This high distortion rise is prominent in high-frequency music transients, so it has been misinterpreted and classified as a newly discovered audio parameter. Hence, "transient intermodulation distortion" was born. High-gain and high-negative-feedback factors have been suspected of being the culprit

behind TID generation, based on the assumption that too much of any good thing has to be bad, even if the effects are not readily noticeable.

The list in the sidebar is only a sampling of the subjectivist viewpoint; I could have included many other erroneous concepts. In addition to the foundational errors involved in subjectivism, notice that the “corrections” involved to achieve the subjectivist’s concept of “pure” sonic quality are *very expensive*. Experimentation is fine; however, the majority of consumer audio equipment is purchased by typical consumers who trust in professionals to give them accurate advice regarding the best sound for their money. I consider it a cruel injustice that an ill-informed audio enthusiast will save up for a year to purchase a \$3000 set of monoblock vacuum tube amplifiers and end up with an audio system that would have been considered poor as far back as the 1960s!

The recommendations and opinions of the subjectivist perspective are not a matter of “taste,” as many would have you to believe. Hypothetically speaking, if I constructed an audio amplifier with a very poor bass response, I could rationalize its use by saying that too much bass spoiled the delicacy of the high-frequency response. (This is highly reminiscent of the sour-grapes scenario!) Regardless of how I choose to justify it, it’s still a poor amplifier. The point is, any type of sonic coloration should always be performed at the *line level* where it can be *turned off!* An audio power amplifier exhibiting 2 percent THD will always exhibit 2 percent THD, and its distortion performance will always be around 200 *times worse* than many high-performance amplifiers currently available. There are a wide variety of outboard sound processors to simulate virtually any acoustic taste, including vacuum tube sound. Therefore, the decision to abide by the subjectivist opinion and purchase an enormously expensive high-distortion power amplifier is not a matter of taste; it’s a matter of poor judgment involving the wrong method and place to interject the listener’s personal preferences. After all, I could choose to dim the lights in my house with a 3000-watt rheostat, but I’m sure my method would be condemned by anyone familiar with thyristor power control!

QUICK TIP

Actually, negative feedback is a very good thing. The more negative feedback we can realistically inject into an audio power amplifier design without encountering stability problems, the better the power amplifier will perform in almost every aspect.

Truths and Practicalities Involving Audio Power Amplifier Specifications

I first became interested in audio engineering back in the late 1960s while I was attending college. In those days, it was widely accepted that the minimum THD detectable by the human ear was about 0.1 percent (just a decade earlier, the same claim was made for 1 percent THD). For a while, 0.1 percent became the magic number for many manufacturers, and the majority of consumers considered anything less than that as irrelevant. This was also a time when semiconductor manufacturers were starting to produce some exceptional-quality high-power complementary pair BJTs and audio designers were perfecting the early high-performance designs. Rock ‘n roll had become very loud, motivating several classic designs to evolve in the effort to fill this marketplace. (I can remember daydreaming over magazine pictures of the first Phase Linear 700 amplifiers. Unquestionably, the audio bug bit me at an early age!)

It seems reasonable that the many facets of the audio industry would have standardized upon various specifications defining audio excellence during the last three decades. However, while organizations such as UL, CSA, IEC, FCC, and VDE have established certain regulations regarding power consumption, emission, and safety, there has been little headway in establishing baselines for acoustic and performance standards (various attempts at this, such as the DIN standards, have not been very successful for a variety of reasons). Typically, audiophiles have followed a simple trend of “more is better” in regard to power output and frequency response, “less is better” regarding harmonic distortion and noise, and “faster is better” in reference to slew rate.

The goal of this book is to provide the reader with the academic tools necessary to construct the highest-quality audio power amplifiers. However, there are limits of practicality whereby the improvement of one performance characteristic will undermine another. Therefore, the optimum (not perfect) audio amplifier will represent a compromise of a variety of factors to promote the best overall performance. For example, let us assume that we can increase the high-end frequency response of a hypothetical amplifier from 80 to 400 kHz by adding another voltage amplifier (VA) stage. A push-pull VA stage will require at least four additional transistors (usually six). These addi-

tional transistors will decrease the statistical reliability of the amplifier by about 10 percent. The increased frequency response will certainly increase the risk of high-frequency instability problems under indeterminable loading conditions. This means the tweeters in any speaker system used with this amplifier will be living on borrowed time, together with the Zobel network of the amplifier itself. Again, this reduces the reliability parameter of the amplifier even further. And finally, the additional VA stage will represent an increased cost, increased complexity, and increased assembly time. The irony of this situation is that the actual sonic performance of the amplifier will not be improved at all (even if you happened to be five years old and have never been exposed to a loud sound and your father is Superman). In other words, what may appear to be an improvement upon first consideration may turn out to be exactly the opposite in reality.

Based on the previous discussion, our first priority is to determine some general statistics for audio excellence and use them as a target for our construction goals. Obviously, these baseline statistics will vary somewhat depending upon the application of the amplifier. This will be explained in greater detail later on in this book.

For harmonic distortion, a simple statement of a numerical percentage is, for several reasons, grossly inadequate for the serious audiophile. First, the standard frequency used for harmonic distortion measurements is 1 kHz. As we will discuss later in this book, a typical Lin design audio amplifier will be expected to increase in harmonic distortion at a rate of approximately 6 dB per octave (or a little less in actual practice) in a relatively linear fashion. This means that if we start with 0.1 percent THD at 1 kHz, we can expect the THD to increase to around 1 percent by the time we reach the end of the audio frequency spectrum (that is, 20 kHz). As a rule of thumb, I usually estimate that the 1-kHz distortion measurement will be about 10 times higher at 20 kHz, and this is typically pretty close.

Note: This rule of thumb is applicable only to amplifiers utilizing single-pole compensation methods. Compensation and distortion will be discussed in more depth later.

Many manufacturers specify THD at a 1-watt RMS output. Obviously, this THD specification will increase dramatically as the amplifier is

fully loaded. Generally, I become suspicious of manufacturers who provide only a low-power specification for THD.

Another factor in harmonic distortion evaluation is the *harmonic content* of the distortion. Second-order harmonic distortion is actually pleasing to many listeners, adding what most people describe as warm or full-bodied characteristics to the audio program. (The distortion content of vacuum tube amplifiers is primarily second order, which explains much of the subjectivist affection for them.) In contrast, third-order harmonic distortion is extremely dissonant to the human ear, and this continues to be the trend as the order is increased. Crossover distortion, therefore, becomes a major culprit to sonic quality since virtually all of the harmonic distortion created in the crossover region is high order. It has been proven that the human ear is capable of detecting crossover distortion as low as 0.3 percent. However, with low-order harmonics, the perceivable level is about 1 percent. It is feasible to experience a situation wherein an amplifier with relatively high THD will sound superior to another amplifier with much lower THD specifications, the reason being that the first amplifier's distortion content was primarily low order.

A final factor involving harmonic distortion is the tendency for THD to increase in BJT designs as the load impedance decreases (for example, when changing from an 8- to a 4-ohm load). This is a result of the *beta-droop effect* in BJT output stages (MOSFET output stages do not suffer from this effect). We will discuss this phenomenon in detail later on in this book.

QUICK TIP

As a rule of thumb, I try to target all of my amplifier designs to perform in the range of 0.01 percent THD at 1 kHz, fully loaded. In this way, the THD should never exceed about 0.1 percent within the audio spectrum (i.e., at 20 kHz), and this is close to a factor of three times below the perceivable limits of the human ear, even if the type of distortion is worst-case high-order harmonics. The high-quality cookbook designs presented in this book are all in the 0.01 percent ballpark (with several designs closer to the 0.001 percent mark), and the distortion content of the mirror-image designs is predominantly second order.

Frequency response is a little easier to establish a baseline for. In general, any audio power amplifier with a -3 -dB bandwidth of 3 Hz to 40 kHz is good, and any amplifier with a bandwidth of 3 Hz to 100 kHz is excellent. I personally consider any DC-coupled amplifier or any amplifier with an extreme high-end bandwidth to be an accident waiting to happen.

It is virtually impossible for me to provide accurate noise specifications for the designs in this book because noise performance depends on the enclosure type, power supply placement, and wiring methods. However, noise reduction techniques for implementation at the input stage design will be discussed since this is the major source of design-related noise problems. If good construction practices are followed, all of the included high-performance designs should provide noise levels at or better than -90 dB. Since the breathing of most listeners will be louder than this, I consider it to be more than satisfactory (I know few audiophiles who give up breathing to listen to their music).

There is much controversy and misunderstanding involving slew rate. The concept of slew rate and the associated controlling factors will be discussed later, but for now, allow me to state that my rule-of-thumb design target is approximately 40 V/ μ s for most medium-power audio amplifiers.

The output power rating of an audio amplifier is, of course, a personal choice. However, as I stated earlier in Chapter 1, the actual acoustic energy level (that is, the sound pressure level, or SPL) of any audio system is going to be determined by the speaker system efficiency as well as the power rating of the amplifier. Since there is little difference in the cost factor between some of the most efficient and some of the least efficient speaker systems, it seems preferable to me to invest in an efficient speaker system and a lower-power amplifier.

Vacuum Tube versus Solid-State Designs

Although some areas of the tube versus solid-state controversy have already been touched on, I hope this section will shed a little more light on the subject.

There are a variety of reasons that many audiophiles prefer vacuum tube (i.e., valve) audio power amplifiers to solid-state designs. The most probable reason is that tube amplifiers naturally produce a relatively high percentage of second-order harmonic distortion. In musical terms, a second-order harmonic is always one octave above the fundamental frequency, so the tones can never become dissonant with the program material. The sonic effect of adding second-order distortion is similar to hearing two musical tones instead of

one, simulating a perception of body or character to the original program material.

In contrast to solid-state output devices, vacuum tubes do not transcend into cutoff, or saturation, modes in the abrupt fashion of semiconductor devices. Vacuum tubes have the tendency to roll off into operational extremes in a more gradual manner. To the listener, this provides two sonic differences. First, the harsh semiconductor effects resulting from *overdriving* or high-level transients, simply add to the body of the music in vacuum tube designs. Second, the nonlinear behavior of tubes near the operational extremes tends to “squash” the audio signal, similar to a pseudo-compression circuit. Again, this can provide a warm, pleasing quality to the program material totally unlike that which would occur in a solid-state design. Vacuum tube enthusiasts often classify solid-state sound as “harsh” or “transparent,” whereas they consider tube sound to be “warm.”

It is true that solid-state sound is transparent, and that is *exactly* the way we want it to be. A pleasing sound is not a measure of performance when accuracy is desired. After all, both a flute and a singing bird produce pleasing sounds, but I don’t want birdcalls to sound like flute solos. High-quality audio should always begin with unaltered reproduction! A midrange instrument, such as an electric guitar, will sound fine when played through an amplifier with high second-order harmonic distortion. However, if you try to reproduce the complex sounds of modern keyboards through the same amplifier, the sonic quality will become “muddy” and often lose important subtleties. When used for public address applications, any kind of harmonic distortion can add to regenerative feedback problems. And from a personal perspective, I want to listen to the program material exactly the way the studio engineers designed it to be appreciated. If it is desirable to color the original program material with the addition of second-order harmonics, that can always be accomplished later according to personal taste. I am aware of external preamplifiers designed for this task starting at about \$80.

Trying to use vacuum tube amplifiers for surround-sound applications will usually provide inferior results compared to solid-state designs. It has been suggested that the increased distortion and phase variations produced by the output transformers interfere with the effectiveness of many surround-sound processors, but I cannot sub-

stantiate this on the basis of objective analysis or experience. Clearly, this is an area open for further research. It goes without saying that the cost involved with obtaining four (or more) vacuum tube amplifiers for surround-sound systems is automatically prohibitive to the majority of consumers.

In discussing the vacuum tube versus solid-state controversy with many vacuum tube enthusiasts, I have become convinced that their love for vacuum tubes transcends the pursuit of a certain sonic quality. For many, it is a nostalgic attraction; they want to listen to music the way it “used to sound.” Vacuum tube amplifiers also have a powerful aesthetic appeal—the warm glow of the tube filaments and attractive chrome-plated front panels seems to put the listener in the mood for music. Many audiophiles develop the urge to custom-build some of their equipment. For the novice hobbyist, vacuum tube amplifiers are typically easier to build, surviving many goofs and wiring errors that would convert a solid-state amplifier to a mass of sizzling junk in a matter of a few milliseconds. I have talked to numerous audiophiles who claim to be very successful at building tube amplifiers but who admit total failure with solid-state designs. And finally, there is a myth (originating from many poorly designed solid-state amplifiers of both the past and present) that solid-state amplifiers are more prone to blow up. I admit that there is some viable justification for this belief but only because many solid-state power amplifiers are designed without adequate protection circuitry.

There are many good reasons for harboring a love and appreciation for vacuum tube amplifiers—I also have similar feelings. I can vividly recall a childhood memory of being totally fascinated with my uncle’s old Ampeg vacuum tube guitar amplifier. The blue glow from the 6L6 tubes, the acrid smell of burning phenolic, and the wonderful sounds emanating from this magical box will always hold a valuable place in my fondest memories. However, all the fond memories and attractive qualities of vacuum tube amplifiers have nothing to do with sonic quality and performance standards. In this respect, vacuum tube amplifiers can’t even begin to compete with solid-state designs.

For comparative purposes, allow me to describe the performance specifications of a high-quality vacuum tube amplifier kit currently being marketed by one of the largest and most respected electronic kit suppliers in the world.

Note: These performance specifications were provided in the March 1996 issue of *Glass Audio* magazine.

The amplifier chosen for this example is a stereo vacuum tube power amplifier, rated at 95 watts RMS per channel, with a current selling price of about \$1100. The manufacturer's THD specification at full-power output is 0.63 percent at 1 kHz. However, at 20 Hz, the amplifier's maximum output power drops to only 40 watts, and the THD increases to 3.0 percent (the power rolloff is due to the reactive nature of the output transformer). On the upper end of the audio spectrum, the maximum power output at 10 kHz tested out at 84.5 watts, and the THD measured 2.65 percent. At 20 kHz, clipping occurred at 66 watts with a THD measurement of 5.6 percent. By modern objective sonic accuracy standards, this is a very poor amplifier. Please keep in mind that this amplifier does not represent some kind of worst-case example. On the contrary, the quality and performance is probably above average in comparison to other modern vacuum tube amplifiers (certainly superior to DHT-SE monoblock designs).

While THD measurements are our primary concern in evaluating sonic quality, there are other severe disadvantages associated with vacuum tube audio power amplifiers. The following list is a good summary:

- Vacuum tube amplifiers cost anywhere from 3 to 10 times as much as solid-state designs.
- Vacuum tube amplifiers are heavier and bulkier than solid-state designs due to the increased size and volume of the vacuum tubes and additional transformers.
- Vacuum tube amplifiers are more fragile than solid-state designs due to the fragile nature of the vacuum tubes. I challenge anyone who disagrees with this statement to take any vacuum tube power amplifier and put it through the abusive routine seen by the typical high-powered stage amplifier used by professional entertainers on tour.
- Vacuum tube amplifiers do not provide any protection against continuous short-circuit conditions at the output. Speaker impedance (i.e., either 4 or 8 ohms) must be matched to taps on

the output transformer, and most tube amplifiers are not as versatile as solid-state designs at driving a wide variety of loads (2- or 16-ohm loads, for example).

- Vacuum tube amplifiers waste more energy than solid-state designs, due to the necessity of heating the tube filaments.
- Vacuum tube amplifiers exhibit poorer reliability characteristics than well-designed solid-state units. I believe some qualifying terms must be added to this statement for an accurate understanding. There is a myth among the esoteric audiophile community that properly designed short-circuit protection in solid-state amplifiers has an undesirable effect on sonic quality. Consequently, many high-end (“high-expense” would be a more accurate adjective) audio power amplifiers have been designed without short-circuit protection. In most cases, a vacuum tube amplifier can survive a short-circuited output for a few seconds without any ill effects, but a solid-state output stage is destroyed by the time you see the spark. To add to the problem, many manufacturers have designed solid-state amplifiers in such a way that the output devices normally operate close to their maximum temperature parameters (a cost reduction method). This design technique literally assures poor reliability characteristics (which can easily be proven by examining the output device thermal cyclic curves) and has done much to undeservedly harm the reputation of well-designed solid-state amplifiers.
- The reactive nature of the output transformer in vacuum tube amplifiers will produce significant phase shifts of the audio signal, especially at the upper and lower ends of the audio spectrum.
- The relatively high output impedance of vacuum tube designs (typically in the range of 0.5 ohm) produces low-damping-factor (DF) specifications. While DF values can be considered more or less irrelevant in solid-state designs, the low-DF characteristics of many vacuum tube amplifiers are cause for concern in the degradation of speaker dynamics.

The only automatic advantage that tube amplifiers have over solid-state designs is the impossibility of applying any DC potentials to the speaker system. This is due, of course, to the fact that all vacuum tube

designs must incorporate an output transformer. However, virtually all high-quality solid-state power amplifiers incorporate some form of reliable DC speaker protection, so the vacuum tube advantage in this case is easily compensated for.

As a final consideration before putting this controversy to rest, I believe the example provided for us by professional sound engineers is very important. Sound engineers working in recording studios pay exorbitant money for the best high-end audio equipment. Their livelihood depends on the highest-quality sound obtainable at any price. Let me assure you that if vacuum tube amplifiers produced a higher-quality sound than solid-state designs, every recording studio in the world would be loaded with vacuum tube power amplifiers. As it stands, except for the occasional vacuum tube guitar amplifier, vacuum tube power amplifiers are virtually unheard of in recording studios.

Marketing Considerations: The Bottom Line

The function of a marketing department within a large manufacturing company is to determine what the general public wants to buy. Back in the 1950s, when it became fashionable to put holes in the sides of automobiles, the marketing departments for all of the large automotive manufacturers informed the engineering departments that the public wanted holes in the sides of their vehicles. Pretty soon, virtually all new cars had holes in their sides. There wasn't any real purpose for the holes; it was simply a fad.

Likewise, the audio industry has gone through many fads throughout the last three decades of prosperity. In general, manufacturers of high-end audio equipment are not overly concerned with the engineering or functional viability of such fads. The bottom-line goal is to sell their products and remain competitive. While some fads are based on tangible quality improvements, some are synonymous to drilling holes in the side of your car. I am a supporter of the free-enterprise system of competing for the public's affection. In general, it keeps prices down, quality high, and engineering progressive. But, from the audiophile's perspective, it's nice to know the difference between the fads that represent real performance improvements and the fads that are mostly meaningless.

The following is a general list of practical recommendations. I am providing this as an experience-based method of assisting the reader in saving money. There are always exceptions to any generality, and this list, together with my associated comments, should not be misconstrued as criticizing any person or manufacturer. I believe the audiophile's primary goal should be to accomplish his or her goals in the least expensive manner, and then if it is desirable to gild the lily, the finished product is open for modifications or experimentation according to the builder's opinions. I see no viable purpose in blanketing the fun of audio projects with excessive expense at the onset.

1. A well-designed audio power amplifier should exhibit very low noise characteristics without using expensive low-noise resistors. Also, the use of "critical-value resistors" seems to be pointless within the majority of design processes, so I avoid it whenever possible. Experience has taught me that the audiophile will have highly satisfactory results incorporating standard 10 percent tolerance, carbon-film resistors.

2. I do not believe the listener will experience any discernible improvement in noise characteristics by incorporating low-noise BJTs or FETs in the input stages of the designs included in this book. I agree that low-noise transistors will provide an improvement in measured statistics, but there are many commercially available high-quality power amplifiers that do not incorporate low-noise transistors in their input stages, and many of these amplifiers have very impressive noise specifications.

3. The critical nature of capacitors is almost always overemphasized. In high-powered amplifier designs, I like to use metalized polypropylene capacitors for input signal coupling due to their high-reliability characteristics (any DC applied to the input of a high-power audio amplifier can be catastrophic). In medium- to low-power designs, I believe "back-to-back" tantalum capacitors are adequate. In my experience, I haven't found any discernible difference between metalized polypropylene capacitors from a well-known manufacturer and less-expensive MP capacitors from a more obscure manufacturer. And finally, it is simply a waste of money to incorporate expensive capacitors in the areas of circuit design that are not in the signal path. For example, standard aluminum electrolytics are totally adequate for filtering zener diodes in constant-current sources or cascode designs.

4. In power supply designs, shielded power transformers will provide near-equal results with toroidal power transformers. I like to use toroidal power transformers in most of my projects because of their lower weight and reduced EMI characteristics. In many cases, however, typical E+I laminated transformers are much less expensive and will provide excellent results, provided that the transformer is shielded and mounted a reasonable distance from sensitive wiring and input stages. (*Note:* In the case of commercially marketed audio power amplifiers, E+I laminated transformers may not meet the required emission codes for some countries.)

5. The size of reservoir capacitors used in power supply designs does not need to be nearly as large as is specified in many esoteric power amplifiers. My rule of thumb on this controversy is about 1000 μF of total reservoir capacity per each voltage per every 10 watts of output power. Therefore, the two reservoir capacitors (that is, +V and -V filter capacitors) required for a 100-watt RMS power amplifier would be about 10,000 μF each. Not only does going to extremes in this area become highly expensive, but it can also lead to some real problems with AC line surges.

6. For many years now, audiophiles (both objective and esoteric subjectivists) have had the tendency to frown on placing any form of relay contacts or fuses in the signal path. These feelings have led to the development of some very expensive and exotic protection systems. Unfortunately, many of these protection systems do not function very well, and, for safety reasons, it would be considered illegal to place them on the open market. In some amplifier designs, adequate fusing may be provided in the power supply rails, thus eliminating the need for a safety fuse at the speaker output. However, the argument that speaker output fuses interfere with the damping factor (thus degrading sound quality) is not substantiated, as we shall discuss in later chapters. For the majority of audio power amplifiers, relays are the best and least expensive way of protecting the speakers from destructive DC potentials. Most of what has been published within audio circles in criticism of output relays is not true, and the valid criticisms are easily dealt with. Fuses and relays in speaker output circuits provide a cheap and versatile “no-power” failsafe. In well-designed amplifier circuits, there isn’t any good reason not to use them.

7. Speaker cables seem to be in the audiophile limelight these days. A good speaker cable should be reasonably rugged and capable of conducting the highest possible speaker current with negligible resistive loss. Other than these two factors, I find little else to discuss about speaker cables. In comparison to moderately priced speaker cables, the expensive *low-reactance cables* currently being publicized will not affect perceivable sound within a home audio system in any way. The typical reactance inherent to the crossover in most speaker system designs will totally swamp negligible reactance differences in speaker cables. The only extreme situation I can think of where low-reactance speaker cables could be of some tangible benefit is a very large commercial or public address sound system. Even in this case, the length of the speaker cables would have to be quite long.

While on this subject, speaker output jacks are often gold plated to reduce corrosion problems. If your speaker jacks (i.e., speaker connectors) are clean, going to the expense of gold-plated jacks will not improve your sound. (Recently, I read a report suggesting that speaker cables are somehow “directional.” In other words, this person was suggesting that a conductive wire will pass current better in one direction than another. Anyone who believe this nonsense has serious problems with rudimentary comprehension of basic electricity!)

8. In the practical sense, class A amplifier designs do not sound better than class B designs. There is no question that test results of a well-designed class A power amplifier will be superior to those of a class B design when comparing the results of analytical test equipment (i.e., distortion analyzers, spectrum analyzers, etc.). The important thing is that the differences are not perceivable to the human ear. Several of the amplifier designs in this book can approach the noise floor in THD measurements. Based on known human hearing sensitivity, this means modern class B designs are capable of sonic accuracy literally hundreds of times lower than what can be humanly perceived. When comparing the enormous differences in price and efficiency between class A and class B designs, there simply isn’t any “practical” reason to consider class A.

Note: Some audiophiles want a class A system for the reason that the sonic accuracy is “as good as it gets.” I don’t have any criticism of this attitude, and the option is certainly open to anyone who wants to

“know it’s there” even if it doesn’t have any practical application. Many of my efforts in the audio field are directed toward excellence in areas that I already know to be lower than human perception. After all, most sports car enthusiasts want to own a car that can go four times faster than they can legally or consciously drive. There aren’t any real limits to the extremes anyone should go to in the enjoyment and appreciation of their hobby. The goal of this book is not to dissuade a serious audio enthusiast from any methods; however, it should be understood that an audio enthusiast on a limited budget can also obtain excellent results.

Being Realistic toward Present and Future Trends

It is apparent that there is much misinformation in the audio field, especially in the area of audio power amplifiers and associated equipment. The audiophile phenomenon has been around long enough to develop some pretty strong mainstream indoctrination, so I expect to continue to see the same old myths and heresies for a considerable time. The good news is that the serious audiophile does not have to succumb to it, and the health of our ears and wallets can all benefit from accurate information. I sincerely hope this book can provide some help in this area.

For a long time now, there has been a myth circulating within the general populace and unassociated electronic professionals that the lowly audio power amplifier was perfected long ago. Nothing could be further from the truth. In fact, the areas of acoustic science and audio electronics may be the least legitimately researched fields in the realm of modern science. I believe the proof of this fact lies in the very existence of subjectivism, which I do not believe would have had a chance to grow in the first place if adequate scientific research had been directed toward these fields since the 1970s.

It is a known fact that there is a very strong psychological tie between sound and the emotional state of the human mind. Every true music lover will verify this fact, but I am referring to an even stronger relationship that medical science has only begun to research. At present, the connection between sound and the emotions is a complete mystery. It is quite possible that certain types of acoustic therapy might eventually be effective at treating various medical conditions

such as chronic pain, depression, and drug addiction. Hopeful breakthroughs in this area might spawn exciting new fields of audio technology and associated equipment.

I doubt if the near future will see any great breakthroughs in the areas of class A design, class B design, high-fidelity-quality hybrid design, or integrated circuit audio amplifier design. We have nearly reached the point of beating our heads against the brick wall of the laws of physics in these areas. However, there are areas of major improvement and utilization of class D, class H, and class G architectures, along with significant room for improvements in speaker systems and smart power supplies.

Some additional research into audio engineering and acoustic science will, it is hoped, be motivated by the growing field of virtual reality since sound will make up a large part of any virtual world. I was too young to attend Woodstock when it actually happened, but who knows? Some day, in the not-so-distant future, I may be able to attend “Virtual Woodstock!” What an experience!!

This page intentionally left blank.

Basics of Audio Power Amplifiers

Safety Considerations

I have always been a “nag” about electrical safety. I suppose that’s one reason that I am still around to nag. As I stated earlier, this book is not the place to learn basic electronics, and I have assumed that the reader is already knowledgeable and experienced in this area. Likewise, along with the reader’s technical expertise, I have assumed the reader to be experienced in the fundamental safety procedures associated with the electronics field. It is unfortunate that I cannot do justice to these areas within the space constraints of this book.

Electrical safety is a paramount issue. If you are reading this book with intentions of constructing any of the projects in it, please do not begin if you are a novice in electrical safety. Find a good book on the subject, study it, and memorize it. I have no doubt that a good working knowledge of electrical safety has saved my life over the course of many past industrial engineering projects.

Keeping with the primary theme of this book, there are a few areas of electrical safety that are somewhat unique to power amplifier design, so I would like to touch on those subjects.

To those of you who have been working with computers and logic levels for the last 10 years, I would like to remind you that the AC line voltage and high VA-rated power transformers are nasty items to get into a confrontation with. The large coffee-cup-size filter capacitors used in amplifier power supplies can store high-voltage charges for weeks and cause screwdrivers, pieces of wire, or a variety of conductive items to literally blow up in your face. In rare cases, the capacitors themselves can blow up if they are wired incorrectly or excessively leaky. Play it safe and use eye protection when working with these capacitors or other high-current areas of power amplifiers.

If you happen to be involved with any commercial sales or servicing of audio power amplifiers, research the requirements of your applicable safety and emission regulations. It amazes me how some of my peers seem to be so complacent when it comes to product liability. If someone is harmed as a result of an avoidable piece of poor workmanship, the person who did the work is justifiably responsible. Remember that high-power audio amplifiers are intended to be placed into “large systems,” some of which represent many thousands of watts of electrical power. The overall electrical safety of such a system is only as good as the most dangerous piece of equipment involved. This may sound overdramatic, but high-powered audio amplifiers are not to be taken lightly. In addition, one serious lawsuit is all it will probably take to put you seriously out of business. Why risk it?

As a final safety comment, please don't take your ears for granted! It is a pity that so many people each year must revert to hearing aids due to nerve deafness because they listened to music chronically at excessively loud volume levels. If you often hear a ringing in your ears after listening to your stereo, your listening level is too high and you are damaging your ears! Turn it down a little. After all, being an audio enthusiast becomes pretty dull if you can't hear!

Input Requirements

Audio power amplifiers are well standardized to operate from line-level voltage signals. Virtually all audio power amplifiers are designed to reach full-power output from a line-level input voltage of 1 volt RMS or less. For any specific amplifier, the required input voltage for a specified output power is referred to as the amplifier's *input sensi-*

tivity. All of the amplifier designs in this book have an input sensitivity of about 0.7 to 0.8 volts RMS.

The input impedance of commercial and home-built audio power amplifiers can vary quite drastically. Typical values are anywhere from 100 k Ω to as low as 5 k Ω . Although there isn't a commercial agreement on a specific value of input impedance, there are a couple of ambiguous "standards" that aid in determining some best-fit values. It is typically assumed that the *external source resistance* (i.e., the output impedance of the device outputting the line-level voltage to the power amp) is 50 ohms. However, it is quite common in the real world for this figure to be much higher. To accommodate bridging applications, the standard input impedance of power amplifiers is required to be at least 10 k Ω .

It might be suspected that a power amplifier with an input impedance of 100 k Ω would be susceptible to an excessive level of stray noise picked up from input cables or electrical fields. But in real-world testing, the low (it is hoped) external source impedance combined with only rudimentary-quality shielded input cables seems to minimize any problems in this area. I have used numerous public address amplifiers with 100-k Ω input impedances for live stage performances without any problems. (Typically, a live stage performance is a worst-case scenario for an audio power amplifier.) The ultimate cure for noise problems in professional audio is, of course, the utilization of balanced inputs. However, there appear to be minimal problems associated with using standard high-impedance cables between the output of a mixing console and the inputs to various power amplifiers, provided that the length of the run is not excessive.

Input impedance does play a significant factor in the noise specification of an audio power amplifier (primarily due to the contribution of Johnson noise at the input stage). For the best possible noise performance, the input impedance should be as low as is practically feasible. Again, this means going to balanced inputs or standardizing at about 10 k Ω for general-purpose applications. A 10-k Ω input impedance is an excellent compromise for domestic hi-fi applications. Another

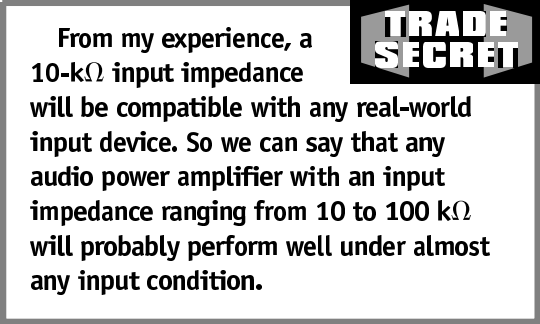

From my experience, a 10-k Ω input impedance will be compatible with any real-world input device. So we can say that any audio power amplifier with an input impedance ranging from 10 to 100 k Ω will probably perform well under almost any input condition.

option would be to bootstrap the input stage, but the realistic noise specification improvement for this additional modification does not justify the trouble, in my opinion.

If an input level (i.e., volume) control is going to be installed on the input stage of an audio power amplifier, it is desirable for the amplifier's input impedance to be about 20 k Ω or higher. The "tap-to-high quality ground connections" of the level control potentiometer will be placed in parallel with the amplifier's input, thus reducing the overall input impedance to a minimum of 10 k Ω if the potentiometer's resistance is matched to the amplifier's input impedance. The installation of input level controls on power amplifiers intended for domestic hi-fi applications is optional; for professional public address applications, it is a necessity.

Load Considerations

Audio power amplifiers are universally tested using 4- and 8-ohm resistive loads. This is not surprising considering that virtually all speaker systems are specified as being either 4 or 8 ohms. In reality, however, all speaker systems are "reactive" to some degree, and the true impedance curve of a loudspeaker system (including the internal crossover network) can be as individual as a fingerprint. Depending on the crossover network, speaker enclosure design, and the response of the individual speakers (i.e., drivers) themselves, an 8-ohm speaker system impedance can vary from about 5 ohms to over 40 ohms as we sweep through the audio bandwidth (that is, 20 Hz to 20 kHz).

Since such extremes of speaker impedance variation occur during normal operation, many audiophiles have argued that amplifier testing utilizing 4- or 8-ohm power resistors does not reflect a true test of a power amplifier's performance when driving an actual speaker system. They are right! But in response to this objection, the question must arise, "What, then, do we use for comparative analysis?" To date, the audio industry has not developed any form of standard speaker to facilitate such real-world testing. It is feasible to develop a family of speaker models for thorough testing of a power amplifier model in software simulation (some of this type of analysis has already been accomplished with impressive results). However, software simulation

has its limitations, and there are audio power amplifier variables that cannot be plugged into a simulation engine.

Years ago, when electrostatic speakers became popular within some esoteric audio circles, the input capacitance to the driver electronics was roughly estimated to be about 2 μF . Many audiophiles considered this condition to be a worst-case baseline of reactive loading, so a tradition developed of testing audio power amplifiers with an 8-ohm resistive load paralleled with a 2- μF capacitor. The validity of this test could be disputed since the reactive effect of the capacitor becomes relevant only about midway through the audio spectrum, but you may still see it used occasionally.

At present, the use of resistive loads for comparative analysis seems to be the only available method. In reality, resistive testing is not as inadequate as it is alleged to be by many critics. In my experience, any audio power amplifier demonstrating good stability and distortion characteristics when loaded with 4- and 8-ohm resistive loads will almost certainly perform admirably into any real-world speaker load.

Audio power amplifier performance improves when driving 12- or 16-ohm speaker loads (that is, THD levels will decrease). This is a reasonable expectation since the load demands are reduced as seen by the power amplifier and the effect of beta droop is less prominent.

From a performance perspective, 2-ohm loads should be avoided whenever possible. There are a variety of reasons for this. First, the beta-droop effect (i.e., large-signal nonlinearity) seen in a BJT output stage will increase quite dramatically with 2-ohm loads, causing substantial increases in the THD. Second, the overall efficiency of the power amplifier drops, due to losses in speaker cables, source or emitter resistors, PC board tracks, and beta droop. Third, the significant rise in output current is more damaging to output relay contacts (if used). Fourth, the increased power output is more demanding on the output devices and

TRADE SECRET

For as long as I can remember, there has been a myth that the power output capability of an audio power amplifier will double when changed from an 8- to a 4-ohm load. This relationship does not hold true due to the increased losses encountered during 4-ohm operation and the physics involved in actual power development. Typically, an amplifier delivering 100 watts RMS into an 8-ohm load may provide 160 watts into a 4-ohm load, or 210 watts into a 2-ohm load (if it can drive a 2-ohm load). The actual performance comparisons of a variety of power amplifiers will vary widely in this regard, with primary dependence on the variations of power supply design.

heatsinks, which can cause thermal protection circuits to trip or (worst case) output devices to fail. Fifth, chronic use of 2-ohm loads will almost certainly place the output devices in a lower section of their associated thermal cyclic curve, decreasing the predictable reliability of the power amplifier.

In addition to the previously listed problems with 2-ohm loads, the reactive nature of a 2-ohm speaker load will always cause impedance dips at certain frequencies (like any other speaker load). These dips will approach a 1-ohm point, causing most short-circuit protection circuits to activate, reducing the maximum output current. Short-circuit activation will cause the same nasty sound as clipping and present the same danger of damaging sensitive speaker system tweeters if the condition is prominent and chronic.

All of the power amplifier projects in this book will drive 2-ohm loads in a stable manner *if* the value of the emitter or source resistors is reduced to modify the action of the short-circuit protection circuits. The details of this modification will be explained in the associated discussions of the individual amplifier projects. However, as stated previously, I recommend avoiding 2-ohm loads if at all possible, for

the simple reason that we are approaching the “hairy edge” of functional practicality.

QUICK TIP

There is an old myth stating that audio power amplifiers should never be tested without connecting them to an appropriate load. In the case of solid-state power amplifiers, this concept is not only false, but it can be destructive if initially testing a newly constructed amplifier. Most certainly, this belief evolved from some very early solid-state designs incorporating output transformers. If you should happen to run across an old solid-state amplifier utilizing a transformer in the output stage, don't test it without a load (personally, I wouldn't even bother testing it—I'd simply scrap it for parts). In addition, many vacuum tube amplifiers should not be tested without an appropriate load.

Frequency Response

It should be no surprise that the frequency bandwidth of an audio power amplifier is designed to accommodate the frequency bandwidth of the human ear. Normally, this is considered to be 20 Hz to 20 kHz. In reality, human ear sensitivity is not flat across this frequency spectrum (i.e., the ear is more sensitive to certain frequencies than others), and few people, if any, can actually hear frequencies at the designated extremes. As a further complication, the ear's sensitivity to certain frequencies will vary according to the sound pressure level (SPL). For example, at medium SPLs and

midrange frequencies, an approximate ten-fold increase in the output wattage of an audio power amplifier will produce a doubling of loudness to the ear. However, regarding bass frequencies, only a five-fold increase in output power may be needed to accomplish the same result. Therefore, the subjective loudness level to the ear of a variety of sounds (measured in *phons*) is actually dependent upon three variables—SPL, frequency, and bandwidth perception—and these three variables are nonlinear, interactive, and highly individualistic. In simple language, an analysis of human acoustic perception is a mess!

Note: Back in the 1950s, these complex relationships were charted by the United Kingdom’s National Physical Laboratory. They are referred to as “The Robinson & Dadson Free-Field Equal-Loudness Contours.”

Luckily, in building audio power amplifiers, we do not have to worry about how the human ear actually perceives sound—we simply have to reproduce it. On the surface, this would seem to be a simple matter of ensuring a flat frequency response of 20 Hz to 20 kHz, covering all extremes of human hearing. Unfortunately, this situation, like most situations in life, is not quite as simple as we would like it to be.

Complex music contains myriad high- and low-frequency harmonics, many of which are beyond human hearing. The problem is that if we remove these imperceptible harmonics, we are left with a void that must be filled. If this void is filled with something we *can* hear, the original sound has been colored. In other words, an amplifier with a high-frequency bandwidth of only 20 kHz is likely to slew-distort a 30-kHz transient into something perceptible, depending on a variety of conditions. (This phenomenon is commonly called *slew-induced distortion*, abbreviated SID.) Consequently, a high-quality audio power amplifier will have a frequency bandwidth considerably greater than normal human hearing.

Technically speaking, the frequency bandwidth of an audio power amplifier is defined by its upper and lower ± 3 -dB limits. In reference to modern solid-state, direct coupled amplifiers, there should never be any “plus” involved, or you have a serious instability problem. Fortunately, with modern complementary output devices, we have little trouble achieving very wide bandwidths.

The upper, or high-frequency, limitation is primarily a matter of compensation. Typically, for hi-fi audio applications, this limit will be anywhere from 60 to 100 kHz. Attempting to extend the upper-frequency response to extreme measures is asking for trouble from a stability perspective, and useless from a performance perspective. All things considered, I like the upper-frequency response to come out somewhere between 80 and 200 kHz in my designs.

The low-end, or bass, response of an audio power amplifier presents a different set of problems. With modern designs, the signal path is DC coupled from the beginning to the end of the power amplifier circuitry, and the only typical capacitor in the actual signal path is the input coupling capacitor. Therefore, the low-frequency response is essentially determined by the RC time constant of the amplifier's input impedance (erroneously considered R for the sake of calculation) and the value of the input coupling capacitor. Since modern compact discs have a flat-frequency response down to DC, it becomes very tempting to simply remove the input coupling capacitor and fully utilize the extraordinary low-frequency capability of compact disc.

DC coupling for CD playback has received a lot of hype in the consumer marketplace and a number of audio publications. Unfortunately, DC input coupling must be considered a fad rather than a practical method of improvement. First of all, if subsonic (sometimes called *infrabass*) information exists on the compact disc, no domestic speaker will reproduce it. Second, if a speaker could reproduce it, we could not hear it. Third, if it is argued that we could “feel” it, the feeling of vibrations is applicable only down to about 5 Hz—anything lower incites seasickness!

Besides its impracticality, DC coupling can also cause some unnecessary problems. At very low frequencies, DC speaker protection circuits begin to become active, causing useless thumps, pops, and interruptions in the program material. Also, constant subsonic content robs both amplifier and speaker systems of substantial power that could be utilized to produce discernible sound. This wasted power can heat speaker coils and overdrive speaker cones in low-frequency drivers, causing distortion and reduced reliability. In sum, there isn't anything to be gained from and a lot to lose with DC input coupling.

Several of the amplifier designs in this book have a low-frequency response down to 3 Hz. I incorporated extreme low frequency response

into these designs to please some of the hard-core esoterics who want to have it so they can know it's there. To go any lower than this is pointless, bothersome, and potentially destructive.

Distortion

Harmonic distortion is defined as any distortion, or coloration, caused by the artificial generation of harmonics. For the purposes of discussion throughout this book, *harmonic distortion* will always be assumed to be associated with subtle nonlinearities rather than profound types of distortion, such as clipping.

Distortion has already been touched upon in Chapter 2 in the context of disentangling some erroneous concepts of the subjectivist perspective. Further discussion is provided later in this book to explain distortion mechanisms or specific circuits designed to reduce harmonic distortion.

Modern digital audio techniques (as utilized by DAT and CD sound mediums) provide line-level signals with less than 0.002 percent THD. When considering the entire audio distortion chain (i.e., the various stages from recording to playback that can interject distortion), we can almost forget about distortion originating from a high-quality sound medium—it simply won't be there. Relative to audio power amplifiers, I consider it a shame to ruin such remarkable fidelity with a power amplifier injecting a hundredfold increase in distortion. The old proverb that “a chain is only as strong as its weakest link” is certainly applicable. My philosophy is simply that audio power amplifiers should be as distortion free as possible, without severely compromising the performance of any other parameters.

A realistic and practical attitude demands that we remember that there is still one link left in the audio chain following the power amplifier—namely, the speaker system(s). At what point does audio power amplifier distortion become negligible when swamped with the distortion characteristics of the speaker system? I wish I had a good answer for this question, and I hope the future holds some serious and scientific research efforts in this area. At present, we can establish some good baselines for realistic power amplifier goals based on limits of human perceptibility, thus adopting the attitude that our associated speaker systems will be “ideal.”

QUICK TIP

If reasonable construction methods and quality materials are utilized in building the high-quality projects offered in this book, it is reasonable to expect to achieve THD performance in the order of two to five times better than human perception. I believe this to be an excellent compromise, considering that further improvements in THD performance would require additional expense, complexity, and compromise to statistical reliability.

As stated in Chapter 2, it is a proven fact that the human ear can perceive high-order harmonic distortion as low as 0.3 percent. If we assume that our rule-of-thumb calculation of upper-bandwidth harmonic distortion (i.e., around 20 kHz) is going to be a multiple of 10 times the standard 1-kHz measurement, that sets our maximum 1-kHz distortion performance goal at approximately 0.03 percent.

Beyond this consideration, pushing THD performance down into the “noise floor” can not possibly improve any kind

of practical amplifier performance characteristics, whether they be imagined or measured.

Damping Factor

In short, my advice to the audio enthusiast regarding the damping factor of any solid-state audio power amplifier is simply, “Don’t worry about it.” The role of an amplifier’s damping factor has been traditionally misrepresented and misconceived. I hope this section will shed some perceptual light on the subject.

Damping factor (DF) is defined as the ratio of the load impedance (Z_{load}) to the power amplifier output impedance (Z_{out}):

$$DF = \frac{Z_{\text{load}}}{Z_{\text{out}}}$$

The ideal audio power amplifier would appear to be a perfect voltage source to the speaker system being driven by it. In other words, just as in the case of a well-designed regulated DC power supply, the output impedance of an ideal audio power amplifier will approach zero, meaning that an infinite variety of load variations will have little effect on the voltage level output of the power amplifier. Audio power amplifiers are designed to be as close to a perfect voltage source as possible, thus reducing the effect of dynamic load variations inherent to all typical speaker systems. Referring to the previous DF equation, if a perfect power amplifier with zero out-

put impedance could be constructed, the damping factor would become infinite.

It is desirable to have the damping factor as high as possible for a variety of reasons. From a performance perspective, the higher the damping factor, the less affected the power amplifier becomes to load variations. A side effect of a high damping factor is the reduction of resonance problems in speaker systems. From a sales and promotional perspective, manufacturers want the DF to be as high as possible to make a good competitive showing in the numbers game. The pertinent question to the audiophile in this context is, “How high does the damping factor have to be for excellence in audio quality?”

The high level of negative feedback utilized in solid-state amplifier design coupled with the high quality of modern output devices easily provides amplifier output impedances lower than 0.1 ohm. The output impedances of the amplifier projects provided in this book will range from about 0.04 to 0.02 ohm. A round-about average of 0.04 ohm for most solid-state designs and a speaker load of 8 ohms will provide us with a typical solid-state damping factor of approximately 200. As we have already discussed, the typical 8-ohm reactive speaker load will dynamically vary under normal use; consequently, the damping factor will also vary in direct proportion.

The output configuration of a power amplifier and load can be simplified, substituting hypothetical resistors in place of impedance values, as illustrated in Figure 3.1. There are three variables in the simplified output circuit: the output impedance of the power amplifier (Z_{out}), the impedance of the speaker cables (Z_s), and the nominal impedance of the speaker system (Z_{sp}). For discussion's sake, consider the resistor equivalents to be 0.04 ohm, 0.1 ohm, and 7 ohms, respectively (these are very reasonable real-world values). In this equivalent circuit, the damping factor comes out to 175, the total circuit resistance is 7.14 ohms, and the output impedance of the power amplifier counts for only 0.56 percent of the total resistance. If we decrease the amplifier output impedance by a factor of 10, bringing it down to 0.004 ohm, the damping factor rises to a whopping 1750, and its total influence on the output configuration changes to 0.056 percent. It should be readily apparent from this example that a damping factor increase of over 1500 resulted in only a 0.5 percent change in the amplifier's

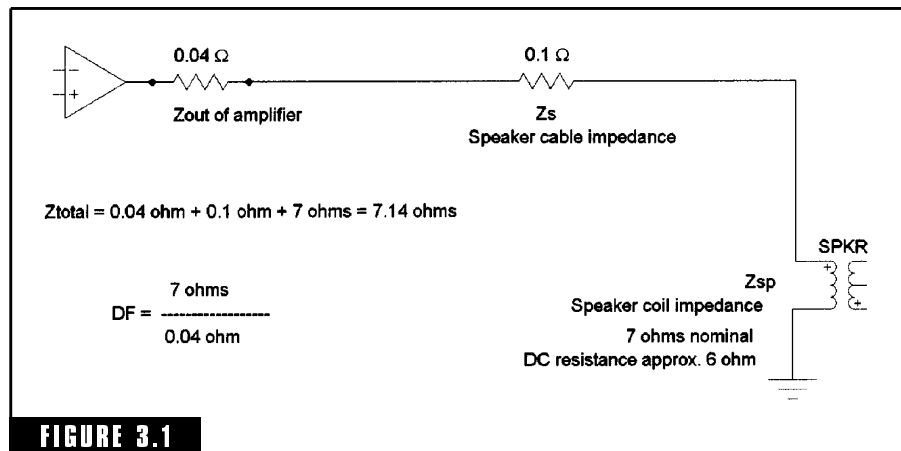

Simplified diagram of a typical audio power amplifier output circuit, including speaker.

contribution to the dynamics of the speaker system. A change of such minute proportion cannot possibly be perceived.

Many articles have been written throughout the years suggesting the mental image of an audio amplifier with a high damping factor rigidly grasping the cone of a loudspeaker and forcing it to respond purely on the basis of the amplifier's electrical output. This simply cannot be realistic. Assuming the reactive component of a speaker system could somehow be negated, it will always be left with the DC resistance of the speaker coil. Since a typical 8-ohm speaker has a DC resistance of at least 6 ohms, an amplifier's output impedance would have to be in excess of 0.66 ohm to affect speaker dynamics by more than 10 percent. Such an amplifier would be extremely poor by solid-state standards.

The bottom line of this discussion is simple: The subjective difference between two amplifiers, one specified with a DF of 150 and another boasting a DF of 1500, is not going to be perceived by human hearing. Due to the high global negative-feedback characteristics of solid-state amplifiers, output impedance will virtually always be so low that the DF should not be of any practical concern. This is the reason I began this discussion with the comment "Don't worry about it."

Noise

Noise is often used as a general catch-all term to describe any unwanted sound emanating from a speaker system. The full list of

distortion parameters and/or mechanisms (i.e., harmonic distortion, crossover distortion, intermodulation distortion, clipping distortion, etc.) is sometimes erroneously lumped together under the classification of noise. In the casual sense, noise also encompasses a host of intermittent pops, crackles, buzzes, thumps, and fizzles. (I hate fizzles. Often, when you hear a fizzle, the power amplifier that fizzled never makes any noise again!)

As the term *noise* is defined relative to professional audio and the context of this book, it is the random generation of complex electrical signals resultant from the physics of electronic component operation. In more practical and simpler language, noise is generated in the input stage of audio power amplifiers and consists primarily of *recombinational noise* (generated from active devices) and *Johnson noise* (generated from passive devices, primarily resistors).

If you connect an audio power amplifier to an appropriate speaker system, short the input connection, and turn the volume all the way up (0 dBr), the annoying hiss you hear from the speaker is what is technically classified as noise. If you hear a low-frequency roar at about 60 or 120 Hz, you are listening to hum, and you have a definite problem in your power amplifier. Modern power amplifiers should never exhibit hum levels higher than noise levels. Hum is typically considered part of the noise spectra in the evaluation testing of most audio power amplifiers.

The most common term defining noise characteristics of audio power amplifiers is the *signal-to-noise ratio* (abbreviated SNR or S/N), expressed in RMS value averaged across the audio range and designated in negative decibel levels relative to 0 dBr (i.e., the reference full-output level of the audio power amplifier). Normally, the amplifier input is shorted for noise measurements. If the noise is measured and averaged without the aid of any specialized audio filtering, the noise specification is said to be “unweighted.” If filters are incorporated to limit the noise bandwidth during evaluation testing, the noise specification is said to be “weighted,” with a designating letter to define the type of filter used (*A weighting*, for example, is probably the most common). The rationale for weighting a noise specification is relevant to the spectra of the noise being generated—the argument presented that it is irrelevant to measure noise signals that are beyond human hearing capabilities. For the most part, the use of filters for

**TRADE
SECRET**

While a little off the subject, I consider it amusing that many audiophiles will spend an enormous amount of money for a “low-noise, high-power” audio amplifier, never utilizing $1/10$ of its maximum power capabilities and completely ruining its low-noise characteristics with fan noise needed to cool the heatsinks for the power capability that isn’t needed. Is that an exercise in circular extravagance or what?

noise evaluation is a conjectural method used by some manufacturers to make their product specifications look better in sales brochures.

In the not-too-distant past, noise specifications of -70 or -80 dB were considered excellent. I still do not vary too far from that opinion at present. In fact, I consider several classic designs of the past to sound great, and I am confident that their noise specifications are not better than -80 dB. The design architectures of the projects in this book facilitate the construction of

amplifiers with S/N specifications of -90 dB or better (one design measured out at less than -110 dB). More will be discussed concerning noise reduction techniques in Chapter 4.

Power Output and Efficiency

The relationship between audio amplifier power output (measured in watts RMS), subjective loudness (measured in sones), sound pressure level (measured in decibels), and frequency (measured in hertz) is a “hairy animal” to discuss, define, or perceive. In fact, there are several areas of this complex interrelationship that are not agreed upon by psychoacousticians or audiophiles. Therefore, I will not clutter this discussion with poor illustrations or nebulous definitions that would turn out to be singularly useless to begin with. Let us suffice with the following brief concepts.

As a rule of thumb, most audiophiles assume that output power must be quadrupled to double the sound pressure level (that is, a $+6$ dB increase). This has been a long-held tradition. The doubling of subjective loudness, on the other hand, may require a substantially greater increase than $+6$ dB, and it is frequency dependent. In terms of power output, this means an audio power amplifier may have to produce a tenfold increase in power to double the subjective loudness at certain frequencies. The main point to this discussion is that a 60-watt RMS audio power amplifier is not going to provide a practical loudness any greater than a 50-watt RMS amplifier, and significant increases in sub-

jective loudness are going to require massive increases of amplifier output power capabilities.

Back in the mid-1970s, there was a tremendous amount of hype relating to the maximum “reserve power” required for accurate reproduction of high-level transients. As a means of introducing their high-quality, 400-watt RMS audio power amplifier kit, the Heathkit Company suggested that the maximum reserve power needed for excellent audio reproduction should be from 5 to 10 times the power utilized at normal listening levels. For example, if you normally listen to your stereo system at a level of 20 watts per channel, you would need a power amplifier rated at 200 watts per channel to reproduce the high-level transients accurately. This suggestion was accompanied with some impressive charts illustrating the peak levels of transients as compared to the nominal audio levels. Of course, these charts were based on output power levels and, as we have just discussed, this correlates poorly with actual subjective loudness results.

The trend toward higher power output levels of the early 1970s was soon countermanded by the subjectivist movement in the late 1970s toward vacuum tube amplifiers. Suddenly, reserve power and accurate high-level transient reproduction were seldom mentioned because it is difficult and very expensive to coax high output power from vacuum tube amplifiers.

I believe there is sufficient scientific, subjective, and experiential support for a reasonable amount of reserve power to accommodate acoustic transients. I would not go as far as the Heathkit Company did in the 1970s, but I believe a two- to threefold reserve power capability is reasonable. This is especially true for CD playback, since CDs offer an enormously wide dynamic range capability (i.e., about 120 dB).

For domestic hi-fi applications, it would seem that 100 watts RMS per channel is more than sufficient for almost any audiophile (possibly 200 watts if you have a large home and like to listen to really loud music). Efficient speakers are actually of greater significance than the audio power amplifier, since high-end speaker system efficiency can vary by a ratio of 10 to 1. This is another way of saying that a low-efficiency speaker system can make a 150-watt amplifier sound like a 15-watt amplifier, comparatively speaking.

The audio amplifier builder should be cognizant of the fact that there are significant cost *break points* when deciding on the output power desired. Due to degradation of reliability factors, I do not recommend trying to coax more than 100 watts RMS from an output stage incorporating only a single pair of output devices (my own rule is to go to paralleled outputs at the 80-watt break point). There are also significant break points in power transformer design, with transformer pricing seeming to rise exponentially with VA ratings. Consequently, it is very possible to face a situation wherein the cost of a 100-watt amplifier can come out to about 50 cents per watt and jump to 80 cents per watt if you decide to increase your project to 125 watts. In this illustration, the cost of the amplifier project doubled for the additional 25 watts, and it is doubtful that subjective listening tests could even detect a difference.

Power efficiency in a complete audio system (including the speaker systems) is a depressing subject, no matter how you look at it. The *overall efficiency* of an audio power amplifier is determined by two variables: the efficiency of the power supply unit (PSU) and the amplifier output stage (OPS). Overall efficiency is calculated by the following equation:

$$\text{Percent overall efficiency} = \text{percent OPS}_{\text{eff}} \times \text{percent PSU}_{\text{eff}}$$

This equation tells us that if the efficiency of the amplifier output stage is 74 percent and the power supply efficiency is 70 percent, the overall efficiency of the power amplifier is 49 percent. In fact, a 70 percent efficiency rating for both power supply and output stage is very typical for a solid-state class B amplifier. Theoretically speaking, the efficiency of a class B stage can approach 78.5 percent, but in real-world situations, 70 percent is about tops.

Some newer power supply designs, such as *chopper* or *switching designs*, can achieve higher efficiencies than typical linear *raw* DC power supplies. This is especially true of the newer generation of *smart power supplies*, incorporating automatic *power factor correction*. However, for the most part, their utilization has been motivated by reduced weight and space requirements (there are some serious drawbacks also).

The highest theoretical efficiency of a push-pull class A amplifier output stage is 50 percent. Again, in real life, it comes closer to 40 per-

cent. The overall efficiency of a class A amplifier utilizing a PSU with a 70 percent efficiency rating comes out to about 28 percent. (Most audiophiles follow a general rule of thumb of assuming a 25 percent overall efficiency rating for push-pull class A designs.) Consequently, a 200-watt class A amplifier design would have to be capable of dissipating about 600 watts of wasted heat energy on a continuous basis (there aren't many 200-watt class A amplifiers around).

Class G and class H amplifier architectures have boasted of overall efficiencies above 80 percent, but the most commercially successful of this category, Carver, Inc., claims a modest 65.7 percent. Class D amplifiers routinely claim efficiencies of well over 90 percent, but significant problems relating to EMI and RFI emissions, coupled with difficulty obtaining a high degree of sonic accuracy at higher frequencies, has limited the use of class D systems to commercial applications.

Regarding vacuum tube audio power amplifiers, the overall efficiency is extremely low, considering that the majority of wasted power is dissipated in the heater filaments. I haven't been able to find a typical efficiency rating to provide a ballpark estimation of what to reasonably expect from tube designs. However, I think it is significant that dogs like to lay in front of them on cold winter nights, thinking they are fireplaces.

All audio amplifier designs incorporating MOSFETs as output devices will show a slight decrease in efficiency due to the higher "on" drain-to-source impedance as compared to the "on" collector-to-emitter impedance of a standard BJT. In respect to the use of MOSFETs for high-power applications, this small disadvantage is greatly outweighed by several other advantages in high-power situations. More will be discussed on this later.

In the beginning of this discussion, I declared that efficiency in audio systems is a depressing matter. While the previously discussed overall efficiency statistics of audio power amplifiers are not exceedingly terrible, the typical efficiency of most direct radiating speakers varies from only 1 percent to as low as 0.05 percent! By plugging in a few real-world numbers, we can readily see how bad this situation truly is. Suppose we start with 1 kW of continuous usage of electrical energy from an AC source. At the typical overall efficiency of a class B amplifier, the amplifier could convert this energy consumption to 490 watts of continuous electrical output power to a speaker load. If we

split the difference between speaker system efficiency extremes, assuming a speaker efficiency of 0.5 percent, the 490 watts of amplifier output power is converted to only 2.45 “acoustic” watts of power delivered to the air. In other words, our complete audio chain is less than $\frac{1}{4}$ of 1 percent efficient!

While it is exciting to think of improved technological breakthroughs in the areas of class G, H, and D architectures, improvements in speaker system efficiencies would have a much greater practical impact upon the audio industry.

Phase Considerations

The terms *phase distortion* and *absolute phase* have been bandied about in the audio industry for a long time. *Phase distortion* applies to phase variations between the program material and the output signal of a power amplifier (or any other audio device). In the case of any audio power amplifier design, phase distortion could not possibly exceed 360 degrees because at about that point the amplifier would become a “delay line” and global negative feedback would be quite impossible. It has never been proven that phase distortion is audible, even in extreme situations. The only area of concern in this regard should probably be targeted toward surround-sound applications, and this aspect would pertain only to the quality of 3-D effects, not the actual sonic quality of the program material. I am not even sure how such a test would be performed or how the results would be defined.

As stated previously, the reactance of the output transformer automatically places vacuum tube amplifiers in the category of being the most susceptible to extreme phase variations. Even if phase distortion is not audible under any circumstances, there are still derogatory connotations associated with it from the marketing perspective.

The term *absolute phase* is typically used to define an *in-phase condition* in opposition to an *out-of-phase condition*. In other words, if an amplifier is in absolute phase with the program material, it is a noninverting amplifier. Again, there is no evidence to suggest that out-of-phase program material will sound differently from in-phase material (in fact, how would it be known if the program material was recorded in an in-phase or out-of-phase condition?).

With solid-state power amplifiers incorporating the typical Lin three-stage architecture, the amplifier will always be noninverting and will exhibit minimal phase shifting (depending on compensation and input coupling variations). In sum, my advice is to forget about absolute phase and phase distortion; it's going to be as good as it gets without even trying.

Reliability Considerations

Reliability considerations can be divided into two groups: *statistical reliability* and *predictable reliability*. The overall reliability of any power amplifier is a product of these two variables.

Many people believe the myth that solid-state devices have infinite life spans. In small-signal and low-power applications, this opinion is reasonably true. In the case of semiconductor power devices, however, nothing could be further from the truth. As the materials in a power semiconductor device are heated, they will expand and/or physically distort, similar to the way a bimetallic strip will bend when heated. The heat expansion of the device will not be uniform because all semiconductor power devices are constructed of dissimilar materials (i.e., aluminum housings, silicon junction layer, copper connections, etc.). Even though temperature distortions are extremely small, they will lead to material fatigue in a predictable fashion. Semiconductor manufacturers' specifications for the *mean time between failure* (MTBF) rate as a function of power dissipation (heat energy) and thermal cycles are called *thermal cyclic curves*. In simple terms, these curves predict the expected time of a semiconductor failure based on the maximum power it has to dissipate and the number of times it cycles from full-power to zero-power dissipation.

A *thermal cycle* is a transition from cold to hot (don't confuse thermal cycles with signal cycles). For example, if I turned on a power amplifier that was totally cool, operated it until the heatsinks and power devices reached their maximum temperature, and then turned



There have been outrageous claims made in some subjectivist circles that phase distortion creates a sort of “out-of-time” effect during music playback. This is completely false because the amplifier would have to literally become a delay line to cause such an effect. Since it is scientifically, physically, and electrically impossible for the components used in any kind of power amplifier to delay an audio signal for more than a percentage of a single cycle, we can place this concept in the category of audible metal, directional speaker cables, and predicting the future with monkey entrails.

it off, I would have put it through 1 thermal cycle. The effect of a thermal cycling can be demonstrated with an ordinary incandescent light bulb. If you take a new incandescent light bulb and continuously turn it on and off, it will last only a short time. Each time it is turned on and off, the metal filament expands and contracts, which causes physical stress. Pretty soon, as in the case of bending any piece of metal back and forth, the filament will break. A thermal cycle has the same effect on a power transistor.

As any thermal cyclic chart will indicate, the MTBF of power semiconductors will increase by logarithmic proportions as the maximum power dissipation is decreased in a linear fashion. For example, a thermal cyclic chart for a hypothetical transistor may indicate that at a 100-watt dissipation level, the expected MTBF will be about 1000 cycles. However, the same curve may indicate that at a 50-watt dissipation level, the MTBF will rise to 100,000 cycles. Therefore, it becomes apparent how predictable reliability can be improved dramatically by lowering the required dissipation of power semiconductor devices.

Based on thermal cyclic curves, many audio designers have developed the mistaken idea that the same type of reliability improvements can be had by adding larger heatsinks or going to some form of forced-air cooling. In reality, these methods help to some degree, but the concept is wrong. The destructive thermal distortion occurs internally within semiconductor devices, in the area of the semiconductor junction. Heatsinks and other external cooling methods are effective at reducing excessive heat buildup, but they are limited in their ability to reduce semiconductor junction temperatures. About the only effective method of decreasing internal junction temperatures is to decrease the device's dissipation.

Audio power amplifier manufacturers, caught in the bind between cost and performance competition, will try to squeeze every watt possible from a single complementary BJT pair. This design attitude results in substantial compromises with predictable reliability characteristics. However, if the thermal cyclic curves indicate that the output devices will last past the warranty period, the amplifier is often marketed. (*Note:* This is one of the major drawbacks of “encapsulated hybrid amplifier modules.” Due to size, space, and cost restrictions, hybrid modules never incorporate more than two output devices. Thus, their long-term

reliability record has been poor.) Reliability consideration is a major reason why many audiophiles like to build their own audio power amplifiers. Not only is it possible to save oodles of money throughout the majority of construction, but a few dollars of the savings can be reinvested back into an additional output transistor stage and send predictable reliability through the roof! A competent and experienced builder can reliably construct audio power amplifiers of much higher quality and reliability than commercially available units.

Statistical reliability relates to the statistical chance of failure based on the total number of electronic components incorporated into critical operations. Simply stated, every device is prone to failure. The more devices incorporated into a circuit, the greater the statistical chance will be for a component failure.

Long-term component failure (component failure after a considerable time of circuit operation) may result from several stresses, such as internal corrosion, internal or external contamination, physical stress, thermal cyclic failure (in power devices), destructive voltage or current transients, and secondary thermal failure (heating from another device in close proximity). Sometimes, it appears that a component failed for no good reason. In some of these cases, the component may have been manufactured in a slightly substandard or weakened condition, causing it to fail as a matter of inevitability. Regardless of the causes, the addition of every component to a circuit design increases its chances of failure.

If we took the quest for sonic accuracy to the extreme, designing an audio power amplifier with 0.00001 percent THD incorporating 200 transistors, the statistical reliability would be much lower than an amplifier exhibiting 0.005 percent THD requiring the use of 20 transistors. This is an obvious matter of common sense. Again, as in other areas of design parameters, statistical reliability requires us to take a compromising approach to building the best possible audio power amplifier.

Much of the esoteric audio society has an unfounded contempt for incorporating short-circuit protection methods into audio power amplifiers. However, a good short-circuit protection system will not degrade the sonic quality of an audio power amplifier, and refusing to use one is simply asking for serious reliability problems. Even if you can boast with complete confidence that you never make a mistake when wrestling with a dozen audio cables, allow me to remind you that speaker cables still break, kids still get into things, dogs still chew

QUICK TIP

As a final thought in discussing reliability, it is prudent to construct an audio power amplifier with some forethought as to the consequences if you should experience certain types of component failures. After all, it would be highly undesirable to have the failure of a 59 cent transistor cause a successive failure resulting in the destruction of \$40 worth of output transistors (this is commonly called the *domino effect*).

on tasty looking wire, and spouses still suck up cables with a vacuum cleaner. I rest my case.

Fundamental Audio Power Amplifier Architectures

Audio power amplifiers are not designed by throwing a bunch of transistors together in some haphazard fashion. There are several architectural patterns, or *topologies*, that are adhered to. Much experimentation and research has gone into the develop-

ment of the best type of audio amplifier topology, and this is, without question, the three-stage topology developed by Mr. Lin of RCA back in 1956.

But taking things in order, let us first observe the two-stage architecture of Figure 3.2. I'm not going to elaborate on this design topology

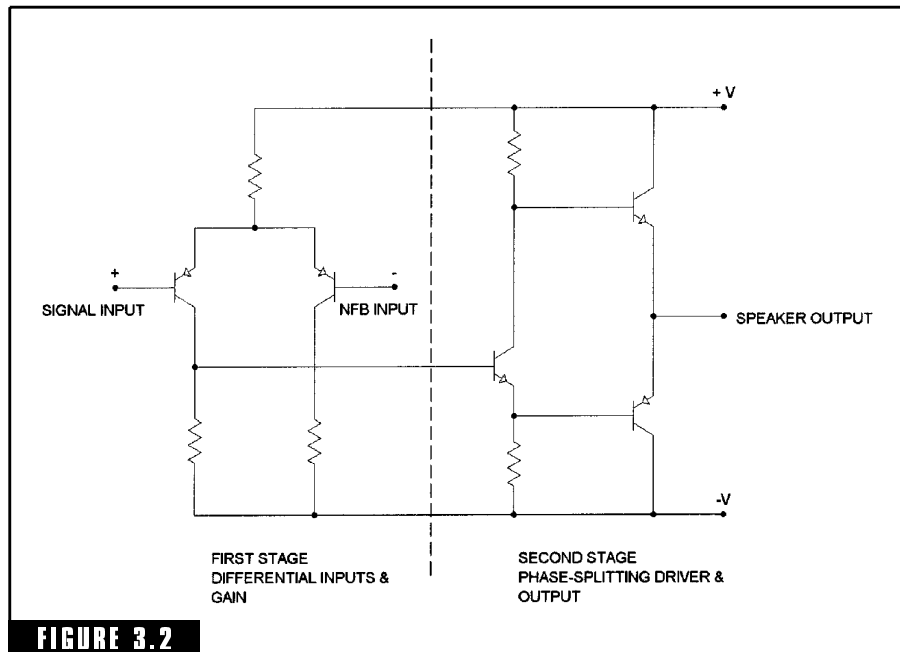

Simplified diagram of a two-stage audio power amplifier design.

to any great degree because it is seldom used. While appearing to have the advantage of using fewer parts, it is difficult to design for real-world stability and virtually always provides inferior performance compared to three-stage designs.

The simplified diagram of a two-stage amplifier in Figure 3.2 illustrates how the first stage, or input stage, must double as both a current and voltage amplifier. The amplified signal from the input stage is fed to a predriver, phase-splitting transistor driving the complementary output stage. The theory is simple, but getting the compensation and gain factors to harmonize into dependable stability is difficult. You won't see many, if any, two-stage designs in the real world.

Figure 3.3 illustrates a simplified diagram of the elegant and popular Lin three-stage topology. A major advantage of this design philosophy is that it allows us to isolate the singular function of each stage and therefore to control the exact performance of various audio amplifier parameters. The Lin three-stage topology makes up over 99 percent of all solid-state power amplifiers constructed, and I feel pretty secure in stating that the remaining small percentage do not fit

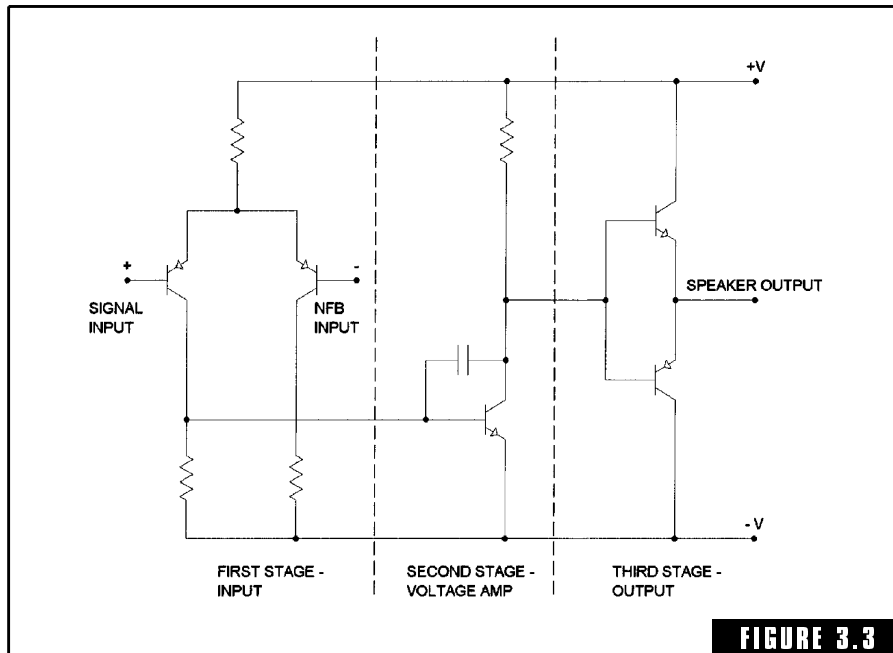

FIGURE 3.3

Simplified diagram of a three-stage audio power amplifier.

into the category of what most would consider high-quality hi-fi. Therefore, this entire book will be devoted to the three-stage foundation of amplifier design and construction, which appears to be the only practical option.

The first stage of Figure 3.3 is a *transconductance* (voltage-to-current) *amplifier*. It buffers the input signal and amplifies it into a proportional current signal applied to the low-impedance input of the second stage. First-stage amplifiers are virtually always differential amplifiers, due to the convenience of having an inverting input for negative-feedback application and the high *power supply rejection ratio* (PSRR) offered by differential designs. The first stage is commonly called the *input stage*.

The second stage of Figure 3.3 is a *transimpedance* (current-to-voltage) *amplifier*. It receives the current signal from the input stage and converts it to a high-level voltage signal, providing the gain compensation response that is so critical to optimum stability. As a matter of convention, the second stage automatically contains a high local negative-feedback factor, and this advantage greatly increases signal linearity (negative-feedback terminology will be discussed in the following section). The second stage is commonly referred to as the *voltage amplifier stage* (VA or VAS).

The third stage illustrated in Figure 3.3 is a *current amplifier*. It receives the high-voltage signal from the VA stage and provides a near-unity voltage gain, high-current output to the speaker load. In function, the third stage is nothing more than a bidirectional common-collector amplifier, but there are a variety of ways in which it can be configured. It is commonly referred to as the *output stage* (OP or OPS).

Negative-Feedback Terminology

Although I have assumed that the reader is familiar with feedback theory and the typical conventions thereof (i.e., negative feedback, degenerative feedback, frequency poles, etc.), there are a few terms relating to negative-feedback schemes that seem to be somewhat unpopular except in audio power amplifier and operational amplifier design circles. Thus this section will provide a brief overview of those terms.

Figure 3.4 provides a self-explanatory illustration of negative-feedback (NFB) methodology as applied to audio power amplifiers. Note that the previously discussed three-stage amplifier architecture is symbolized by three operational amplifiers, labeled A1 (input stage), A2 (VA stage), and A3 (OPS).

As shown in the upper diagram, *local NFB* is NFB applied within a single stage. In this case, feedback from the output of A1 is applied back to the input of A1.

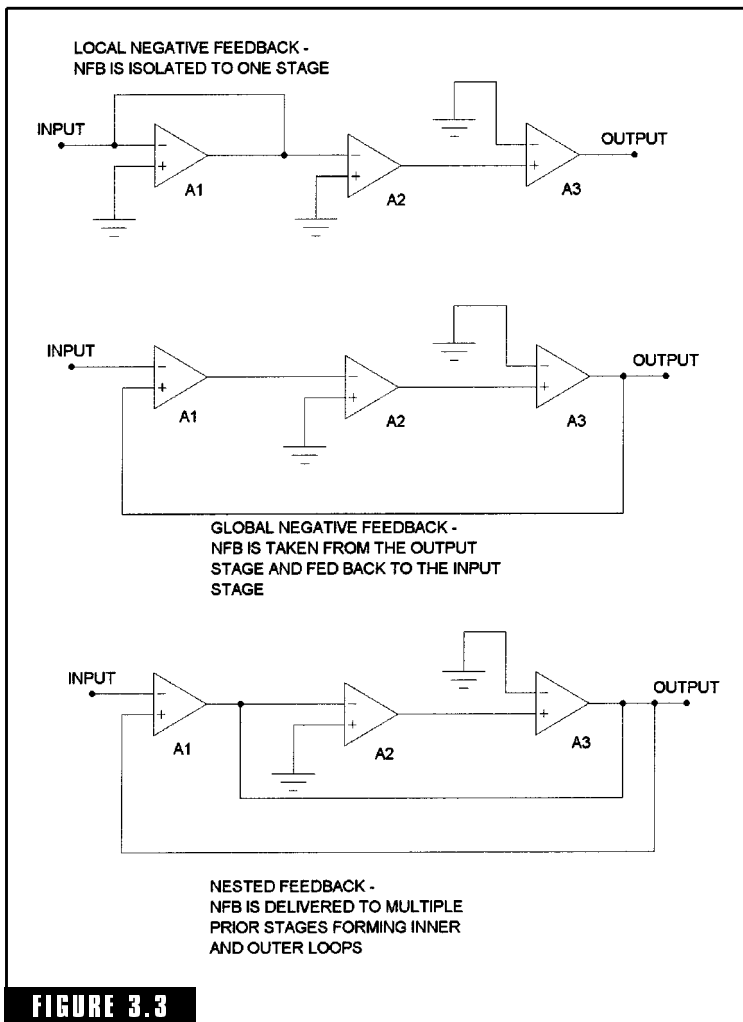

Methods of applying negative feedback (NFB) and associated nomenclature.

The middle diagram illustrates the technique of applying *global negative feedback*. Global NFB is accomplished by taking a percentage of the output stage signal and returning it to the input stage. Large quantities of global NFB are utilized in all solid-state audio power amplifiers.

Finally, the bottom diagram illustrates the technique of taking a percentage of the output stage signal and applying it back to multiple stages, forming multiple NFB loops. This technique is called *nested feedback*. In the illustration, two feedback loops are shown: One is from the output of A3 to the input of A2, and the other is from the output of A3 to the input of A1. Nested-feedback techniques are not incorporated into the majority of audio power amplifier designs.

Input Stage Configurations and Analysis

Functions of the Input Stage

An *input stage* is the first stage of the signal path in an audio power amplifier. Its primary function is to convert a line-level signal voltage from a preceding device into an amplified current signal, which is then coupled to the voltage amplifier stage. In addition to its action as a *transconductance* (i.e., voltage-to-current) *amplifier*, there are several other critical areas of input stage performance. It must act as a good buffer to the input signal, it should exhibit a high immunity to power supply variations (defined by its *power supply rejection ratio*, or PSRR), its linearity should be as high as possible, and its noise generation should be as low as possible (the input stage will essentially determine the SNR specification for the power amplifier).

To accommodate the multidimensional characteristics of high-quality input stages, a variety of common electronic building blocks can be incorporated for optimum performance. It is important to understand the subtleties and limitations of these building blocks to appreciate the idiosyncrasies involved in input stage operation.

Constant Current Sources

The humble *constant current source* is a major gameplayer in almost any audio amplifier design, especially when it comes to input stages. Constant current sources are commonly used to supply the “tail current” in differential stages, improving the stability, speed, gain, and common mode rejection characteristics. Constant current sources have the unique advantage of appearing to be a “high-impedance active resistor,” making them ideal as collector loads for single stage transistor voltage amplifiers.

Figure 4.1 illustrates a pseudo-constant current source. In reality, this circuit is a relatively high value resistor paralleled with a regulated voltage source, but it is often incorporated into input stage

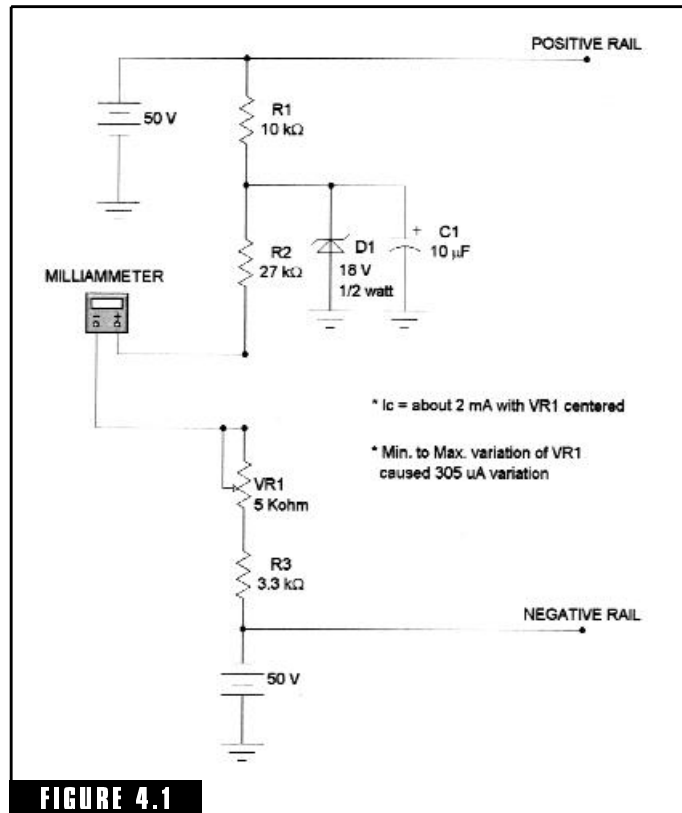
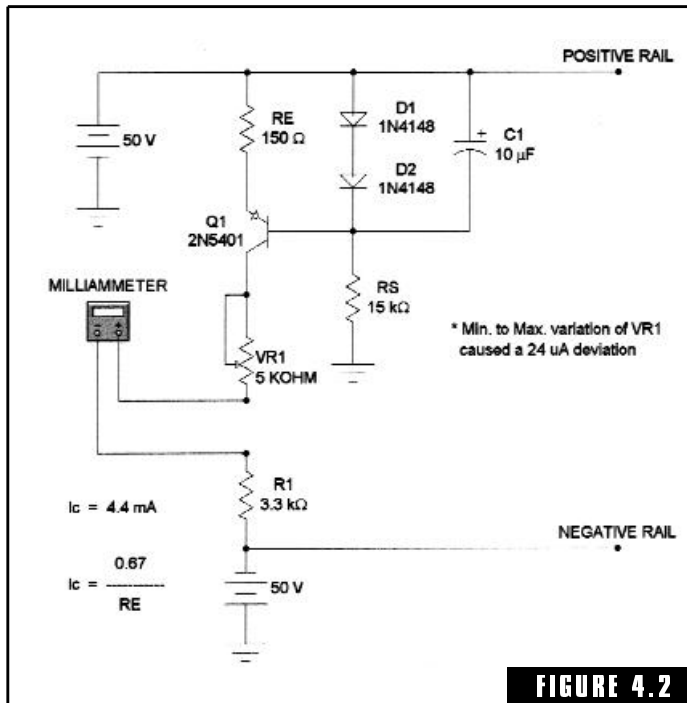

FIGURE 4.1 Pseudo-constant current source, relying on zener voltage regulation.

design as though it were a true constant current source. R1 and D1 make up a simple zener voltage regulator with C1 used to smooth out load and power supply variations. R2 simulates the current source internal resistance.

In Figure 4.1, the pseudo-constant current source is connected between two power supply rails (+50 VDC and -50 VDC) and placed under a variable load, made up of VR1 and R3. With VR1 centered, the current flow through R2, representing the “output” of the constant current source, is about 2 mA. By adjusting VR1 to its minimum and maximum extremes, the output of the constant current source will vary by about 305 μ A. The performance of such a constant current source is far from ideal, but it is considered adequate for some input designs.

Figure 4.2 illustrates a more common form of constant current source incorporating two forward-biased series diodes D1 and D2 as the voltage regulating elements. D1 and D2 are supplied with forward



Common transistor-diode constant current source, relying on forward-biased diode voltage as the regulating element.

current flow through resistor R_S . The voltage drop across D_1 and D_2 , approximately 1.34 volts, is applied to the base of Q_1 and filtered by C_1 . The V_{be} drop of Q_1 essentially negates the forward voltage drop of one of the diodes, causing approximately 0.67 volt to be applied across R_E . The 150-ohm resistance of R_E , in conjunction with the 0.67 volt dropped across it, forces the emitter current to remain constant at about 4.4 mA. Consequently, the collector current of Q_1 is also held at approximately 4.4 mA to the regulation limits imposed by the beta value of Q_1 .

As illustrated, the same load test is applied to this constant current source as was used to test the circuit of Figure 4.1. With maximum to minimum variations of V_{R1} , a total deviation of only 24 μA is observed. Comparing the operation of the current source of Figure 4.1 with the current source of Figure 4.2, it is obvious that the design of Figure 4.2 provides current regulation over 12.7 times superior to that of Figure 4.1. In addition, the internal impedance characteristic of forward-biased diodes is typically less than zener diodes (operating in the zener region), improving the constant current source's immunity to signal and power supply variations.

Continuing to refer to Figure 4.2, the resistance value of R_E can be altered to provide almost any desired current, with a minimum practical value of about 50 ohms (where the R_E/I_c relationship becomes nonlinear). R_E can also be replaced with a potentiometer (connected as a rheostat) if a variable constant current source is desired. Although the constant current source of Figure 4.2 is designed to utilize the forward voltage drop of two diodes, the same design technique is often used incorporating additional forward-biased diodes, LEDs, or zener diodes as the voltage regulating elements. Almost any type of BJT can be used for Q_1 , provided that the circuit conditions do not exceed the transistor parameters.

Figure 4.3 represents a different approach to constructing a constant current source, incorporating transistors Q_1 and Q_2 , resistors R_E , R_B , R_{C1} , and R_{C2} , and smoothing capacitor C_1 . When operational power is first applied, current flow begins through R_{C2} , R_{C1} , the forward-biased base-emitter junction of Q_1 , and R_E to the positive rail source. When the current flow through R_E creates a voltage drop sufficient to turn on Q_2 (about 0.67 volt), Q_2 begins to conduct collector current through R_{C2} and R_{C1} . Q_2 's collector current begins

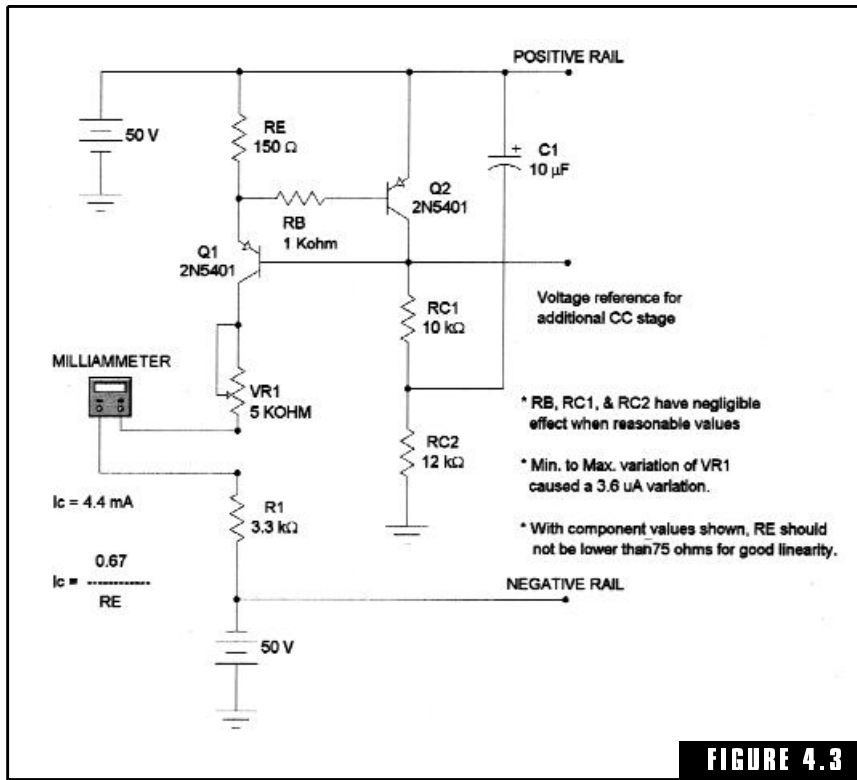
FIGURE 4.3

Dual transistor constant current source, relying on transistor V_{be} characteristics as the regulating element.

to “steal” current flow away from Q1’s base in proportion to the voltage drop across RE. If the voltage across RE tries to increase, the increased base drive to Q2 steals more current away from Q1’s base, holding RE’s voltage constant. If the reverse occurs and RE’s voltage tries to drop, the decreased drive to Q2’s base provides more base drive to Q1. Again, the voltage across RE is held constant. In effect, the voltage drop across RE is firmly regulated to be approximately equal to the V_{be} of Q2. The voltage drop across RB can be considered negligible for all practical purposes.

The constant current source of Figure 4.3 is a much better design than the ones observed in Figures 4.1 and 4.2. The dual transistor action greatly reduces the slight variations in voltage regulation inherent with forward-biased diodes or zener diodes. Immunity to signal or rail voltage variations is very high.

As illustrated in Figure 4.3, the same test circuit that was used in Figures 4.1 and 4.2 is used to test this current source for the purpose of comparative analysis. A minimum to maximum variation of VR1 causes only a minimum to maximum current deviation of $3.6\ \mu\text{A}$. This is over six times better than the current source of Figure 4.2 and about 84 times better than the current source of Figure 4.1.

From a design perspective, the component values for the current source of Figure 4.3 are easy to determine. The rail voltage divided by the total resistance of RC1 and RC2 should come out to a current flow that is roughly half of the desired current flow output of the constant current source. The calculation for RE is the same as described for the circuit of Figure 4.2. The value of RB is noncritical and can remain at around $1\ \text{k}\Omega$ for almost any input stage design application. The practical values of the smoothing capacitor C1 can range from 2.2 to around $47\ \mu\text{F}$. Connecting the bottom of C1 between RC1 and RC2 helps to keep Q1 and Q2 immune to ground rail variations. Also note that Q2's collector can be used as a voltage reference for an additional constant current source stage.

Figure 4.4 illustrates how a JFET can be used to construct an active constant current source. When operational power is applied, current begins to flow through the JFET and the source resistor RS to the positive rail. Since the gate is connected directly to the positive rail, the voltage drop across RS will make the source more negative to the gate in proportion to the RS voltage drop. Stabilization will occur when the positive gate voltage limits the FET channel current to maintain a regulated voltage across the RS.

This current source has the advantages of convention and simplicity, but its regulation is poor compared to other current source designs. The same variables used to test the previous current source circuits produced a total current deviation of $99\ \mu\text{A}$. In addition, the RS/Id relationship is disappointingly nonlinear. The design of this circuit is a kind of hit or miss ordeal since JFET parameters vary widely compared to BJT devices. In many commercial amplifiers incorporating this type of current source, RS will be substituted with a potentiometer (technically, a rheostat) to compensate for JFET variables.

In review of the typical constant current source designs of Figures 4.1 through 4.4, it is obvious that the dual transistor design of Figure 4.3 comes nearest to a perfect constant current source. It may

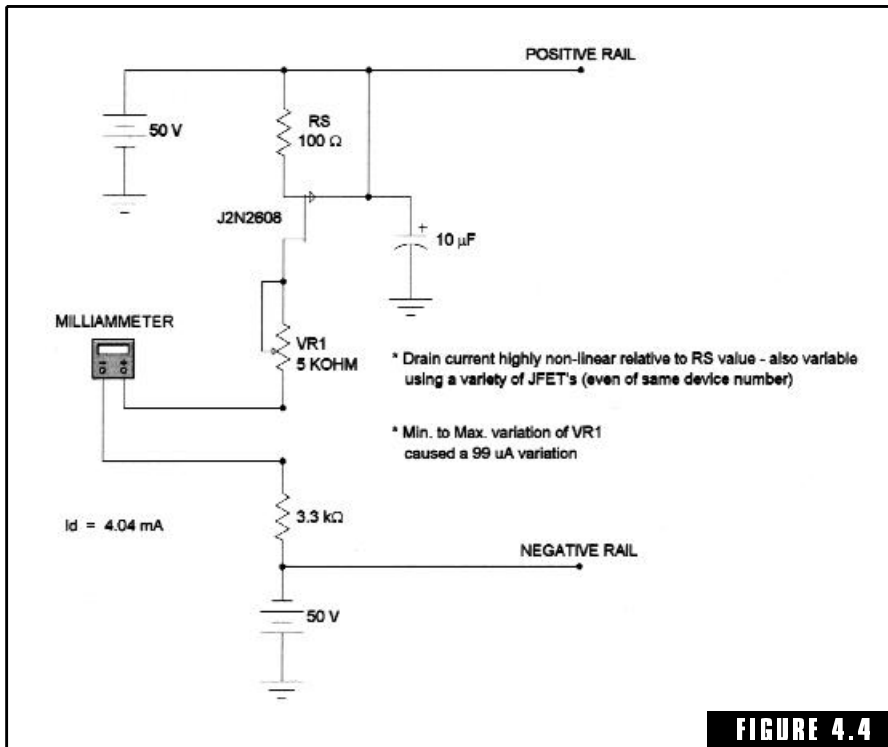

FIGURE 4.4
 JFET constant current source, utilizing current flow through R_S as a stabilizing gate bias.

be argued, however, that the high-performance technique of Figure 4.3 does not provide any practical input stage improvement over the current source technique of Figure 4.2. As we shall see in upcoming discussions involving load variations and slew rate, that argument is about half correct.

Current Mirrors

In my opinion, the use of *current mirror techniques* in audio amplifier design has traditionally received much less publicity than it justifiably deserves. In short, the advantages are extraordinary. The incorporation of a current mirror stage as the collector load for a differential amplifier creates significant improvements in linearity and virtually doubles the amplifier's output current capability and slew rate. If utilized wisely, a current mirror can also provide effective isolation from the

negative power supply rail (or positive power supply rail, depending on the design approach), improving the overall PSRR. As if all of the previous advantages weren't enough, current mirrors also make input stage design a breeze.

Figure 4.5 illustrates a current mirror, consisting of Q1, Q2, RE1, and RE2. A simple test circuit has also been included to provide an idea of the effectiveness of a current mirror. If VR1 is adjusted to its maximum resistance value and operational power is applied, about 2 mA of current will flow through the *test leg* (i.e., the leg with VR1 in it) of the circuit. As VR1 is adjusted down to 1.5 k Ω (changing the total test leg resistance from 10 to 6.5 k Ω), the current through the test leg will hold rock solid at about 2 mA. Without the action of the current mirror (assuming the constant current source is "ideal"), the test leg current should have varied from 1.6 to about 2.03 mA. However, the

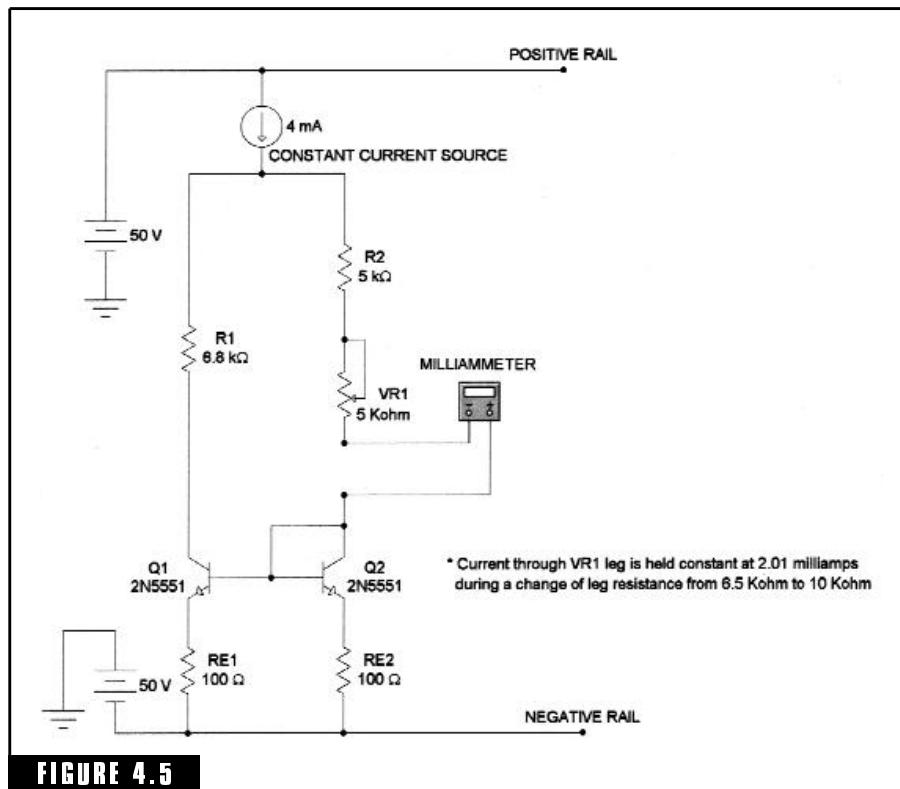

Test circuit used to illustrate the action of a current mirror circuit.

important aspect of the operation of a current mirror is *not* the current regulating effect but the fact that the current from the constant current source is split evenly between the two current mirror legs (i.e., the 4 mA from the current source is evenly divided into 2 mA of current flow through each leg). In other words, a current mirror balances the current flow through two electrically unbalanced current paths.

It is not a well-known or well-published fact that a current imbalance within a differential amplifier will cause a significant increase in nonlinearity. Naturally, increasing nonlinearity results in proportional increases in harmonic distortion, so it is very important to keep differential stages in a quiescent balanced state for minimal distortion characteristics. Experience has taught me that many electronics personnel seem to have some difficulty understanding the physics involved in this phenomenon; the following parable may clarify this relationship.

When I was attending grade school, there was a deluxe version seesaw in our playground (I have always associated the action of a differential amplifier with seesaw physics). The reason I classified our seesaw as a “deluxe version” is that it had an adjustable fulcrum, or “pivot” point. The purpose of the adjustable pivot was to offset the lever action, allowing a heavy child and a light child to balance each other out. However, if two children of the same approximate weight tried to use the seesaw with the pivot point displaced from the center of the seesaw, one child would become the dominant weight and exert nonproportional control over the other child’s weight.

The same basic concept is applicable to differential amplifier physics. One reason for the high inherent linearity of a differential amplifier is the balancing effect of the nonlinearities of one transistor with the nonlinearities of the other. Since the transistors are functioning in an opposing, or inverting, mode to each other, the nonlinearities of one transistor tend to cancel (or balance out) the nonlinearities of the other. Thus, linearity is excellent. But if the differential amplifier becomes unbalanced, one transistor’s nonlinearities will become dominant over the nonlinearities of the other, and a significant rise of nonlinearity from the dominant transistor will result. For optimum linearity performance, the current balance of a differential amplifier should be held to within 1 percent of perfection.

A current mirror performs the task of differential balance admirably. If the two current mirror transistors are of the same type,

beta-matched to within 10 percent of each other and properly degenerated, the differential balance can be held easily to within 0.1 percent.

The operation of a current mirror circuit is relatively simple. Referring again to Figure 4.5, imagine RE1 and RE2 are not in the circuit and the emitters of Q1 and Q2 are tied directly to the negative rail. Connecting the collector of Q2 to the base of Q2 forces forward current flow through the base-emitter junction of Q2. Since the base-emitter junction of Q1 is connected in parallel with the base-emitter junction of Q2, Q1 is forced to “imitate” the forward conduction of Q2. If the V_{be} and beta characteristics of the two transistors happened to be perfectly matched, the current flow through Q1 would have to be an exact match (or mirror image) to the current flow through Q2. Thus, the total circuit current flow coming from the constant current source would be forced to split evenly through the two legs of the current mirror.

Unfortunately, in real life, perfectly matched transistors are hard to come by. Adding some appropriate emitter degeneration resistors to negate the V_{be} differences of Q1 and Q2 solves this problem. Figure 4.5 illustrates these resistors as RE1 and RE2. In reality, the values given to RE1 and RE2 are much higher than they need to be. A good rule of thumb is to calculate these resistance values based on the requirement to drop 50 mV under quiescent conditions. For example, for the circuit conditions illustrated in Figure 4.5, 2 mA of current will flow through each leg. Therefore, the rule-of-thumb resistance value of RE1 or RE2 would be 50 mV divided by 2 mA, or about 25 ohms. Since 25 ohms is not a standard value, a 27-ohm resistance value would do nicely for both RE1 and RE2.

Since a current mirror is placed in the collector legs of a differential amplifier, it also doubles as the collector load. Several other

advantages (besides current balance) are immediately realized. First, the current mirror acts like an active load, so it essentially imitates the action of a dual cascode stage. This effect essentially doubles the current output capability of the differential amplifier, and proportionally increases the slew rate (or half the slew rate.) (Problems with symmetrical slew

QUICK >>> TIP

When we recognize all the advantages to be had from two small-signal transistors, two resistors, and the time it takes to do one simple Ohm's law calculation, we can appreciate the “bargain” of current mirrors. I love current mirrors!!

rates will be discussed later.) The current mirror also provides a type of “isolating” effect between the differential collectors and the power supply rail, increasing the PSRR of the input stage.

Input Stage Fundamentals

An accurate understanding of the ideal input stage requires an understanding of how it works together with the remaining two stages of the three-stage topology.

As I stated earlier, the primary function of the input stage is to accept a line-level input voltage and convert it to an amplified current signal. There are several good reasons for not performing voltage amplification at the input stage, but for now, all of the reasons can be generalized in the simple concept that it facilitates independent control of the most desirable power amplifier characteristics.

Figure 4.6 illustrates a more detailed schematic of a generic three-stage amplifier than provided in Chapter 3. As shown, the line-level input signal is amplified by the input differential amplifier, consisting of Q1, Q2, and the associative circuitry. The output of the differential stage is taken from the collector of Q1 and applied to the base of the VA stage transistor Q5. Note that the input impedance of Q5 is low, which is typical for a *transimpedance amplifier* (i.e., current-to-voltage amplifier). It is desirable for the input impedance of the VA stage to be very low, approaching what is often called a *signal virtual-earth*.

Nearly all the voltage gain for the entire power amplifier occurs in the VA stage. Since the OPS consists of a near-unity voltage gain amplifier, the voltage signal at the collector of Q5 is essentially the same voltage that will be seen at the speaker output (minus a slight voltage loss in the OPS).

Global NFB is applied to the power amplifier by taking a portion of the output signal and feeding it back to the inverting input of the input differential amplifier (i.e., transistor Q2). The output signal from the input stage (i.e., the collector of Q1) is inverted relative to the line-level input signal. The VA stage inverts it again, returning it to a near in-phase condition as it is applied to the OPS. The OPS is a noninverting amplifier, so the NFB signal taken from the OPS is considered to be in-phase when it is applied to the inverting input of the input differential amplifier.

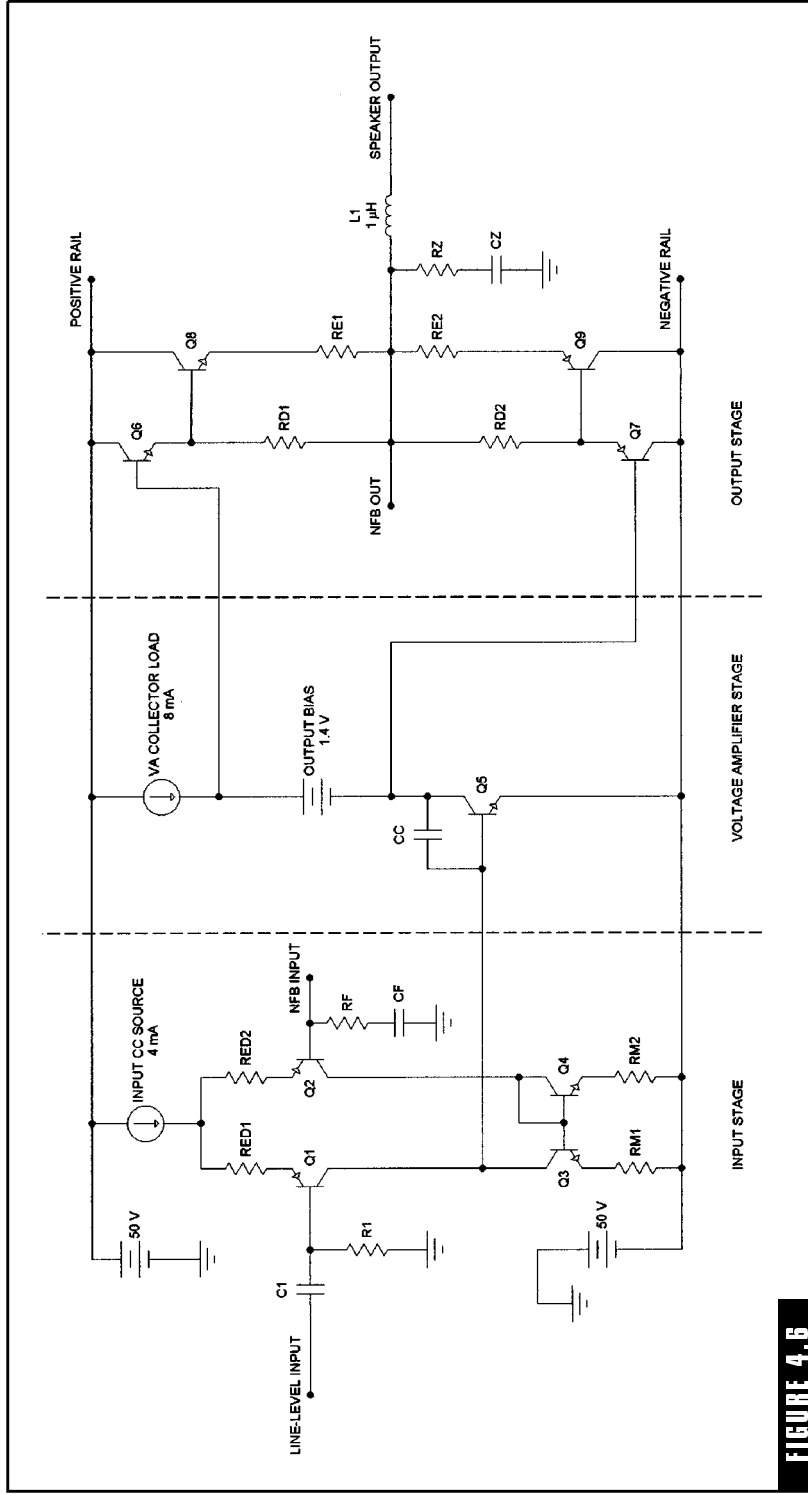

FIGURE 4.6

Simplified schematic of a generic audio power amplifier.

Note: Technically speaking, there will be some phase shift in the NFB signal due to the effects of Miller capacitance and the dominant pole capacitor CC. However, this phase shift will never exceed 90 degrees within the useable bandwidth of the amplifier.

Referring to Figure 4.6, assume the dominant pole capacitor CC is removed from the circuit and the global NFB signal is not applied to the base of Q2. Under these conditions, the low-frequency open-loop voltage gain of the power amplifier is the product of the input stage transconductance and the VA stage transimpedance (voltage gain does not occur in the OPS). This will be a very high gain factor, but it is difficult to predict because about one-third of the calculation depends on the ill-defined parameter of Q5's beta. However, as we shall soon discover, the absolute value of the open-loop voltage gain is rather insignificant, as long as it is a high value.

As with any amplifier circuit, the voltage gain will vary in respect to frequency. Utilizing common operational amplifier terminology, the frequency range wherein the open-loop gain remains fairly constant is called the *low-frequency region*. The region above this, where the gain decreases steadily by a constant 6 dB per octave, is logically referred to as the *high-frequency region*. The breakpoint frequency at which the amplifier crosses over from the low-frequency region to the high-frequency region is called the *dominant pole frequency*, typically abbreviated as P1.

The factor controlling the P1 frequency is the Miller capacitance of the transistor stages. Without the aid of CC, the voltage gain factor interacting with the effect of Miller capacitance at high frequencies will produce a voltage gain and phase shift sufficient to cause sustained oscillation if any practical amount of global NFB is incorporated. Self-sustaining oscillation resulting from excessive phase shift in the NFB loop is colloquially referred to as *Nyquist oscillation*. The correction of phase-shift problems so that stability is achieved is called *Nyquist stability*. The primary function of compensation capacitor CC is to lower the P1 frequency so that the voltage gain drops *below unity* before a phase shift sufficient for inducing oscillation can occur. Good stability is the consequential result. This compensation method is referred to as *Miller dominant-pole compensation*.

The operation of a well-designed three-stage audio amplifier should actually be investigated from two independent perspectives—the frequency region below P1 and the frequency region above P1.

As I stated earlier, a voltage gain in the low-frequency region is a product of the transconductance (gm) of the input stage and the voltage gain (A_e) of the VA stage. Voltage gain of the VA stage is the product of Q5's beta value (B_{VAQ}) and the impedance of its collector load (Z_c). Therefore, the overall voltage gain of the power amplifier at low frequency can be expressed in the following equation:

$$A_{e(\text{power amp})} = gm \times B_{VAQ} \times Z_c$$

In the high-frequency region (above P1), the value of compensation capacitor CC as well as the frequency must be taken into account. Therefore, the high-frequency voltage gain ($A_{e(\text{HF})}$) is calculated from the following equation:

$$A_{e(\text{HF})} = \frac{gm}{2 \times \pi \times \text{frequency} \times CC}$$

Once the gain, compensation, and frequency fundamentals have been established, we can then walk through the audio frequency spectrum and describe the internal operations of the generic amplifier of Figure 4.6. For discussion purposes, assume a nominal value of global NFB is being applied to Q2 and a value of CC has been chosen to cause P1 to be at 300 Hz.

From 20 to 300 Hz, the overall voltage gain is flat and very high. Consequently, the level of global NFB applied to Q2 is also proportionally high, and the speaker output signal is very linear due to the high global NFB factor.

Several interesting things begin to happen as we continue to go up in frequency and pass the P1 point. First, as I stated earlier, the voltage gain begins to drop as the capacitive reactance of CC starts to decrease. A decrease in overall voltage gain means a proportional decrease in global NFB, which should result in a proportional rise in nonlinearity at the output. But it doesn't! As the capacitive reactance of CC decreases, it begins to supply an increasingly significant amount of local NFB to the base of Q5. The increasing local NFB taking place in the VA stage helps to countermand the loss of global linearization. In other words, the effect is a very elegant and stable transition from

global to local NFB as the frequency rises to the upper end of the amplifier's bandwidth.

The greatest disadvantage of losing the high level of global NFB is the loss of control over crossover distortion. Since crossover distortion is a distortion mechanism exclusive to the OPS, the high global NFB enjoyed in the low-frequency region can provide significant reduction of crossover effects. However, the loss of global NFB at higher frequencies results in a proportional loss of linearizing control over crossover distortion. This is one reason that harmonic distortion will rise steadily with an increase in frequency.

Besides the transition from global to local NFB, there are a few more subtle mechanisms taking place as frequency rises in the high-frequency region. Due to the effect of the falling impedance of CC, the input impedance of the VA amplifier (Q5) is also falling. This is both good news and bad news at the same time. The good news is that it makes the Miller capacitance of the input stage appear to decrease and minimizes phase shift. The bad news is that the drive current required by the VA stage doubles with each octave increase, and this situation could easily drive the input stage into nonlinearity of transconductance at very high frequencies. However, if the differential tail current is sufficient and a current mirror is utilized for the differential collector pair load (as illustrated in Figure 4.6), reasonable values of CC should not cause any problems. Inadequate design techniques in this regard are one reason that many commercial amplifiers exhibit such poor high-frequency distortion characteristics.

As the input impedance of the VA stage drops with frequency rise, the output impedance also drops. If the output of the VA stage is properly loaded, this is a good result. Since the output impedance of the VA stage is decreasing because the local NFB factor is increasing, the output signal from the VA stage is improving in linearity. The lower output impedance and improved linearity actually help the OPS with crossover problems resulting from variations in beta values. In addition, the decreasing VA output impedance has the effect of minimizing Miller capacitance in the OPS.

Thus far, we have discovered that both the input impedance and output impedance of the VA stage fall with rising frequency, and this characteristic minimizes the effect of Miller capacitance in both the input stage and OPS. As the Miller effect within the input stage and

OPS falls with frequency increase, the compensation capacitor CC becomes even more dominant than it was at low frequencies. The point is, at higher frequencies, high gain, and high-amplitude voltage swings, where we would normally expect to have fits with internal semiconductor capacitance problems, CC takes over and dominates the high-frequency realm. This technique of minimizing input and output stage capacitance with a middle stage of dominant capacitance is called *pole splitting*.

Pole splitting is a valuable tool for optimum audio power amplifier performance, but it is a difficult animal to tame in a two-stage design. This is one good reason for incorporating a transconductance amplifier for the input stage. Another good reason relates to the physics of operation.

A transconductance amplifier input stage (as illustrated in Figure 4.6) relies on the physics of transistor operation rather than the ambiguous parameter of beta. Degeneration resistors RED1 and RED2 are still incorporated, but their purpose is to linearize (i.e., flatten out) the transconductance curve rather than neutralize the wide variance of beta parameters. For all practical purposes, the input stage transconductance (gm) value of the input stage will depend on the value of tail current and the accuracy of current balance between the two differential transistors Q1 and Q2. Within practical limits, neither beta nor BJT type will play a significant role in transconductance operation.

The equation for determining the transconductance value (gm) for the input stage illustrated in Figure 4.6 is as follows:

$$gm = \frac{\Delta I_{\text{output}}}{\Delta V_{\text{Input (diff)}}$$

The absolute transconductance value of the input stage will be predetermined by the current load demands imposed upon it by the VA stage (the predominant factor being the value of CC; this is discussed further in Chapter 5). The values of gm for some of my amplifier designs have ranged from the extremes of 6.7 to over 28 mA/V, with nominal values around 11 mA/V.

Another advantageous characteristic of a transconductance amplifier is its immunity to output load variations. As explained earlier, the input impedance of the VA stage will decrease by about 6 dB per octave above the P1 frequency. This kind of impedance drop could

have a dramatic effect upon the output linearity of a high-gain voltage amplifier, but it goes virtually unnoticed by a well-designed transconductance amplifier. For an evaluation of this characteristic, I constructed the input stage amplifier shown in Figure 4.6. I deleted capacitors C1 and CF (tying RF to circuit common) and installed typical components and component values for the associated circuitry. The input impedance of the VA stage was simulated with a variety of resistors connected between the collector of Q1 and circuit common. The results were impressive. I could not detect any change in current linearity or quiescent levels with load variances ranging from 10 to 1000 ohms. However, don't expect those kinds of results without a current mirror.

In summary, we have discovered that a transconductance amplifier is chosen for the input stage of a three-stage Lin topology for a variety of reasons. First, it facilitates pole splitting, which is crucial to high-frequency stability and performance. Second, the ill-defined parameter of transistor beta is replaced with the highly predictable action of transistor physics, thus providing dependable, repeatable, and stable operation. And finally, the transconductance linearity can remain highly linear in the face of massive load impedance variations.

Evaluation of Modern Input Stage Designs

I have put much thought into the best way to test and evaluate the performance of the input stage under dynamic operation. Obviously, the input stage cannot function as a stand-alone circuit because its dynamic operation depends on the frequency-dependent global NFB (i.e., above P1) and falling output load impedance presented by the VA stage. One method is to totally isolate the input stage with specialized instrumentation and directly evaluate its parameters and operation. This is not a simple task, but it has been accomplished in a most insightful and ingenious manner by Douglas Self in his book entitled *Audio Power Amplifier Design Handbook*, Newnes Publications, 1996 (ISBN: 0-7506-2788-3). In attempting to be sympathetic to the needs and resources available to the typical audiophile, however, I have elected to approach the problem from a different perspective.

Referring again to Figure 4.6, it has already been established that all voltage gain occurs in the VA stage (i.e., the product of Q5's beta value

and the impedance of Q5's collector load). The output bias circuit incorporated into the VA stage functions as a slight forward bias for linearizing the complementary output stage in the crossover region; thus it has nothing to do with the functions of the input stage or VA stage. Since the global NFB applied to the base of Q2 is a factor of feedback voltage (not current), the entire OPS is also irrelevant to the input stage operation (except for gain losses and crossover distortion linearization, which are mechanisms that must be examined during dynamic operation of a complete three-stage closed-loop amplifier). Remembering that voltage gain or signal inversion does not occur in the OPS, the signal voltage at the collector of Q5 can be thought of as practically identical to the signal voltage present at the output of the OPS. Therefore, the output bias circuit of the VA stage and the entire OPS can be eliminated for input stage testing purposes. In other words, it is possible to construct a baseline VA stage (without any output bias circuitry) and simulate global NFB directly from the collector of Q5.

Figure 4.7(a) illustrates how a baseline VA stage can be utilized to test the dynamic performance of an input stage design. However, you will notice that I made some changes to the simplified VA stage as discussed previously. Since the operation and design variations of the VA stage will be discussed in Chapter 5, I won't go into that here. For now, we will just accept the fact that the baseline VA stage represents a good design that can allow us the luxury of comparing the dynamic performance of various input stage designs with a minimum of interference.

The baseline VA stage consists of C7 (CC capacitor), Q3, Q4, R8, and the 6.7-mA constant current source. The global NFB circuit consists of R5, R6, C5, R7, C6, and D1. In addition, C3 and C4 are power supply decoupling capacitors, C1 and C2 are input coupling capacitors, and R2 is the input leg resistor. For comparative analysis, the VA stage, the global NFB circuit, the decoupling capacitors, input coupling capacitors, and the input leg resistor will be held at their baseline values so that variations of circuit performance will be attributable to variations of input stage performance.

The input stage being tested in Figure 4.7(a) is a simple differential amplifier design. It consists of R1, Q1, Q2, R3, and R4. This design was popular in the 1970s for domestic hi-fi and musical instrument amplifiers. The value of R1 was determined by deciding on a desired tail current and calculating the resistance value to drop the entire positive

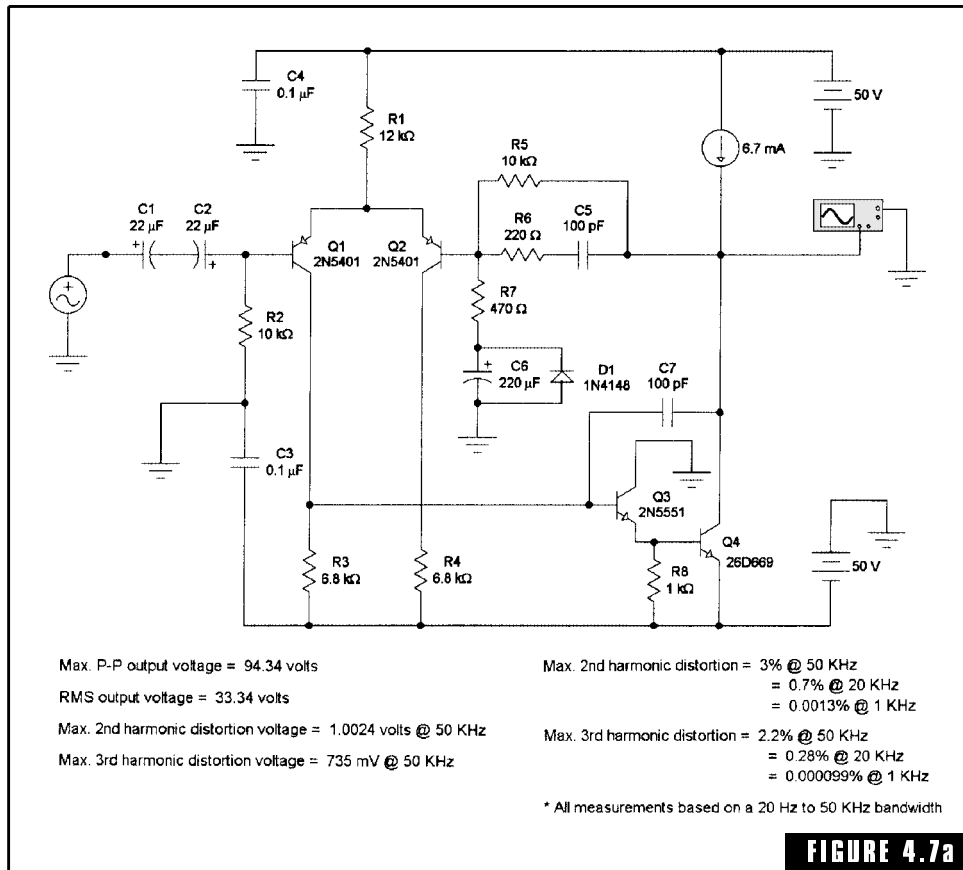
FIGURE 4.7a

Typical input stage design utilizing a differential input transistor pair.

rail voltage. In this case, 50 volts divided by 12 k Ω provides about 4.1 mA of tail current. As a rule of thumb, the collector resistors R3 and R4 were chosen to be about half the value of R1.

The input AC signal source was adjusted to provide about 94 volts peak to peak (P-P) of AC signal voltage on the VA output (i.e., the collector of Q4). Utilizing 50-VDC rail supplies, this represents about the maximum peak-to-peak voltage that can be expected. All measurements were taken at this point, which is represented by a miniature oscilloscope icon.

Referring to the associated performance graph in Figure 4.7(b), the distortion characteristics of the Figure 4.7(a) differential input stage can be observed. The vertical axis of the graph represents distortion voltage

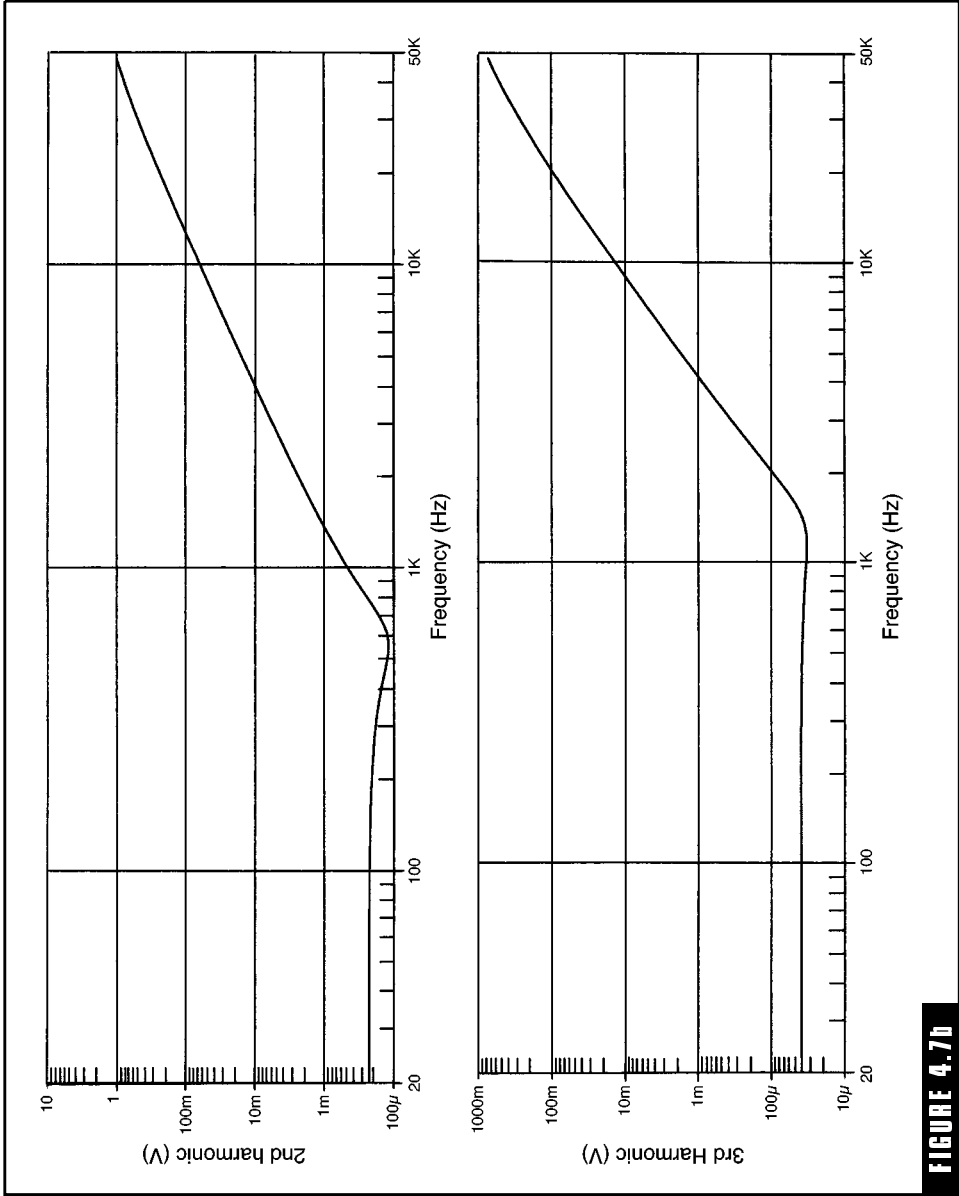

FIGURE 4.7b

Distortion analysis of the Figure 4.7(a) input stage circuit.

(the m and μ stand for millivolts and microvolts, respectively), while the horizontal axis represents fundamental frequency. Note that the upper graph illustrates how the second harmonic distortion content varies with frequency, rising at about 6 dB per octave above the P1 point, which is a little above 500 Hz in this case. The rise in second harmonic distortion above P1 is due primarily to the reduction of gain and the proportional loss of linearizing global NFB.

The lower graph represents the third harmonic distortion content. Third harmonic distortion is more prominently generated from differential input pair imbalance and current starving the input stage as the charging requirements of CC increase with frequency (i.e., as the input impedance to the VA stage drops). The combination of these two factors, imbalance and current starving, causes the slope of the third harmonic curve to rise more steeply than second harmonic generation. Notice also that the significant increase of third harmonic generation begins above 1 kHz in frequency, which is another indication that its primary source is not the loss of linearizing global NFB (which began a little above 500 Hz).

If we summed the content of both the upper and lower graph into a singular curve representing the combined effect of the loss of global NFB, input stage imbalance, and current starving of the input stage, the resultant rise in combined distortion would come out to about 18 dB per octave. It should now be readily apparent why a 1-kHz THD measurement is so inadequate in truthfully representing the sonic performance of an audio power amplifier. Things can look impressive at 1 kHz and deteriorate rapidly before reaching the limits of human hearing.

Going back to the schematic diagram of Figure 4.7(a), consider the ways the input stage could be improved to combat all the problems observed in the distortion performance curves. First, the problem of falling linearity associated with the loss of global NFB can be reduced by placing some linearizing local NFB in the input stage. As I stated previously, input stage gm is a result of transistor physics (not beta), controlled by the tail current and the input pair balance. If the tail current is increased, the gm will proportionally increase (within limits), affording us the luxury of degenerating the input stage with resistors placed in the emitter legs of Q1 and Q2. If the input pair is truly balanced, the gm will improve by an even greater degree.

It should be noted that the input stage of Figure 4.7(a) is *not* balanced, even though it presents a visual imagery of balance by incorporating the two identical collector resistors R3 and R4. From an electrical perspective, the output load placed on Q1's collector automatically forces the differential pair into a state of extreme imbalance, to the point where it would probably perform better if R4 were deleted altogether.

If R3 and R4 were substituted by a well-designed current mirror circuit, three problems could be improved at once. Since a current mirror has the capability of both sinking and sourcing current without the current's having to flow through a collector load, the current-starving problem can be essentially cut in half. A current mirror will also force the differential pair to remain in a state of true balance so that gm increases (allowing us more linearizing degenerative feedback that can be incorporated into the input stage), and the generation of third harmonic distortion resulting from input stage imbalance can almost be eliminated.

Figure 4.8(a) illustrates an input stage with all of the aforementioned improvements incorporated. First, the tail resistor was replaced with an active constant current source consisting of Q3, Q4, R1, R7, R8, R9, and C5. The input transistor pair has been heavily degenerated with resistors R2 and R3. And finally, the differential pair collector resistors have been replaced with a current mirror consisting of Q4, Q5, R5, and R6 (R5 and R6 are degeneration resistors for the current mirror, as explained earlier). All other circuit parameters have remained unchanged.

In comparison to the input stage design of Figure 4.7(a), the input stage of Figure 4.8 shows extraordinary improvement in performance. The distortion graphs in Figure 4.8(b) reveal that the second harmonic distortion content at 50 kHz is 8800 times less than the Figure 4.7(a) circuit! The third harmonic distortion decreased by a factor of over 4200 as well. This is especially critical when we remember that the human ear is about three times more sensitive to third harmonic distortion than second harmonic distortion.

Referring to the distortion graphs in Figure 4.8(b), note that the second harmonic distortion content began to slowly rise at a little over 500 Hz, just as in the case of Figure 4.7(b). This rise occurs because there were no changes made to any circuit parameter that would effect P1. The P1 frequency is a function of the value of the dominant pole capacitor CC

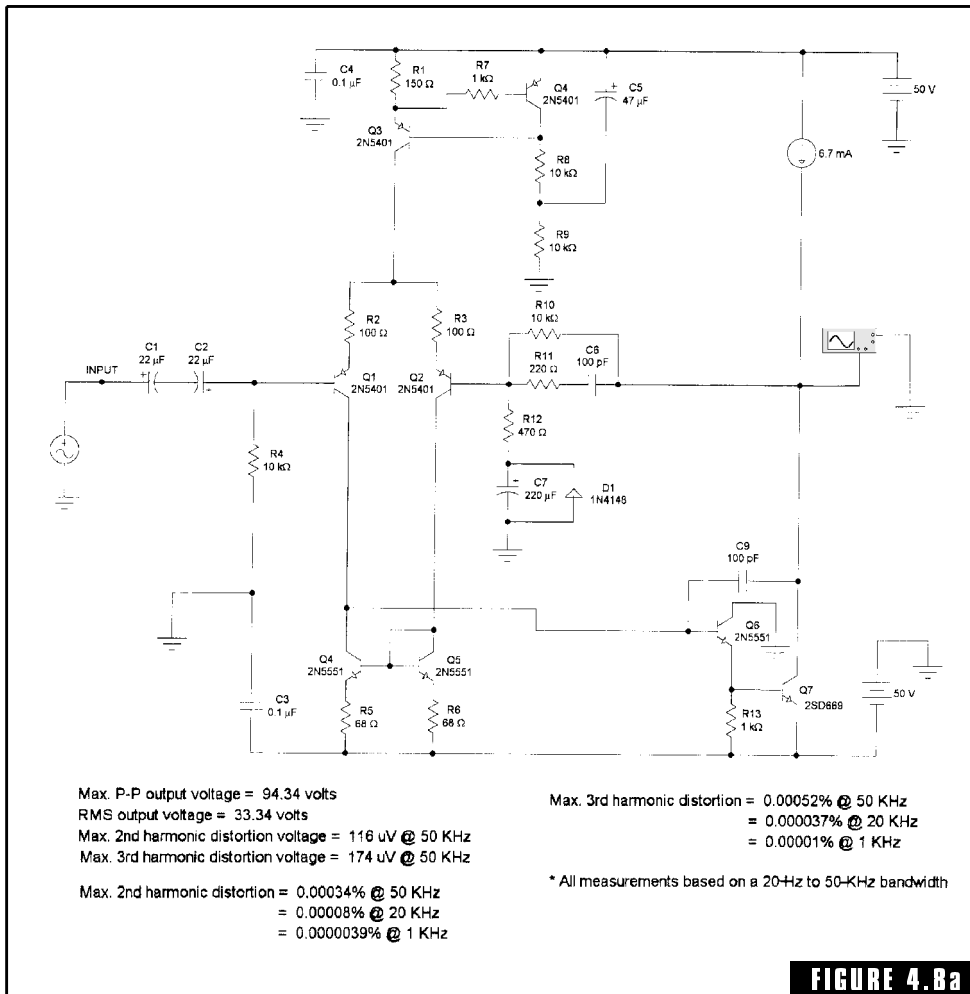

Improved input design utilizing a constant current source for the differential input and a current mirror for differential balance.

and the voltage gain of the VA stage. The improvements to Figure 4.8(a) did not affect either one of these variables. However, the second harmonic distortion content started at a much lower level and increased more gradually due to the degeneration of the differential pair.

Referring to the third harmonic distortion graph in Figure 4.8(b), note that third-order distortion is virtually flat up to around 12 kHz where it begins to rise sharply. This is because, as I stated earlier, the third-order distortion is mainly a result of input stage imbalance and

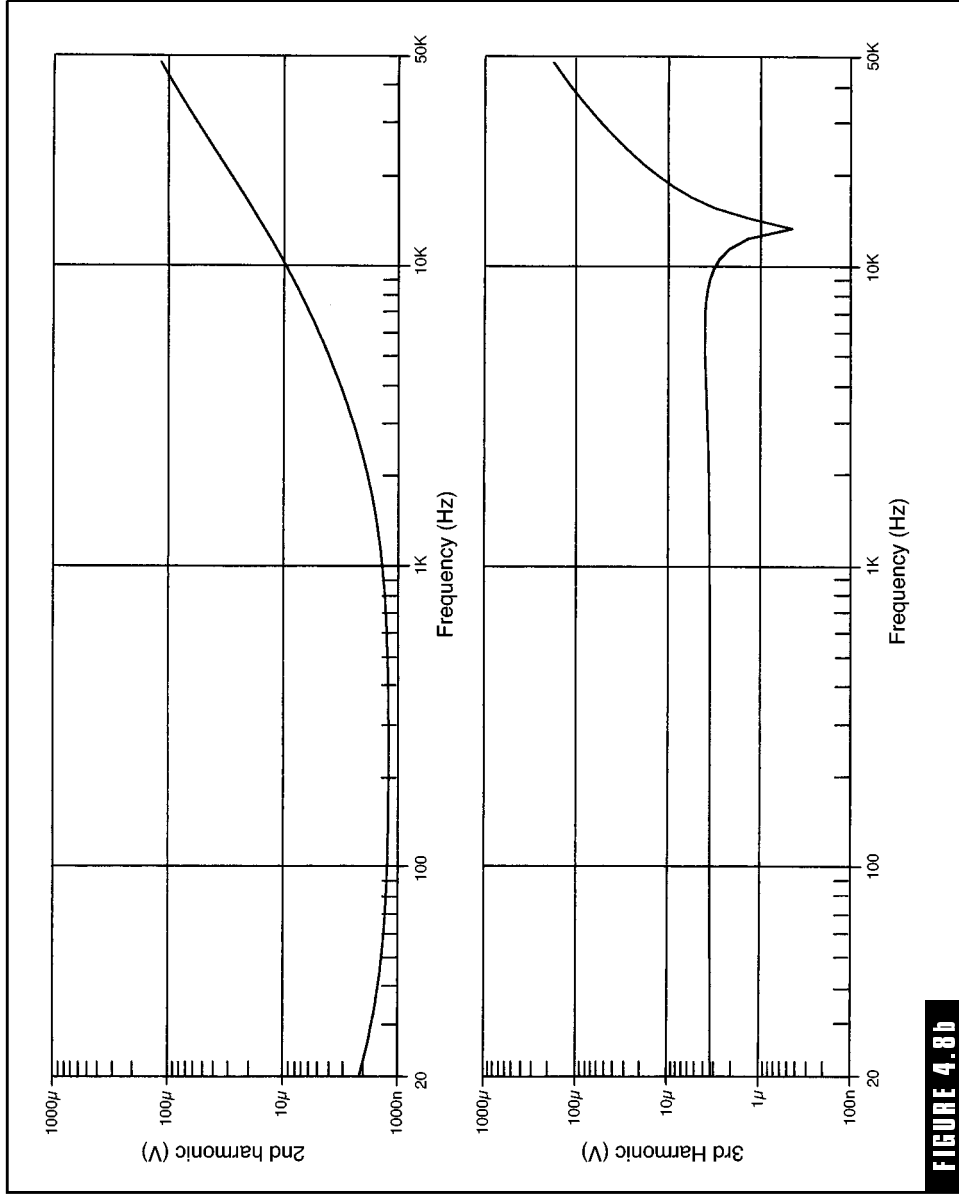

FIGURE 4.8b

Distortion performance of the improved input design of Figure 4.8(a).

current starving. As indicated by the sharp slope of the graph, both of these conditions came into play at around 12 kHz. This situation could probably be improved with a small increase in tail current and a slight reduction in the value of CC (as long as good stability can be maintained). However, this kind of circuit tweaking is hardly worth the effort, because at the third-order distortion levels measured, any improvement is going to be entirely swamped by crossover distortion in the OPS.

There is one extraordinary advantage to the circuit of Figure 4.8(a) that I have not touched on thus far. The perfect amplifier input stage would function entirely on the laws of physics and ratios and be almost totally immune to ill-defined parameters such as precise power supply levels, transistor beta values, or critical resistor values. While the circuit of Figure 4.8(a) is not perfect, it comes close. Beginning at the constant current source, one resistor R1 determines the tail current. The other components in the current source can vary widely with no practical effect upon circuit operation. The tolerance of R1 is not critical because the current mirror automatically forces a current balance in the differential transistor pair, nulling out any reasonable quiescent changes, or drifts, in the tail current value. Since the differential transistor pair Q1 and Q2 function as a transconductance amplifier, their beta values are inconsequential and the degeneration resistors R2 and R3 provide for a very linear transconductance curve. The resistance values of R2 and R3 are not critical; typical values ranging from 22 to 100 ohms result in only minor changes of performance characteristics. For proper operation of the current mirror, Q4 and Q5 should be of the same type and beta-matched, but R5 and R6 degenerate any significant Vbe differences. Again, the exact value of R5 and R6 is not critical. As stated earlier, they are chosen to drop about 50 mV under quiescent current conditions, and their exact value can vary quite a bit without degrading the performance of the current mirror.

QUICK TIP

At this point, you might be wondering why we cannot simply lower the value of CC to raise the P1 frequency and maintain a relatively flat distortion curve throughout the entire audio bandwidth. Remember, if we raise the P1 frequency, we raise the frequency (and associated phase angle) of the upper P1 region where the voltage gain drops below unity. In other words, good dynamic stability is either compromised or lost because the global NFB loop will be at a lagging phase angle of more than 180 degrees while the voltage gain is still above unity. All things considered, the distortion curves of Figure 4.8(b) are about as good as it gets. It's hard to improve on harmonic distortion figures in the "micropercents" at 50 kHz.

Notice that the circuit design is completely irrelevant to rail voltages, transistor beta values, or critical resistor values.

In essence, the principles of improvement imposed upon the circuit of Figure 4.8(a) are basically the same as incorporated within IC op-amp design. A few custom modifications had to be made to accommodate the circuit for audio power amplifier application (such as compensating for the fact that perfectly matched transistors are not available on the same substrate layer), but in theory, a modern high-quality solid-state audio power amplifier is a “big” discrete operational amplifier.

Before leaving Figure 4.8(a), there are a few loose ends to tie up. The voltage balance of the input stage (i.e., the assurance that the base of Q1 will be very close to circuit common, or ground potential) and the voltage balance at the speaker output of the amplifier (an infinitely more serious concern) are fundamentally controlled by a high level of global DC feedback. Assume the input stage is in a quiescent state without any AC signal being applied to the input. The base of Q1 must be at circuit common potential except for the voltage developed across R4 as a function of Q1’s base current. The current source is dictating that about 2.2 mA of current is flowing through Q1’s emitter leg; therefore, if we assume Q1’s beta to be about 200, then around 11 μA of current will flow through R4. This condition impresses about +0.11 volts as a continuous offset on the base of Q1, causing it to be amplified by the differential stage and VA stage (as if it were an AC signal), and it tries to appear at Q7’s collector as a large DC offset. However, the global NFB loop applies the offset as an error voltage at the base of Q2, forcing the VA stage output voltage down to a near-ground potential. The VA stage DC output voltage of Figure 4.8 settled down to an actual value of 4.5 mV.

It is important to note that global NFB for DC offsets is quite different than global NFB for AC signals. This is because C7 represents a near-infinite impedance to DC, causing nearly 100 percent of any DC offset at the VA stage output to appear at the base of Q2. In contrast, an AC signal voltage at the VA stage output will see C7 as a low-impedance path to ground, causing the percentage of AC signal applied to the base of Q2 to be a function of the voltage divider consisting of R10 and R12 (the function of R11 and C6 will be discussed later). Note that D1 is a “protection” diode. In a complete three-stage amplifier design, the global

NFB loop is connected to the OPS. If an OPS failure occurs, causing a potentially high DC voltage to be placed on the global NFB loop, diode D1 protects C7 from being destroyed by a reverse-polarity DC voltage.

Most audiophiles are not concerned with up to 20 or 30 mV of DC offset at the output of their power amplifiers. If you happen to be the type of person who routinely straightens the pictures on your walls with a carpenter's level or neatly folds dirty clothes before putting them in the clothes hamper, you might want to achieve lower levels of DC offset. DC offset is caused by V_{be} and beta mismatches of the differential input transistor pair and resistance mismatches between the emitter degeneration resistors (that is, R2 and R3 in Figure 4.8). By using 1 percent tolerance resistors in the emitter legs and beta matching the differential transistor pair, the DC offset should easily come down to better than 5 mV (and this is without having to use DC servos or trimpot offsets!).

If it is any concern, the DC offsets on the bases of the differential transistors Q1 and Q2 can be reduced by going to a transistor pair with higher beta parameters and/or decreasing the values of R4, R10, and R12. If R4 is reduced to a value of 3.3 k Ω , the positive DC offset at the base of Q1 will drop to somewhere around 25 mV. R10 must be changed to 3.3 k Ω also to maintain balance, causing Q2's base current to develop about the same offset voltage across R10. This modification decreases the effect of beta mismatch in the differential pair, improving the DC offset at the VA stage output as well as decreasing input offsets. Finally, R12 must be decreased proportionally to maintain the same voltage divider ratio for the AC feedback signal. As an overall consequence, the input impedance of the input stage will fall to a value that may not be suitable for all applications (certainly not bridging applications). A side effect of the lower input impedance will be a reduction in Johnson noise, but the real-world improvement is hardly worth the low-impedance disadvantage.

The input stage of Figure 4.8(a) can be the first stage of a high-quality audio power amplifier capable of distortion performance in the 0.001 percent range. The PSRR is excellent, with frequency and gain specifications surpassing the needs of the highest-performance audio amplifiers. Also, with the transistors and components specified, it can function at much higher rail voltages.

Figure 4.9(a) represents an input design that started out with a lot of good ideas. Unfortunately, most of the ideas didn't work out as

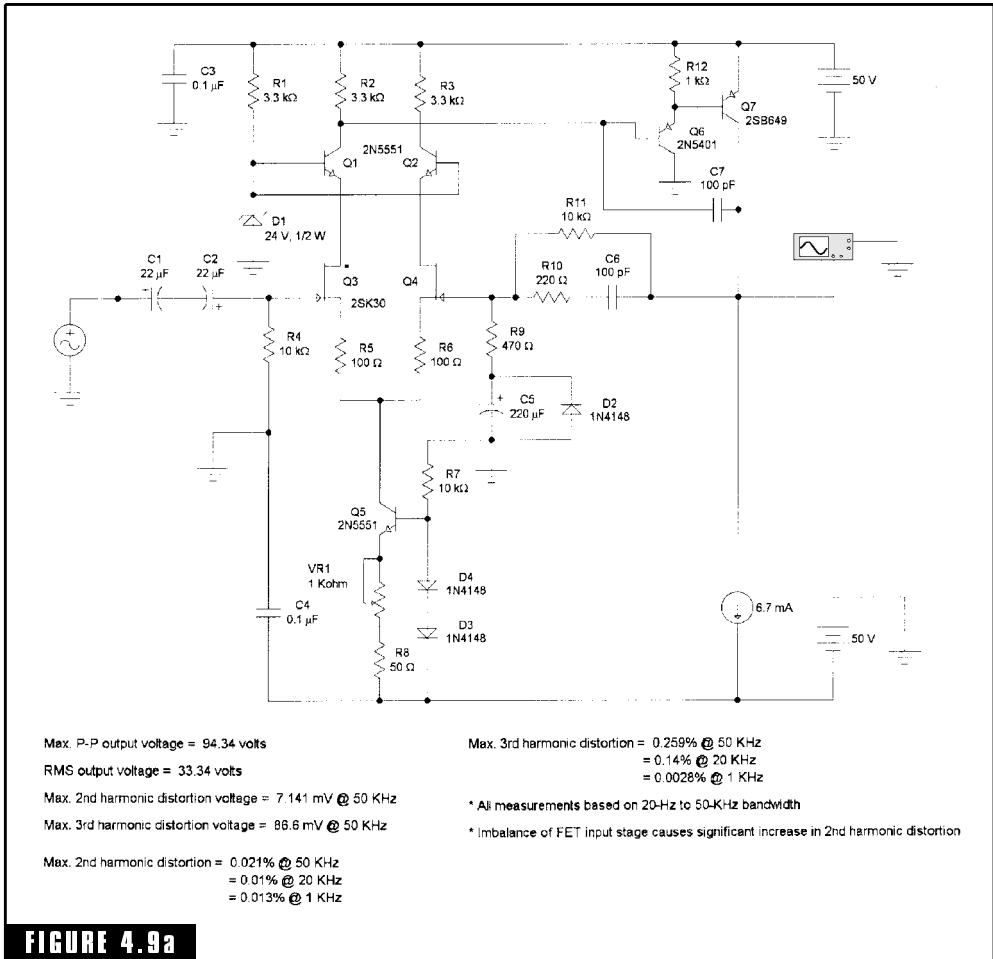

Common type of cascode FET input design.

well as intended. To begin, JFETs cannot perform as well as BJTs for the function of a differential input stage. To state it bluntly, their transconductance is lower, their linearity is poorer, and their V_{gs} parameters vary by a much broader range when compared to even mediocre BJTs. The only real advantage offered by a JFET input stage is the elimination of any DC offset errors at the input. This, of course, is due to the fact that a JFET doesn't draw any gate current. However, this is no small advantage if you intend to direct couple the input.

While on the subject of JFETs, I'd like to comment on a few myths regarding FETs in general. It has been traditionally held that FETs are superior to BJTs regarding noise characteristics due to the lack of *recombinational noise* (that is, noise generated from random recombination of electrons and holes). It is reasonable to assume that the incorporation of JFETs for the differential input stage would provide a significant noise improvement, since the input stage dominates the noise performance of the amplifier. In practice, however, the poor transconductance factor combined with the difficult V_{gs} matching contributes to random noise generation. With all other factors remaining the same, the input stage of Figure 4.9(a) will probably provide a noise characteristic about 5 to 10 dB worse than the circuit of Figure 4.8(a) when used in conjunction with typical audio equipment.

Another misconception that keeps popping up from time to time is the claim that FETs produce a tube sound. This myth probably started from the fact that FETs and vacuum tubes are both considered transconductance (i.e., voltage-in controlling current-out) devices. The only truth within this concept lies in the fact that FETs are more nonlinear than BJTs, producing a consequential increase in even-order harmonics. However, there is also an accompanying increase in odd-order harmonics (not inherent to vacuum tubes), which totally corrupts any real or imagined tube characteristics. The effect of FETs driven to clipping levels is much like that for BJTs. In contrast, the vacuum tube sound is highly reliant on the squashing effect of the audio signal at high drive levels. In sum, the only place you're going to see an actual similarity between FET (or MOSFET) sound and vacuum tube sound is in sales propaganda.

Note: I prefer to use lateral MOSFETs for output devices in all of my high-power audio amplifiers because of reliability factors, not sonics. These devices are discussed in more depth in Chapter 6.

Going back to our analysis of Figure 4.9(a), a cascode stage is formed by Q1, Q2, D1, and R1. This provides the illusion of improved gain and linearity, but its only real function is to isolate the JFETs (Q3 and Q4) from the high-voltage rail (i.e., the rail voltages of the power supply exceed the maximum V_{ds} rating of the JFETs). Because the input stage

is operating as a transconductance amplifier from small input signal voltages, cascoding has little practical effect.

R7, D4, D3, R8, VR1, and Q5 make up a diode-stabilized variable constant current source (as described earlier). A variable constant current source is about the only practical way to achieve a close balance of the input differential stage. In most cases, the heavy degeneration provided by R5 and R6, in conjunction with cancelling out of the nonlinearities inherent to JFETs, will promote a balance at some specific setting of VR1. In some cases, Q3 and Q4 must be swapped around, or another JFET substituted, to achieve balance.

The input stage of Figure 4.9(a) was tested under the same circuit conditions as the previous input stage designs (note how the VA stage had to be turned upside down to accommodate the reversed topology of the input stage). Even though there is much room for improvement, the input stage of Figure 4.9(a) performs reasonably well. A Fourier analysis indicates that there are no horrendous peaks of even- or odd-order harmonics further up the scale and, as indicated by the accompanying specifications in Figure 4.9(a), the second- and third-order harmonics are not bad at 20 kHz. I have built dozens of medium-power (that is, 50 to 100 watts RMS) amplifiers utilizing this input stage for installation in musical instrument amplifiers. The JFET differential stage seems to handle the constant barrage of pops, crackles, and hum resulting from chronic plugging and unplugging of guitar cords without as much balance reaction as some BJT stages appear to suffer.

Referring to the distortion graphs for the input stage shown in Figure 4.9(b), the relatively flat second harmonic distortion curve is indicative of the low-gain, highly degenerated differential stage. The third harmonic distortion curve indicates that current starving began to occur at about 3 kHz. Both of the distortion curves indicate a needed change in the value of the dominant-pole capacitor of the VA stage. In this case, a CC value of around 30 to 50 pF would probably show a marked improvement.

Figure 4.10(a) illustrates what I consider to be the “Cadillac” of input stage design. It is referred to as a *mirror-image topology*, although the term *mirror image* is somewhat loosely applied to some less capable types of input architectures. By comparing Figure 4.10(a) with Figure 4-8(a), it becomes readily apparent that Figure 4.10(a) is simply a push-pull duplication of the single differential stage of Figure 4.8(a).

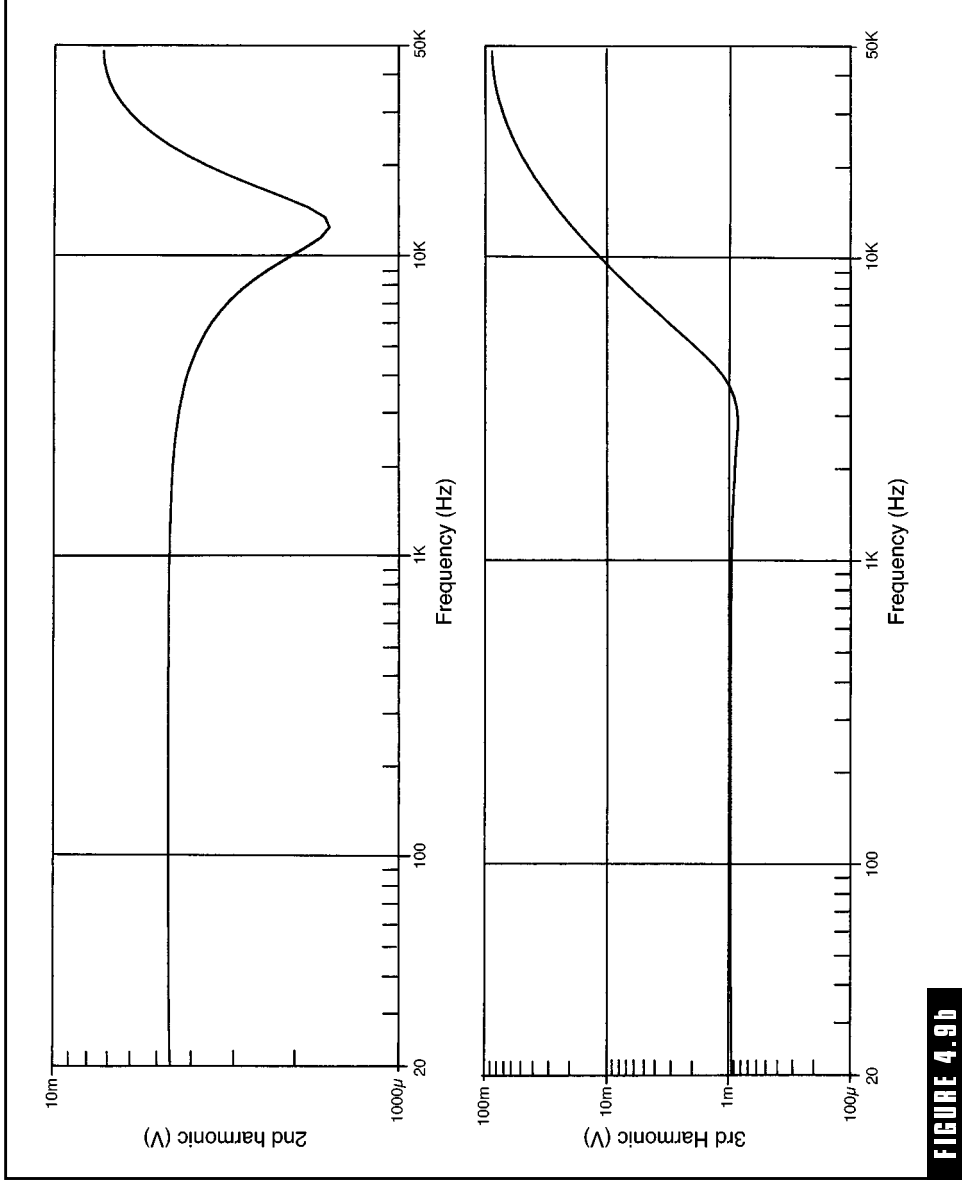

FIGURE 4.9b

Comparatively inferior distortion performance of the JFET differential stage of Figure 4.9 (a).

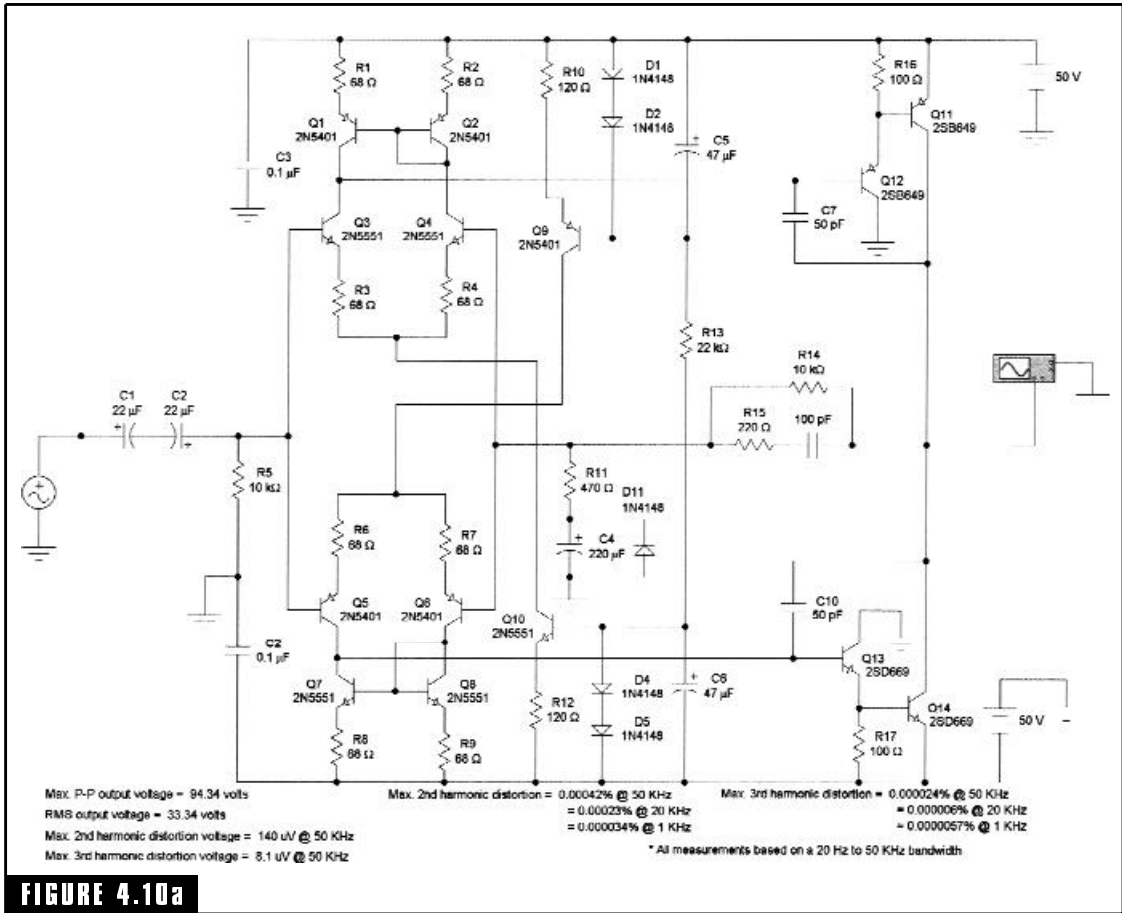

FIGURE 4.10a

A mirror-like topology design illustrating improved third harmonic distortion reduction.

Basically, everything stated about the circuit operation of Figure 4.8(a) is applicable to both differential circuits of Figure 4.10(a); therefore, I won't go over these details again.

Q1 and Q2 make up the current mirror for the differential input stage of Q3 and Q4. R1 and R2 are the Vbe equalizing (degeneration) resistors for the current mirror, and R3 and R4 are the degeneration resistors for Q3 and Q4. The diode-stabilized constant current source for the Q3 and Q4 differential stage consists of Q10, R12, D4, D5, C6, and R13 (note how R13 is a shared current limit resistor for the constant current source of Q9 and its associated components). The differential input stage of Q5 and Q6, and its associated current mirror,

degeneration resistors, and current source, is simply an identical mirror image of the one just described.

Note that the input signal is applied to both differential input stages simultaneously, causing an *equal-but-opposing*, or *push-pull*, action. The global NFB is supplied to the differential stages' inverting inputs simultaneously, creating the same push-pull reaction to feedback linearization. Also note that the VA stage had to be converted to a mirror-image push-pull circuit to accommodate the dual outputs from the mirrored input stages. In other words, we have two of everything, and two is better than one (except in the case of left feet or stage managers).

There are many performance advantages to a well-designed mirror-image topology. Since both differential input stages are working in opposing directions to each other, various undesirable offset traits are effectively nulled out. The input stage of Figure 4.10(a) measured a 12-mV DC offset at the input—still not perfect but a severalfold improvement over the circuit in Figure 4.8(a). However, the DC offset at the output of the VA stage lowered to a fantastic 156- μ V offset! Admittedly, some of this improvement is also a contribution of the push-pull VA stage, but a push-pull VA stage cannot be utilized with the circuit of Figure 4.8(a), so the issue becomes irrelevant.

A mirror-image topology exhibits a very desirable type of mode rejection in two separate planes simultaneously. For example, if we can think of a single differential amplifier stage as rejecting a common mode signal in the horizontal plane (i.e., a common signal on each input—the line drawn from input to input being a horizontal line), we can describe a mirror-image topology as rejecting “differential” signals on the “vertical” plane. In other words, various types of differences (that is, Vbe mismatches, resistor tolerances, small DC offsets, etc.) will have the tendency to be nulled or greatly reduced in their effect. While these things are typically of little concern, the important benefits of such action is a reduction in noise, power supply interference (i.e., the PSRR is greatly improved), and odd harmonic generation.

A typical audio power amplifier will exhibit a marked difference in its *positive* and *negative* (i.e., *rising* and *falling*) *slew rate*. Slew rate asymmetry is a function of the charge versus discharge path of the dominant-pole capacitor CC, which is asymmetrical within the input stage of Figure 4.8(a). In a mirror-image topology, the current sinking and sourcing action shows a significant increase in speed and the charge-discharge path of both dominant-pole capacitors becomes symmetrical. This delightful benefit is

partially due to the splitting of the dominant-pole capacitor and the consequential 50 percent reduction of the current load on each differential stage. It is further enhanced by the improved sinking-sourcing action of both the input and VA stages; thus symmetrical slewing is virtually guaranteed. The input stage of Figure 4.10(a) provides a conservatively rated slew rate of 44 V/ μ s with virtually perfect symmetry.

The input impedance for the input stage of Figure 4.10(a) is, for all practical purposes, the same as for the input stage of Figure 4.8(a). Even by removing the differential degeneration resistors (that is, R3, R4, R6, and R7), the input impedance of Figure 4.10(a) continues to be dominated by R5.

A simple rule-of-thumb procedure can be used to calculate the optimum value of the differential degeneration resistors (that is, R3, R4, R6, and R7). First, determine the value of quiescent current flow for any of the four differential collector legs. With the component values illustrated in Figure 4.10(a), both constant current sources are designed to supply about 5.6 mA of current flow to each differential stage. Since a current mirror is incorporated into each differential stage, the current flow through any of the four collector legs should be one-half of 5.6 mA, or about 2.8 mA. The internal emitter resistance of the differential transistors, referred to as “re prime,” can be calculated from the following simple equation:

$$r_{e'} = \frac{25}{I_{C \text{ per leg in mA}}}$$

Since we have determined that about 2.8 mA is flowing in each leg, 25 divided by 2.8 comes out to $r_{e'}$ of 8.9 ohms. As a general rule, optimum performance is achieved when the total emitter resistance (i.e., the sum of the emitter degeneration resistor and $r_{e'}$) adds up to a resistance value between 25 and 50 ohms. By subtracting $r_{e'}$ from the upper and lower resistance targets, we come up with 16.1 and 41.1 ohms. This represents our targeted range of emitter resistors. Therefore, a good choice for all four of the differential degeneration resistors would be 33 ohms (primarily because 33 ohms is a common standard value).

The distortion graphs for the input stage [Figure 4.10(b)] illustrate the extraordinary performance. The second harmonic distortion graph shows an insignificant increase in comparison to the input stage

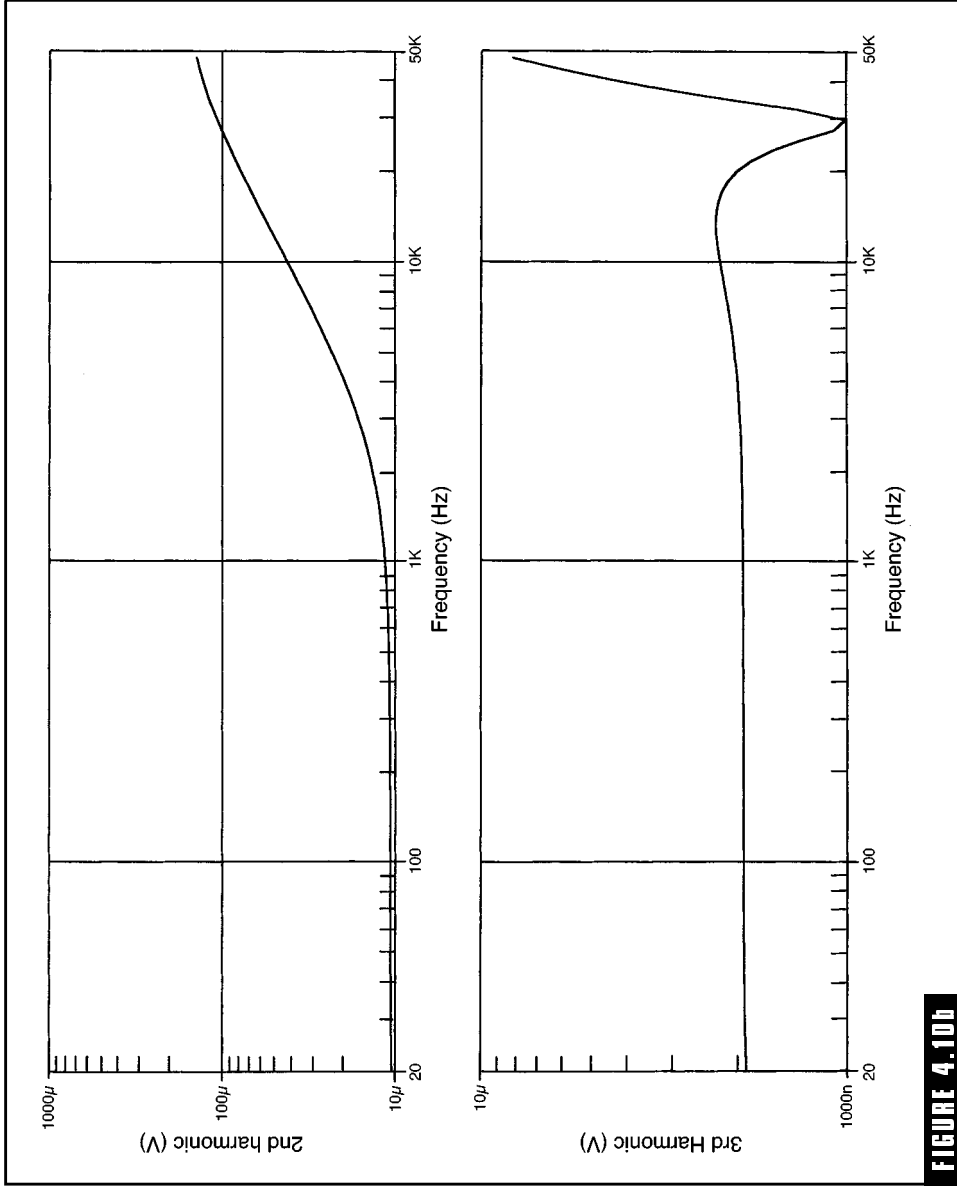

FIGURE 4.10b

Excellent performance of the mirror-image designs in Figure 4.10(a).

design of Figure 4.8(b). However, the good news is that the third harmonic distortion has been pushed well down into the noise floor! The reduction of odd-order harmonics is of much greater importance than even-order harmonics.

The dip and subsequent sharp rise in the third harmonic distortion curve is a result of several factors. Due to the excessive degeneration of the differential stages, the effects of current starvation begin to appear at about 30 kHz (the charge current for the dominant-pole capacitors must pass through Q3 and Q5's emitter resistors). Current starving created an erratic differential imbalance condition, causing the third harmonic distortion curve to rise sharply. I replaced R3, R4, R6, and R7 with 33-ohm degeneration resistors, as previously calculated, and the condition was entirely eliminated. It is worth noting that the third harmonic distortion was already thousands of times below the level of human perception and much lower than in any other design before the resistor modification. But, since there was little effort involved in the improvement, why not strive for perfection?

There is an obvious increase in cost and complexity of a well-designed mirror-image topology input stage. If you are considering going into mass production, cost and complexity will affect every area of production from R&D to final assembly. From a hobbyist viewpoint, however, the increased parts count is not going to significantly affect the overall cost of a superamplifier (all of the transistors specified are relatively inexpensive), and the increased time required to construct it is a labor of love.

Input Signal Conditioning Circuits

So far, throughout our discussions of the technicalities of input stage performance, we have assumed that the input signal consisted of a pure audio signal—identical (except for amplification) to the way we want it to appear at the output of the audio power amplifier. In the real world, such an assumption is not always a good one.

Line-level audio signals that must pass through a variety of switching networks, frequency equalizers, tone controls, cables, and outboard processors may contain a host of undesirable nonaudio interference signals. Interference signals can be radiated through the air, induced through the AC power line, or originate in one or more of the preamplifier stages or coloration circuits. RF interference,

which is especially problematic to high-power audio amplifiers, is often picked up from poorly shielded input cables or defective electrolytic capacitors.

Audio engineers often incorporate various types of input signal conditioning networks to reduce the effects of interference signals upon the performance and stability of the audio power amplifier. In some cases, interference signals simply increase distortion values, but in other situations, they can actually be destructive to the power amplifier and the associated speaker systems.

Input signal conditioning circuits incorporated into audiophile-quality amplifiers are typically first- or second-order passive bandpass filters. In most cases, the low-frequency response is about 3 to 5 Hz, with the high-frequency rolloff point beginning at about 100 kHz. Such circuits have negligible effects upon bass response or slew rates, but they can be very beneficial in some circumstances at improving high-frequency stability. Technically speaking, volume controls and electronic protection circuitry must also be thought of as a type of input signal conditioning. Figure 4.11 provides several good input conditioning circuits that will perform well with the majority of amplifier designs in this book.

Figure 4.11(a) illustrates a simple first-order bandpass filter. Capacitor CC (usually referred to as the *input coupling capacitor*) provides a low-frequency response of about 2 Hz, with the high-frequency rolloff beginning at about 3 MHz. Bandpass and phase responses are shown in the AC analysis for Figure 4.11(a) in Figure 4.12.

Figures 4.11(b) and 4.11(c) are both second-order bandpass filters, providing a more applicable rolloff response than the first-order type (Figures 4.13 and 4.14). Note that the first-order response only rolled off to approximately 50 mV at 100 MHz, whereas the circuits of Figures 4.11(b) and 4.11(c) rolled off to about 10 μ V and 1.5 mV, respectively. Also, the phase lag at 20 kHz is negligible. (Phase lag of input conditioning circuits is irrelevant to Nyquist stability concerns because the conditioning circuit is not incorporated into the global NFB loop.) I prefer to utilize the circuit of Figure 4.11(c) for the mirror-image topologies included in this book.

In the case of many professional musical instrument and public address amplifiers, it is wise to incorporate some form of protection circuitry, and most users desire the installation of a volume control. Figure 4.11(d) is a good example of such a circuit. Its bandpass and phase responses are shown in Figure 4.15.

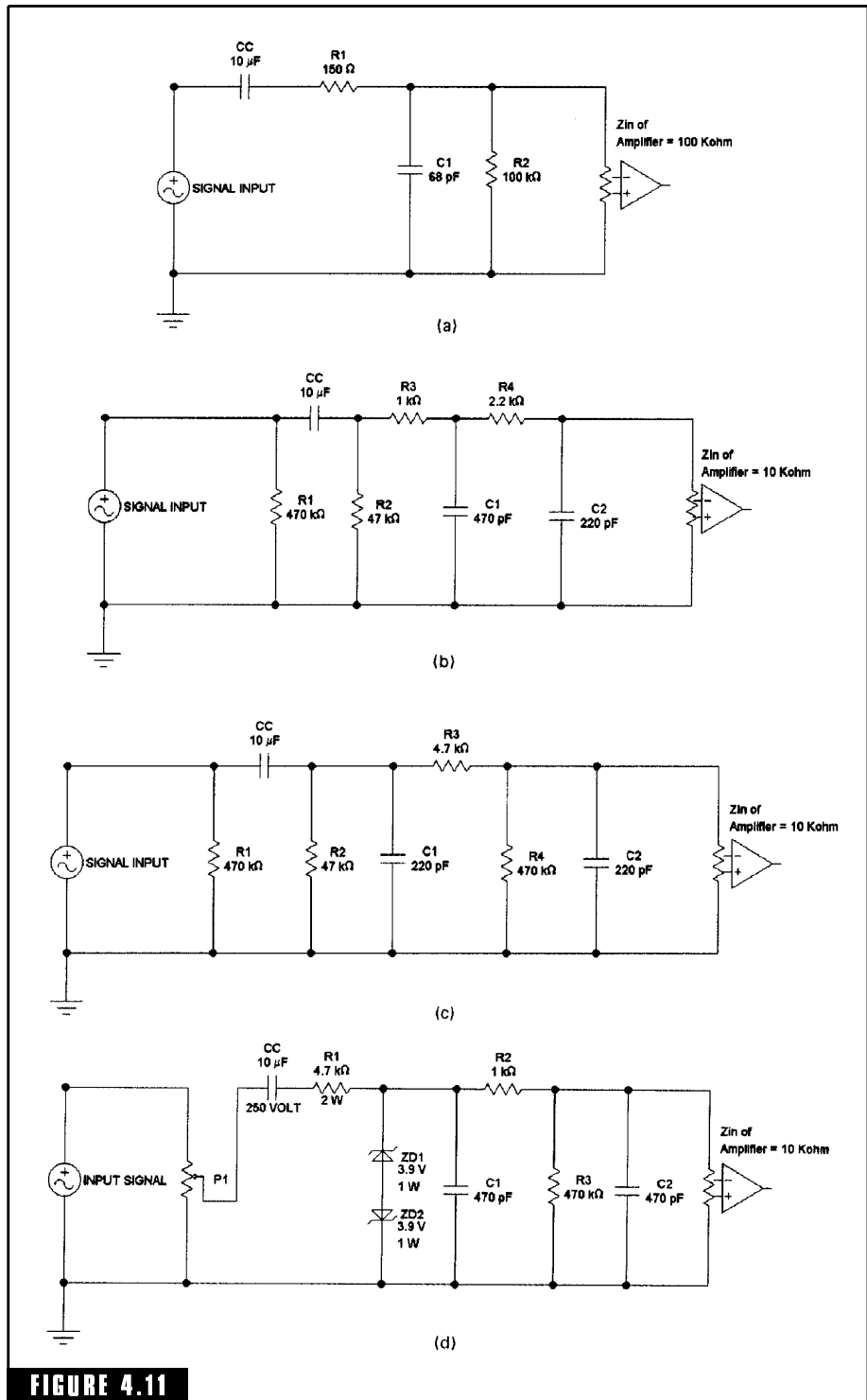

FIGURE 4.11

Examples of audio amplifier input signal conditioners.

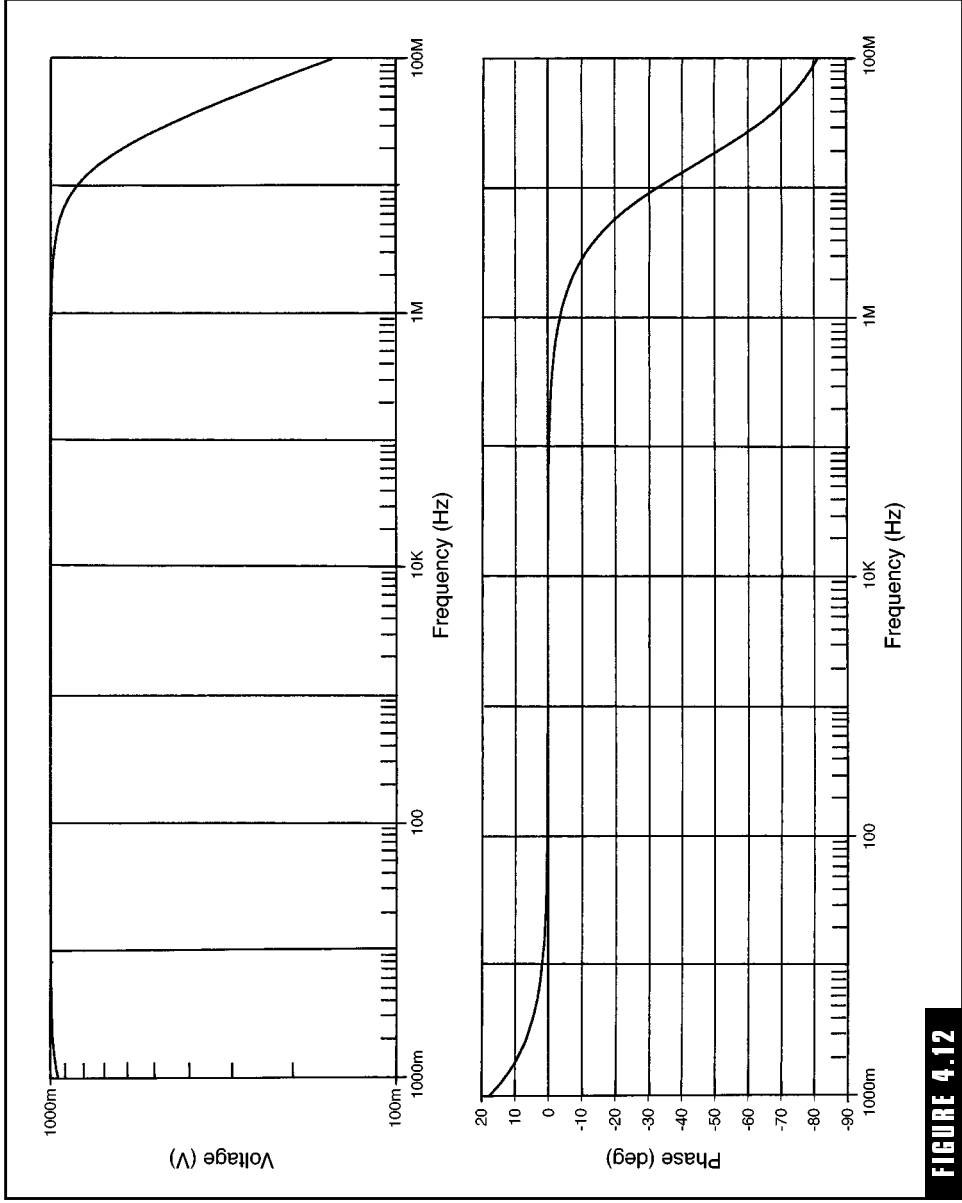

FIGURE 4.12

AC analysis: Frequency and phase response of the Figure 4.11(a) signal conditioning circuit.

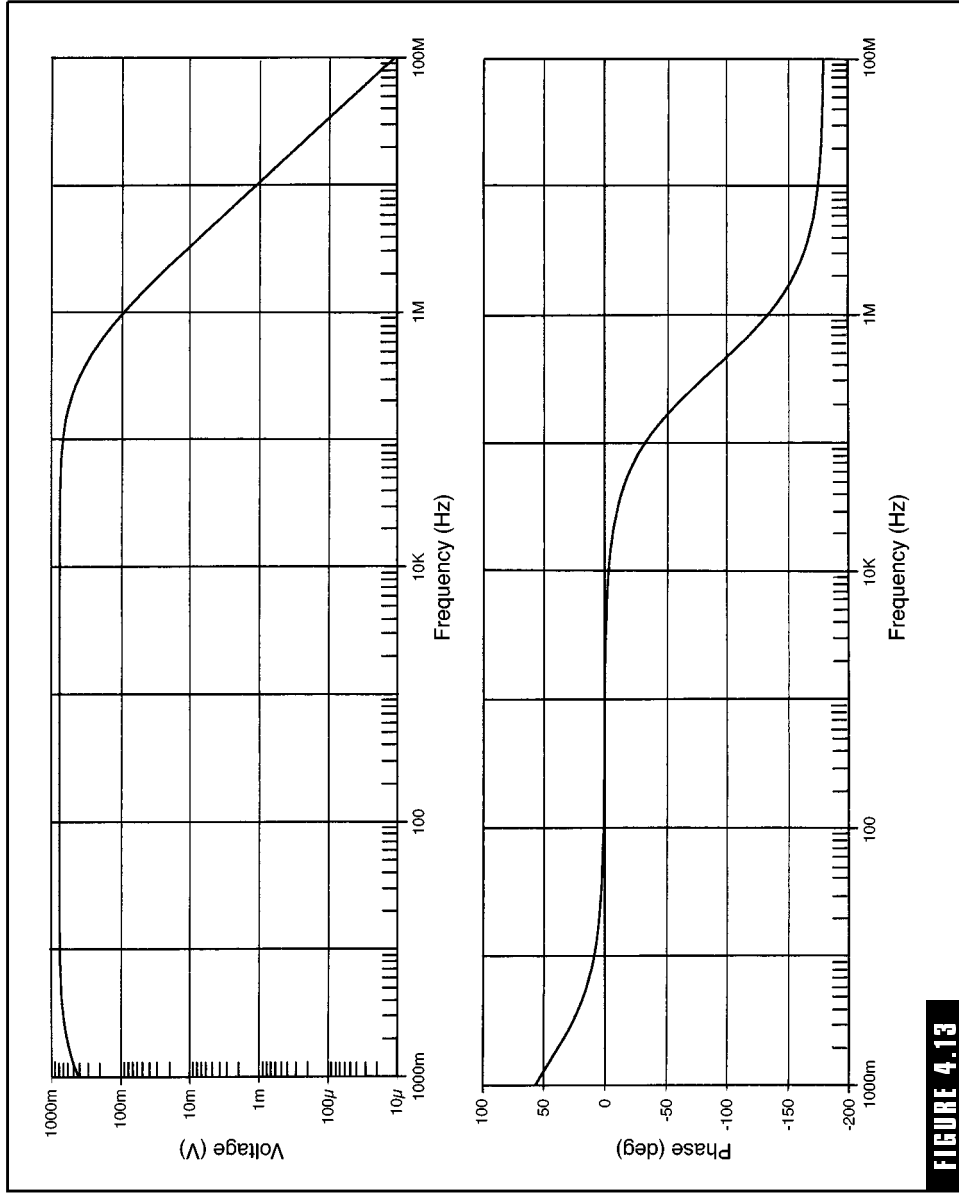

FIGURE 4.13

AC analysis: Frequency and phase response of the signal conditioning circuit in Figure 4.11(b).

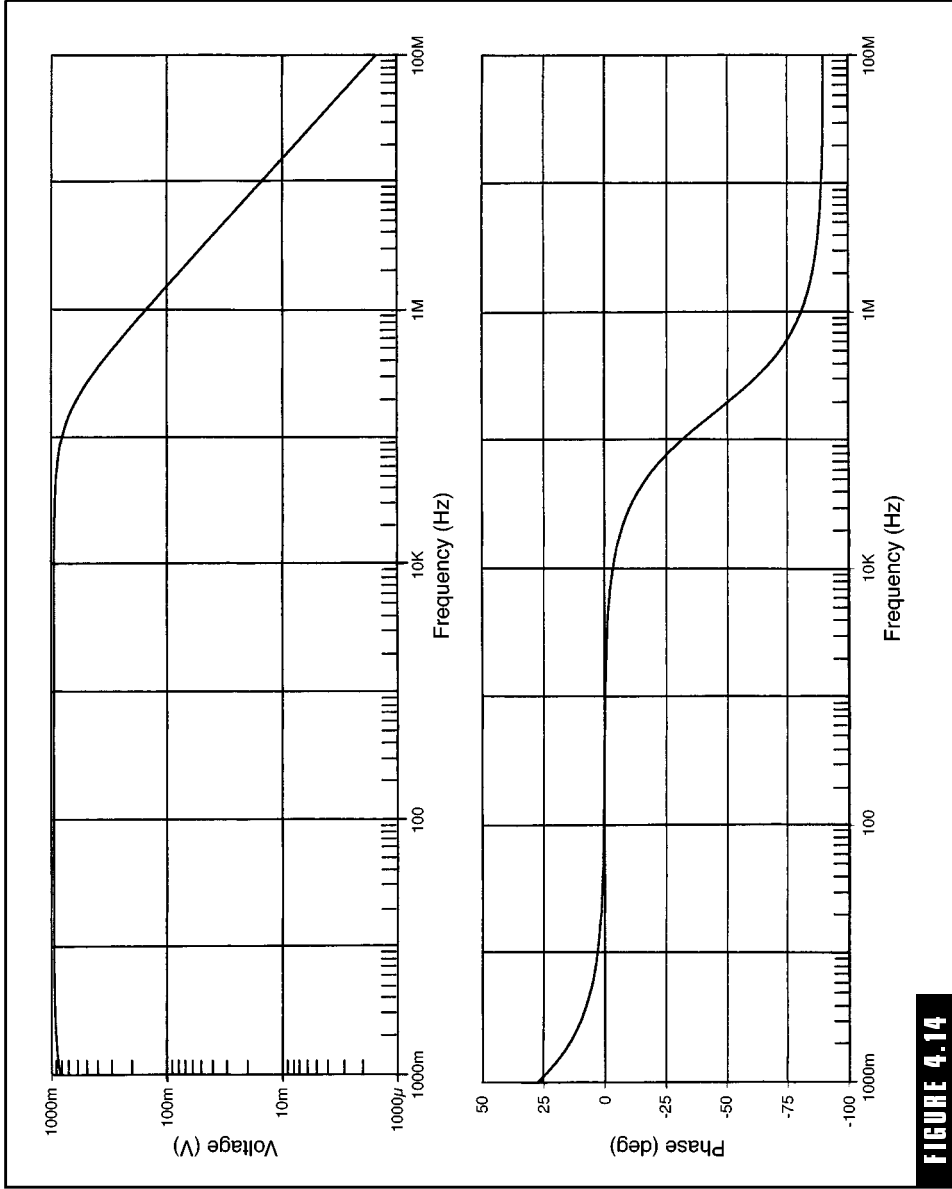

FIGURE 4.14

DC analysis: Frequency and phase response of the signal conditioning circuit in Figure 4.11(c).

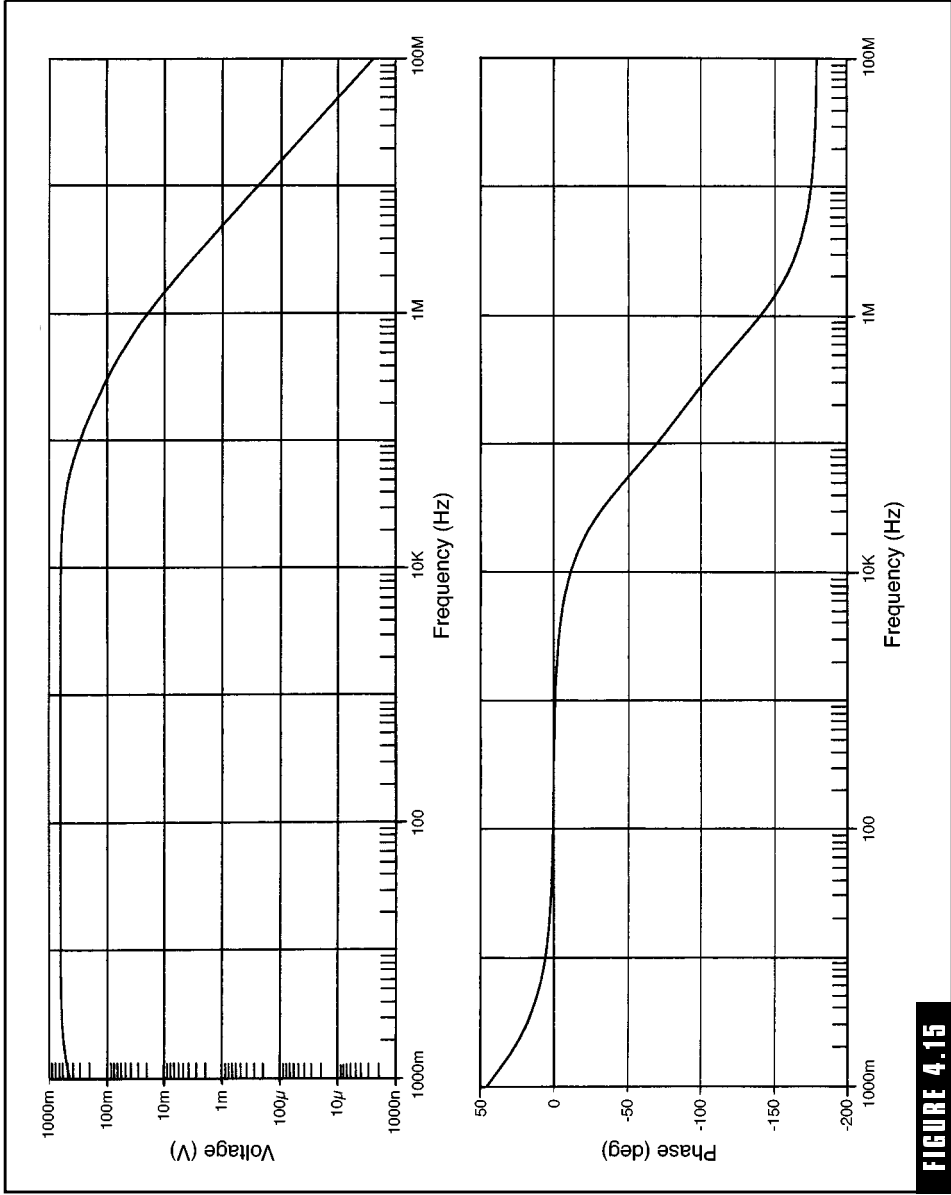

FIGURE 4.15

AC analysis: Frequency and phase response of the signal conditioning circuit in Figure 4.11 (d).

Professional audio equipment is constantly at risk from connection errors. For example, many professional speaker cables are fitted with $\frac{1}{4}$ -inch plugs, identical to musical instrument cords. It is very easy to accidentally plug a speaker output cable into a power amplifier input jack, resulting in destructively high voltages being applied to the input stage electronics. Compounding this problem is the reality that a professional amplifier will often be set up by personnel who are totally inexperienced in the field of audio electronics, so errors are common. The long input cables running from mixing consoles to power amplifiers can also become ferocious antennas for RF interference if the shield is poor or damaged (damaged cables are a daily occurrence in the lives of professional entertainers). For this reason, the bandpass of many input conditioning circuits are narrowed for audio amplifiers intended for professional applications

Referring to Figure 4.11(*d*), the value of P1 is usually chosen to be roughly equivalent to the input impedance of the power amplifier. Coupling capacitor CC should be a high-voltage (i.e., about 250 V), metalized polypropylene type. For musical instrument amplifiers, its capacity value can be substantially lower. ZD1, ZD2, and R1 form a clamping circuit to limit the maximum peak-to-peak voltage that can be applied to the input stage electronics. At typical line-level voltages (i.e., about 1 V RMS), the clamping circuit is totally inactive. If destructive high voltages are accidentally applied to the amplifier input, ZD1 and ZD2 will clamp the voltage at about 4.5 volts peak, thereby protecting the input transistors (the 2N5551 and 2N5401 transistors specified for the majority of input stages in this book have a maximum emitter-base voltage of 5 volts). The oscillogram of Figure 4.16 shows the conditioning circuit's output voltage when 250 V AC RMS is applied to the input (with the volume control adjusted to maximum output). The values of CC, ZD1, and ZD2 are chosen so that the AC power line voltage can be directly applied to the amplifier input for approximately 1 minute without resulting in any damage to the amplifier or conditioning circuit; however, depending on its setting, P1 may be destroyed.

The remainder of the Figure 4.11(*d*) components make up a second-order bandpass filter (including capacitor CC). The AC analysis charts for Figure 4.11(*d*) illustrate how the bandpass response has been greatly narrowed, with the high-frequency rolloff beginning at about 30 kHz.

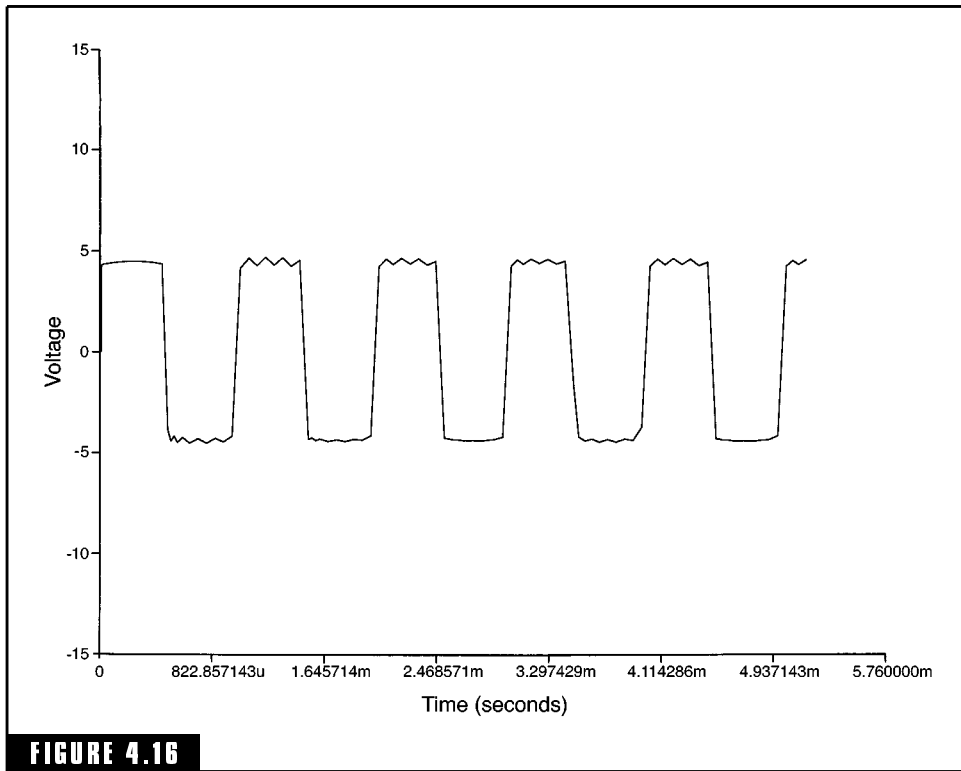

FIGURE 4.16 Oscilloscope: Protective clipping action of the signal conditioning circuit in Figure 4.11(d).

With the component values shown, the circuit of Figure 4.11(d) will definitely compromise the high-frequency performance of a high-quality audio amplifier. If you prefer not to have such extreme bandwidth reduction, the capacity values of C1 and C2 can be reduced.

Some audiophiles do not like to incorporate any input signal conditioning, and this practice is acceptable for most domestic hi-fi applications. However, I do believe it is wise to incorporate at least a first-order filter in MOSFET power amplifiers since they are more susceptible to high-frequency instability.

The circuits illustrated in Figures 4.11(a) through 4.11(d) are general purpose in nature, so you can swap around component values to modify the circuits according to your preferences. The AC analysis charts should provide you with a good foundation to make an educated “guesstimate” of the response relative to component changes. Or, if you prefer, conditioning circuits are easy to analyze with a signal generator and oscilloscope.

Summary

The first generation of solid-state input topologies were single transistor stages with global NFB applied to the emitter. This type of design is so inadequate by modern standards that it is not represented within the context of this chapter. The second generation of input stages, represented by the typical circuit of Figure 4.7(a), incorporated a differential stage and functioned in a true transconductance manner. However, there was still much room for improvement.

The third generation of input stages, a typical example illustrated in Figure 4.9(a), utilized the dubious benefits of JFETs and cascode stages (probably due to marketing pressure) and the significant improvements inherent with constant current sources.

The input stage topologies represented in Figures 4.8(a) and 4.10(a) incorporate the advantages of operational amplifier characteristics and push the performance characteristics of input stage design to the near-perfect realm. The incorporation of current mirrors and mirror-image architecture simplifies design and improves noise, slew rate, and PSRR to the point of almost obtaining the Holy Grail of input stage design—a straight wire with gain!

From the practical viewpoint, the circuit designs of Figure 4.7(a) and 4.9(a) are not completely outdated. When properly implemented, the input stage topology of Figure 4.7(a) still has a place in low-cost, low-power applications. As I stated earlier, I like to use the topology of Figure 4.9(a) for low- to medium-power musical instrument amplifiers. However, the hard-core audiophile is not going to be satisfied with less than the performance offered by input topologies such as Figures 4.8(a) and 4.10(a).

This page intentionally left blank.

Voltage Amplifier Stage: Configurations and Analysis

Purpose and Function of the VA Stage

As its name implies, the VA stage is responsible for all of the voltage gain within a typical audio power amplifier.* The VA receives a buffered and current-amplified output signal from the input stage and converts it to a large-signal voltage to be applied to the OPS. As frequency increases above P_1 , the input and output impedance of the VA begins to fall as the capacitive reactance of the dominant-pole capacitor drops. The decrease in VA impedance has a minimizing effect of Miller capacitance within the input and output stages, forcing the dominant-pole capacitor to become the primary capacitive influence on the entire amplifier. Therefore, the compensation variables for

*There have been a few power amplifier designs incorporating voltage gain in the OPS. The primary motivation for this design approach has been the unavailability of high-quality high-voltage complementary output devices. Now that these are readily available, the technique is pointless and somewhat impractical.

Nyquist stability and optimum linearization are reduced to the combined effects of the input stage transconductance, the voltage gain of the VA, and the value of one capacitor (the dominant-pole capacitor, or CC).

As you may recall from Chapter 4, the action and performance of the input stage is affected by the balance of the differential pairs (optimized by current mirror incorporation), differential tail current (dictated by constant current sources), linearizing differential degeneration, and current mirror degeneration. Of these variables, the only practical design options available to us are the levels of degeneration and the differential tail current(s). Degeneration options are held in pretty narrow restraints because if we try to excessively degenerate the input stage (increasing local linearity), the overall gain of the amplifier drops (decreasing linearizing global NFB), and we end up where we started. Excessive increases in tail current can result in increased noise and destructive levels of power dissipation, so we are limited in this area also. The point is, once the input stage is optimized, we are left with few design options in this area (the exception being, of course, to go to different device types).

Assuming the input stage has been taken to its near limit, optimum compensation and linearization are simplified down to two variables: the voltage gain of the VA and the value of the dominant-pole capacitor. Voltage gain should be as high as possible without adding unnecessary complexity or destabilizing circuitry. The optimum value of CC is chosen to provide good stability and the maximum utilization of global NFB.

The smooth transition from global to local NFB is extremely important to power amplifier operation. This transition occurs in the VA stage as a function of the dominant-pole capacitor and the high-voltage-gain factor. As the signal frequency exceeds the P1 frequency, capacitor CC begins to supply linearizing local NFB to the VA input. Since NFB within the VA is contained within a local loop, stability should not be a concern, even at very high frequencies (a VA design would have to get pretty complex to break into self-sustaining oscillation).

QUICK TIP

Remember that if we drop below unity gain too soon, we lose the beneficial effects of global NFB at reducing crossover distortion.

Common Misconceptions Involving the VA Stage

If you were working on a three-stage power amplifier that was suffering with linearity problems, remembering that all

voltage gain (and the maximum voltage swing) had to originate in the VA stage, which stage would you investigate first in the attempt to find the problem? The VA stage, right? Wrong! Of the three stages in a typical Lin topology, the VA stage is least likely to create any significant distortion problems, if it is working at all.

In the low-frequency region (below $P1$), the VA is linearized by the effects of global NFB. Above $P1$, the VA is linearized by local NFB through the dominant-pole capacitor. In contrast, the input stage and OPS must depend almost entirely on global NFB for linearization (except for some linearizing benefits obtained through degeneration). The VA provides a linearized output signal to the OPS as a result of its local NFB loop, but at high frequencies, the input stage is pretty much on its own. However, as will be illustrated shortly, this situation is not as bad as it sounds. A properly designed input stage will remain linear with very little global NFB.

The poor high-frequency performance of many commercial amplifiers is due to various misunderstandings regarding the VA and how it harmonizes with the actions of the remaining two stages. Past attempts at locally linearizing the VA at low frequencies (when the global NFB does the best possible job) have resulted only in minimizing the benefits of the three-stage topology. The subjectivist perspective of trying to internally linearize each stage before the application of global NFB is the worst possible approach to building power amplifiers. The mere existence of today's high-performance operational amplifiers proves this approach to be a fallacy.

Typical VA Stage Configurations

A brief examination of Figure 5.1 is all it takes to recognize that there are many different approaches to constructing a VA stage. Based on the optimum VA requirements discussed thus far, refer to Figure 5.1 as I provide a brief discussion of each topology.

Figure 5.1(a) VA stage with current source load: As illustrated, the input stage and OPS are represented with an amplifier symbol so that the VA stage can be viewed in isolation. This circuit represents a very common design, with a constant current source in place of a passive resistor. The current source acts as an active resistor and provides for a maximum

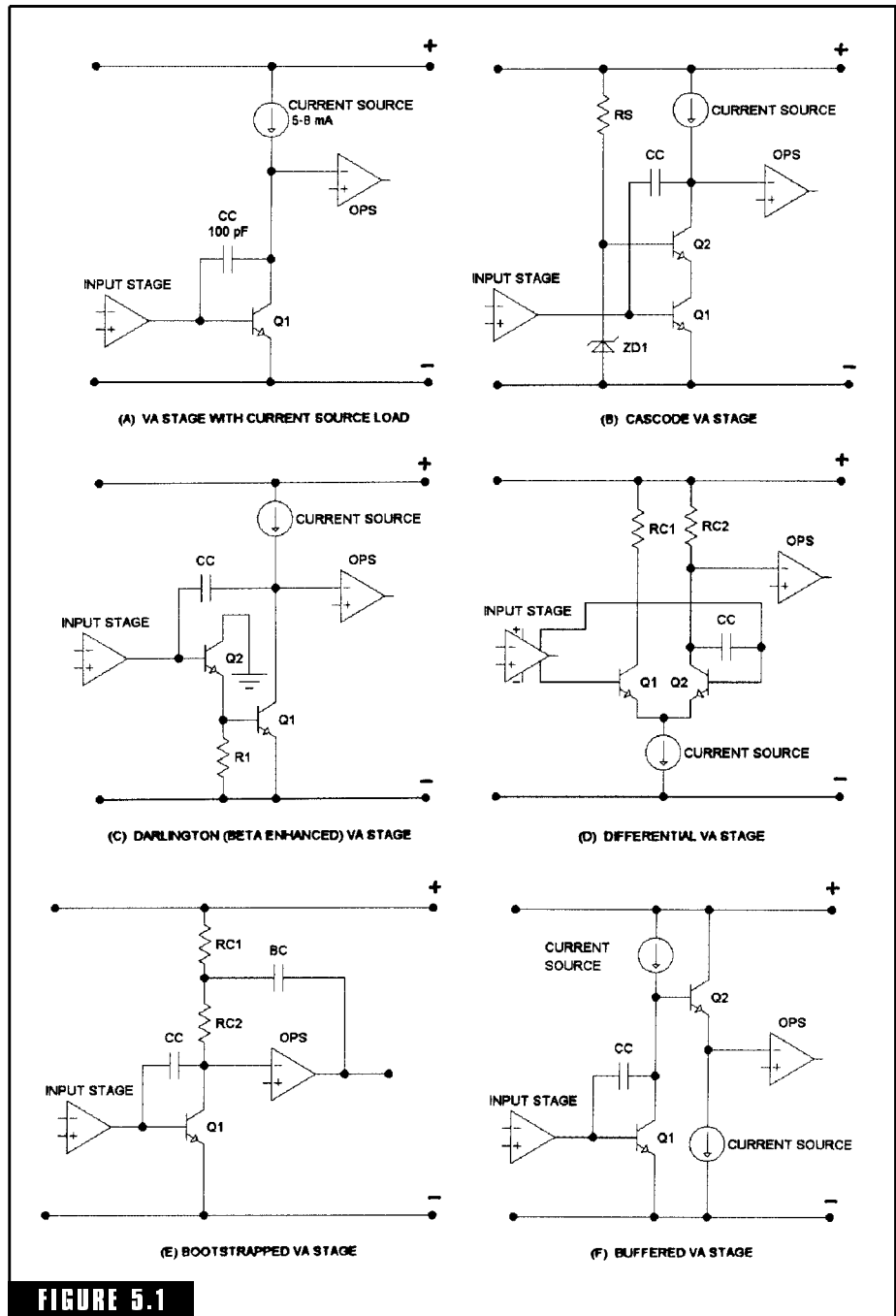

Illustrations of various VA stage topologies represented in their basic forms.

utilization of the transistor's gain (β) parameter while increasing the current sourcing capability of the VA (adequate current sourcing is required to drive the OPS to the maximum rail voltage). The disadvantage of this circuit is that the transistor must be a high-voltage type (capable of withstanding the sum of the rail voltages), and it would be preferable to have a higher gain factor than can be provided by a single transistor.

Figure 5.1(b) Cascode VA stage: A cascode transistor stage (Q2) is another type of active loading technique. It further increases Q1's collector impedance and improves the gain factor. In addition, Q2 effectively isolates Q1 from the upper rail voltage. Thus, Q1 can be replaced with a low-voltage, high-beta type for further gain enhancement. This circuit is especially applicable to OPSs incorporating power MOSFET devices. When trying to directly drive BJT outputs, the low-impedance nonlinearities of BJT devices will drive the high-impedance output of the cascode stage into nonlinearities. An additional transistor buffer stage will eliminate this problem.

Figure 5.1(c) Darlington VA stage: The Darlington VA stage represents the simplest way to solve the most problems. In fact, I haven't

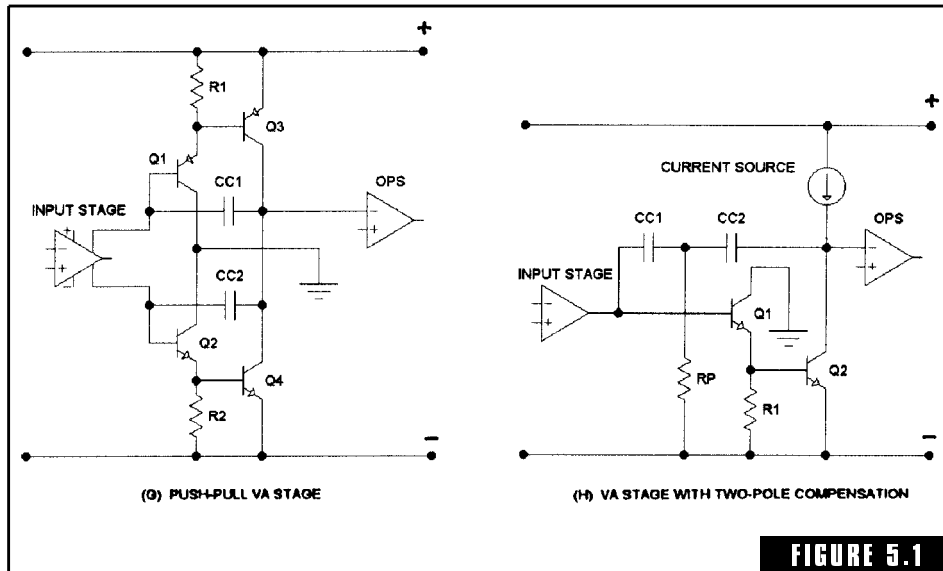

Illustrations of various VA stage topologies represented in their basic forms. (Continued)

really found any significant shortcomings with this circuit design. The additional gain factor significantly improves the local feedback through CC, and there isn't any practical need to revert to a cascode stage for additional collector impedance. Q1 is capable of sourcing more current to the OPS than a cascode configuration, and it can remain a high-voltage, low-beta type without any degradation of performance (the product of Q1 and Q2's beta parameters will be sufficient even if they are on the low side). R1 is for DC stabilization, with typical values ranging from about 1 k Ω to 100 ohms.

Figure 5.1(d) Differential VA stage: In general, differential VA stages have little in their favor. The evolution of differential VAs was a result of the erroneous linearize-before-global-NFB concept. A differential VA will not improve the linearity performance of the Darlington approach (as previously discussed), so there seems to be little point to the added component count and complexity. In addition, if both differential outputs from the previous input stage are being applied to a differential VA, a type of settling distortion can be injected if the VA is not perfectly balanced. If we go to the additional trouble of adding current mirrors, it begins to behave poorly as a transimpedance amplifier. A differential VA does have the advantage of providing more voltage gain when combined with an input stage of low transconductance. In this respect, a differential VA may be the best choice for amplifiers incorporating FETs for input differential devices.

Figure 5.1(e) Bootstrapped VA stage: Bootstrapping is another active load technique, comparable to utilizing a constant current source. It is less expensive to incorporate than a current source, but it is harder to optimize. Bootstrapping requires the voltage feedback from the OPS; consequently, it is at the mercy of variations at the output resulting from deviations in speaker impedance and/or activation of V/I circuitry. Reason dictates that a constant current source is a more dependable and stabilized active load technique.

Figure 5.1(f) Buffered VA stage: Whenever impedance nonlinearities of a BJT OPS cause distortion loading on the VA, a buffering stage will eliminate the problem. It is also a little-known fact that a properly designed buffer stage can minimize input capacitance problems in

MOSFET OPSs. The emitter-follower stage illustrated is a common method. Any added C_{BC} effects should be negligible regarding Nyquist stability.

Figure 5.1(g) Push-pull VA stage: Perhaps this topology should have been called a “complementary Darlington,” because that is precisely what it is. Referring back to Figure 5.1(c), note that it consists of an additional Darlington stage tied to the opposing rail. This configuration is typically used in conjunction with a mirror-image input stage topology. It provides an improved PSRR over the single Darlington design, and facilitates the splitting of the dominant-pole capacitor (illustrated as CC1 and CC2). When used in conjunction with a properly designed mirror-image input stage, slew rate speed and symmetry are greatly improved (slew rate symmetry is virtually guaranteed), as well as the other advantages previously discussed regarding mirror-image topology.

Figure 5.1(h) VA stage with two-pole compensation: As explained previously, the value of the dominant-pole capacitor must be chosen so that the closed-loop gain of the amplifier drops below unity before a phase shift of sufficient proportion can place any amount of positive feedback on the global NFB loop. Utilizing a single capacitor for the dominant-pole capacitor CC provides a 6-dB/octave rolloff of open-loop gain as the signal frequency increases above the P1 frequency. Two-pole compensation (as illustrated in Figure 5.1(h)) provides a means of modifying the open-loop gain rolloff slope to about 12 dB per octave for a portion of the high-frequency bandwidth. In effect, the P1 frequency is moved upward (although this is not technically the case), providing the full benefits of nonattenuated open-loop gain throughout the entire audio bandwidth. When open-loop gain does begin to roll off, it decreases at a 12-dB per octave rate for a portion of the slope, and then returns to a 6-dB per octave rolloff prior to reaching the unity gain point.

Although there are many additional variations of VA stage design, Figure 5.1 provides a good sampling and illustrates the fundamental principles involved. It can justifiably be stated that the optimum VA stage would consist of a Darlington push-pull topology incorporating

two-pole compensation. The topology of such a design will be discussed a little later.

Determining the Value of the Dominant-Pole Capacitor

As I stated earlier, the optimization of the input stage is a fairly rigid affair. When completed, the only variables remaining to play with are the tail currents and degeneration resistors. It is desirable to use as little degeneration as needed; otherwise, we begin to suffer from a reduced open-loop gain factor. Therefore, we really don't have a lot of optional variance in this area. The only variable left is the tail current(s). Up to this point, I have purposely left out any mention of optimizing the input differential tail current(s) because it (they) will ultimately depend on the value of the dominant-pole capacitor CC.

Since the input impedance of the VA stage begins to drop with increasing frequency above the P1 frequency, the current sourcing requirements of the input stage begin to increase proportionally above P1 also. In simple terms, the input stage must have a high enough quiescent current to supply the charging needs of CC at high frequencies.

The equation for calculating the peak charge current of CC (CC_{IPK}) relative to frequency is as follows:

$$CC_{IPK} = 6.28 \times \text{frequency} \times CC \text{ (farads)} \times E_{PK(VA)}$$

Let us walk through a sample calculation for demonstration purposes. Assume you want to determine the peak current requirement from the input stage for a CC value of 100 pF at 50 kHz driving an 8-ohm load at 200 watts RMS. The product of 6.28, 50 kHz, and 100 pF comes out to 0.0000314. The peak voltage of the VA [$E_{PK(VA)}$] can be assumed to be the peak output voltage needed to drive an 8-ohm load at 200 watts RMS (the OPS can be considered as providing unity voltage gain for calculation purposes). Utilizing the common Ohm's law power calculations, the peak voltage across the load, which is assumed to be the peak voltage output of the VA, is about 57 volts. The product of 0.0000314 and 57 is 1.79 mA. Therefore, the input stage will be required to supply a peak charge current (CC_{IPK}) of 1.79 mA to accommodate CC at 100 pF at 50 kHz.

As a rule of thumb, simply multiply the calculated value of CC_{IPK} by a factor of 4, and this current value becomes the tail current setting

for a “single” BJT differential input stage. In the previous example, a tail current setting of about 7.16 mA (that is, 4×1.79) would be indicated. If a mirror-image topology is being utilized for the input stage, each of the constant current sources for the two differential stages should be set to about 60 percent of the previously calculated value (that is, 60 percent of 7.16 mA). If the input stage utilizes an FET differential stage, leave the tail current at its calculated value and reduce the capacity value of CC by 60 percent (i.e., change the value of CC from 100 to 40 pF).

It is not critical that the input stage tail currents be set to the exact calculated values. If, for example, you were building a constant current source such as the one illustrated in Figure 4.2 of the previous chapter, the nearest standard value resistor that would provide a constant current output close to 7.16 mA is 91 ohms. This would provide about 7.3 mA, which is within 10 percent of the calculated value.

By now, the astute reader will have recognized that I did not calculate an optimum value for CC. Rather, I arbitrarily chose a value for CC (100 pF) and “back-calculated” a value for input differential tail current. If my calculated tail current had been outside reasonable limits, I would have chosen a more appropriate value of CC and recalculated. In the practical sense, this is the easiest way to do it. The alternative would be to calculate the transconductance and transimpedance of the input and VA stages, respectively, calculate open-loop gain, calculate the optimum P1 frequency, and calculate the required CC value. Since this would require considerable educated guesswork regarding the value of some unknown variables (such as the beta of a Darlington VA stage), it is doubtful that the calculated answer would be any more accurate than the infinitely simpler rule of thumb. Typical values of CC will vary from 10 pF (used in some older, high-power quasi-complementary public address amplifiers) to about 300 pF.

It is important to understand the theory behind modifying the input tail current(s) to match a chosen CC value. As you recall, the overall gain for a three-stage amplifier is the product of the input transconductance and the VA transimpedance. The differential tail current profoundly affects the input stage transconductance. By calculating an optimum value of tail current to match the value of CC, we are, in essence, setting the approximate open-loop gain of the amplifier so that the P1 point will end up where we want it to be.

This method of determining the value of CC is not as crude as it may seem at first thought. Once the critical aspects of input and VA stage design have been dealt with, we are allowed a pretty broad deviation of the literal P1 frequency without adverse effects in performance or stability. This virtually has to be the case because transistor beta values used in the VA stage will vary quite radically.

Understanding Two-Pole Compensation

Referring to Figure 5.1(h), CC1 is chosen to be the same value as if typical single-pole compensation were to be implemented. As a rule of thumb, CC2 is simply made 10 times higher in capacity value than CC1. R_p is typically about 1 K Ω .

CC2 and R_p form an AC voltage divider from the collector of Q2 to the negative rail. At low frequencies, the impedance of CC2 is very high in comparison to the resistance of R_p , so only an insignificant percentage of the NFB signal is actually seen by CC1. As the signal frequency increases, the impedance of CC2 drops, until a frequency is reached wherein the impedance of CC2 and R_p are about equal. This is the frequency at which the open-loop gain begins to fall. If two-pole compensation is properly implemented, this frequency could be well into the ultrasonic region.

As frequency continues to increase above the open-loop gain rolloff point, two simultaneous things begin to happen. The impedance of CC2 drops by about 6 dB per octave causing an increase in voltage amplitude across R_p of about the same. The impedance of CC1 is also decreasing by about 6 dB per octave, increasing the amount of NFB applied to Q1's base. The additive effect of the 6-dB rising voltage across R_p , combined with the 6-dB decreasing impedance of CC1, causes the NFB signal applied to the base of Q1 to increase by 12 dB per octave. Consequently, this causes a 12-dB per octave open-loop gain rolloff. As frequency continues to increase, the impedance of CC2 will become insignificant (remember, the capacity value of CC2 is 10 times higher than CC1), effectively connecting CC1 to the collector of Q2. At this point, the collector of Q2 is also loaded by R_p , but this effect should be insignificant. For any further increases in signal frequency, the VA will now revert back to a 6-dB/octave open-loop gain rolloff until the open-loop gain drops below unity. The unity gain fre-

quency will be exactly the same as if CC1 had been used for simple single-pole compensation.

Figure 5.2 illustrates a graphical representation of the action of two-pole compensation.

Note: The slope angles have been exaggerated for clarity of illustration.

As shown, the low-frequency open-loop gain remains flat from 0 to about 100 Hz, designated as point P1. The slope line extending from P1 to point Z illustrates the 6-dB/octave open-loop gain rolloff of a typical single-pole compensation method. Point Z represents the frequency at which the open-loop gain drops below unity. When two-pole compensation is utilized, the flat region of open-loop gain is extended from point P1 to X, or from about 100 Hz to around 20 kHz. From point X to point Y, the open-loop gain rolloff is modified by two-pole response to decrease by 12 dB per octave. At point Y, the impedance of CC2 [Figure 5.1(h)] has become negligible, and the two-pole compensation circuit reverts back to a single-pole response. Note that point Z remains unchanged regardless of what type of compensation method is employed.

I generally like to be a little conservative in the use of two-pole compensation. Power amplifiers operating in the real world are sometimes required to provide herculean load demands as well as cope with abrupt changes in impedance and reactive conditions. It is impossible to test an amplifier under every real-world output condition, so I think it prudent to leave a practical margin of safety against instability problems. Therefore, I typically try to establish the open-loop rolloff point at about 10 kHz.

As a point of interest, it should be noted that at point X, where the open-loop gain begins to roll off (Figure 5.2), a prominent peak in open-loop gain will occur. This response is a result of the phase shift of CC2 and R_p , combined with the additional phase shift of CC1,

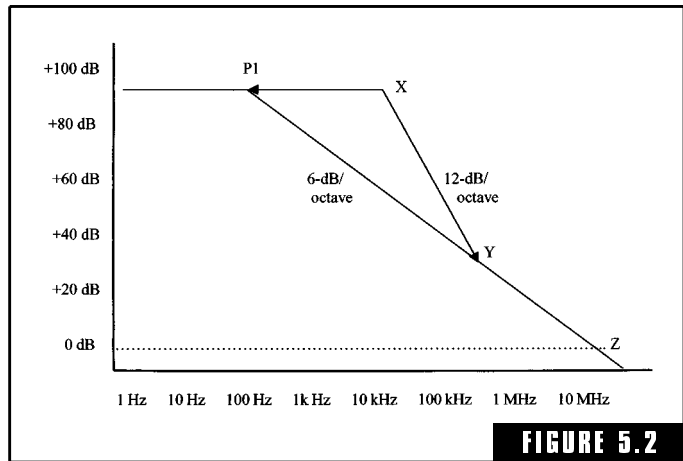

FIGURE 5.2
Open-loop gain response utilizing two-pole compensation.

resulting in a small percentage of positive feedback applied to the base of Q1. If you can visualize another capacitor-resistor network placed in series with CC1 and CC2, you would have a textbook example of a phase-shift oscillator! Admittedly, this is a scary situation, but in actual practice, the global NFB peaks simultaneously and negates the effect. In fact, harmonic distortion analysis shows a corresponding dip at this same point, so the ultimate outcome is an improvement in the THD performance.

Although I have not pursued this phenomenon any further, it seems reasonable that the peaking of open-loop gain in a two-pole compensation network could be targeted toward a specifically nasty problem with beneficial results. Perhaps, this may be an area for some future experimentation.

Although a little off the subject, allow me to use Figure 5.2 to expose another myth of Audiotropolis. (Audiotropolis is similar to the land of Oz, with the exception that it contains more fantasy.) There has been a lot of hype in audio circles regarding the nebulous concept of “open-loop gain bandwidth.” The “open-loop bandwidth” of Figure 5.2 (representative of some hypothetical amplifier) would be about 200 Hz (that is, 3 dB down from the P1 frequency). Imagine decreasing the open-loop gain by extending a horizontal line from the +40 dB point on the vertical axis until it intersected the 6-dB/octave slope line. The frequency of intersection will be about 100 kHz. If the hypothetical amplifier represented by Figure 5.2 exhibited a poor open-loop gain factor of +40 dB, it could easily have an “open-loop bandwidth” of 100 kHz and maintain the exact same stability characteristics. It would most certainly have inferior distortion performance throughout the audio bandwidth due to the low gain and resultant low global NFB values. However, an “open-loop bandwidth” specification of 100 kHz sure sounds better than 200 Hz on a sales brochure. The point is, an amplifier exhibiting high gain with a low open-loop bandwidth can be far superior in every performance aspect than an amplifier boasting a much higher open-loop bandwidth.

Optimizing the VA Stage

Regarding basic VA performance, the Darlington topology [as illustrated in Figure 5.1(c)] is difficult to surpass. It has the advantages of

high-gain and high current sinking-sourcing action, greatly improved by the incorporation of the current source as an active load. Instability problems are a virtual impossibility since the local NFB through CC loops the entire circuit. Nevertheless, there are a few ways that the basic circuit of Figure 5.1(c) can be enhanced.

Figure 5.3 illustrates several modifications that can be added to the basic Darlington VA for improved performance. The first of these, two-pole compensation, is incorporated by adding CC2 and R_p to the basic design. CC1, CC2, and R_p are typical values, and the entire circuit of Figure 5.3 is a good real-world design. In the previous discussion of two-pole compensation, I provided a rule-of-thumb determination for the value of CC2 as being about 10 times the value of CC1 (that is, CC1 is the same value as would be used for standard single-pole compensation). If you want to squeeze all of the benefits possible from the global NFB loop, you can decrease CC2 down to a minimum of 5 times the value of CC1. In the case of Figure 5.3, I have chosen a good middle-of-the-road compromise.

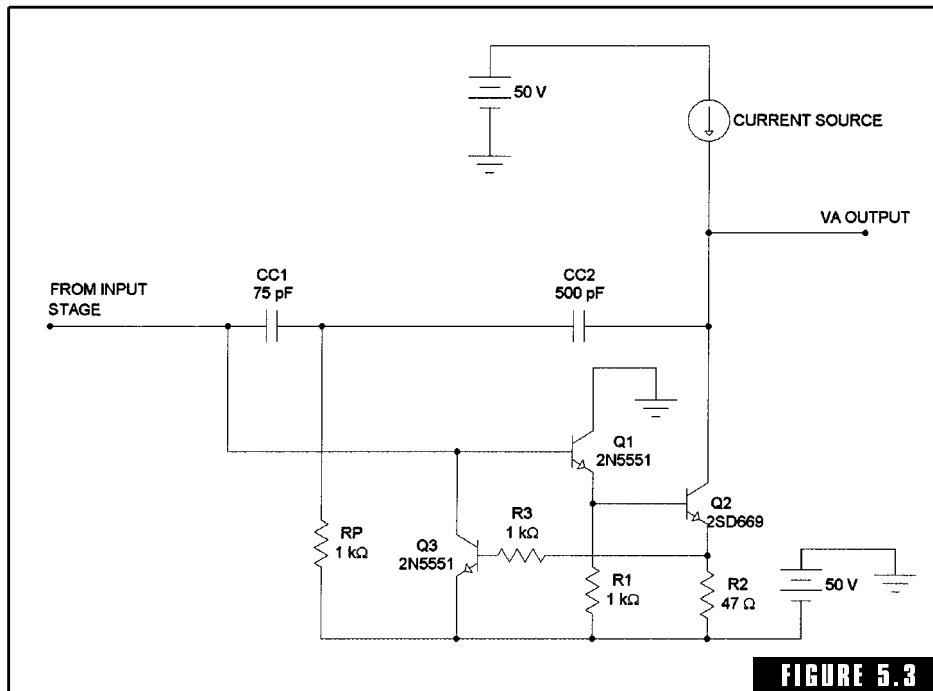

FIGURE 5.3

VA stage enhanced with two-pole compensation and current limit protection.

Q3, R3, and R2 comprise a *current limiting circuit*. VA current limiting will not improve any performance parameter of the VA stage, but it is critical to incorporating short-circuit protection in the OPS. As will be discussed in the next chapter, virtually all forms of OPS short-circuit designs protect the OPS by shorting the output signal from the VA stage to the output rail. During positive half-cycles, this isn't a problem because the constant current source is already current stabilized. However, during the negative half-cycles, a short-circuited condition from the collector of Q2 to the output rail will almost certainly "blow" Q2.

Note: Obviously, if the topology were reversed, with the current source being fed by the negative rail and the VA on the positive rail, the conditions would be reversed.

Therefore, a method is needed to limit the maximum current flow through Q2 during the times of OPS short-circuit activation.

R2 is used to sense the current flow through the emitter of Q2. When the voltage across R2 becomes excessive, indicating excessive current flow through Q2's collector, base current will begin to flow through Q3. This saturates Q3, diverting base current away from Q1 and Q2, and limiting Q2's maximum collector current to about 15 to 20 mA. During normal operation, the current limit protection will have no effect upon VA performance.

Figure 5.4 illustrates an enhanced VA stage for a true audiophile-quality high-power amplifier. In theory, this VA could be driven from the differential outputs of a single differential input stage. In actual practice, unfortunately, this approach is rather pointless. To obtain the practical benefits of this VA topology, it must be used in conjunction with a mirror-image input stage.

The first step in understanding the operation of Figure 5.4 is to recognize that it consists of two complementary circuits. Q1, Q2, Q3, Q4, and their associative circuitry make up the top complementary VA circuit. Obviously, the remaining four transistors and the associative circuitry make up the bottom complementary VA. Since the operation of both circuits is identical, we need discuss the operation of only one to understand the other.

For the sake of convenience, the functional description of the bottom circuit will be explained since it is very similar in illustrative

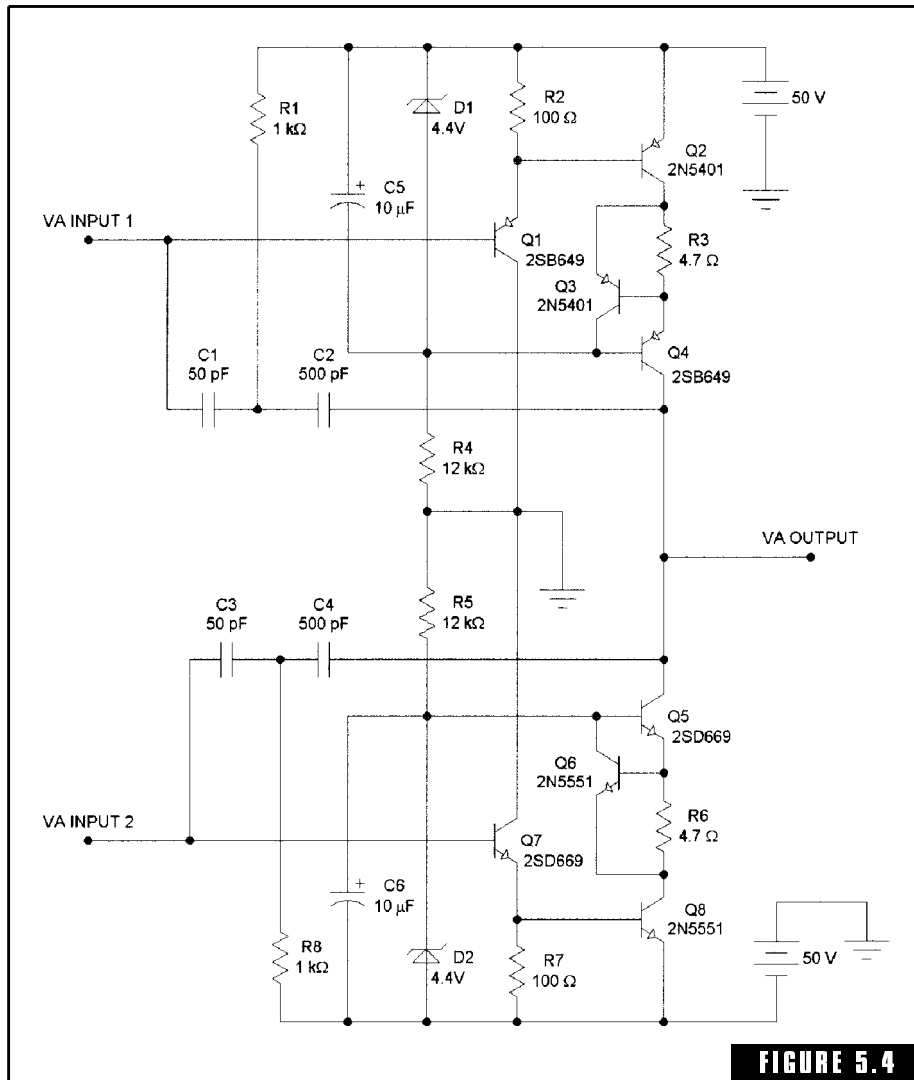

FIGURE 5.4

Enhanced push-pull VA stage for use with a mirror-image input stage.

orientation to Figure 5.3. A comparison of Figure 5.3 and the bottom circuit of Figure 5.4 will reveal the addition of a cascode stage (that is, Q5 in Figure 5.4). It is necessary to add a cascode stage in this type of complementary design because the output of a Darlington stage does not make a very good active load for its counterpart. A complementary Darlington VA can be utilized without a cascode stage if it is

driving a BJT OPS with a compatible input impedance. I believe this to be an inferior approach, however.

The incorporation of cascode stages in a complementary VA design provides a good active load for maximum gain utilization, improved slew rate (that is, VA sourcing improves), improved DC stabilization at the VA output, and the PSRR at the VA output goes through the roof! Note that the VA output node is, for all practical purposes, totally isolated from both power supply rails by the two cascode stages.

Referring to Figure 5.4, the cascode transistor Q5 is biased by a simple zener voltage regulator consisting of R5 and D2. C8 is simply a filter capacitor to help stabilize the voltage across D2. Q7, Q8, and R7 make up the basic Darlington VA as discussed previously. Q6 and R6 form the current limit protection. Note that I moved its position to protect the cascode transistor Q5 rather than Q8 (see Figure 5.3). This modification improves the low-impedance characteristic of the VA input, eliminating the need to place a resistor in Q8's emitter leg. Finally, C3, C4, and R8 make up the two-pole compensation network.

In sum, each of the complementary VA circuits of Figure 5.4 incorporate two-pole compensation, current limit protection, active loading, and high gain (i.e., beta enhancement). These characteristics are close to ideal for the specific requirements of a VA stage design.

Modern VA Stage Designs

The purpose of this section is to illustrate how VA stages are typically used in conjunction with various input stage designs. In keeping with the most common methodology, we will start with the mediocre and progress toward the high end. All of the following circuits are functional as illustrated. They can be constructed, tested, and experimented on, if desired. The global NFB circuits incorporated are typical with the design type, and the compensation networks should provide stable operation when utilized with typical OPS designs. I also felt it appropriate to start including noise specifications with each design type. These specifications are typical and represent a real-world expectation value. They are based on the assumption that a good OPS design will be incorporated and optimum construction methods for the reduction of hum are followed (hum is typically considered part of the noise spectra).

Figure 5.5 illustrates a differential VA stage merged with a JFET cascode input stage. In terms of audio excellence, there is little that can be said in favor of this design—it appears to have almost everything against it. But, in reality, I like to use it for small to medium musical instrument amplifiers. Its strong point in this regard is

QUICK TIP
If you have any intentions of utilizing this design for musical instrument amplifier applications, additional input protection circuitry should be incorporated as detailed within the section entitled “Input Signal Conditioning Circuits” of Chapter 4.

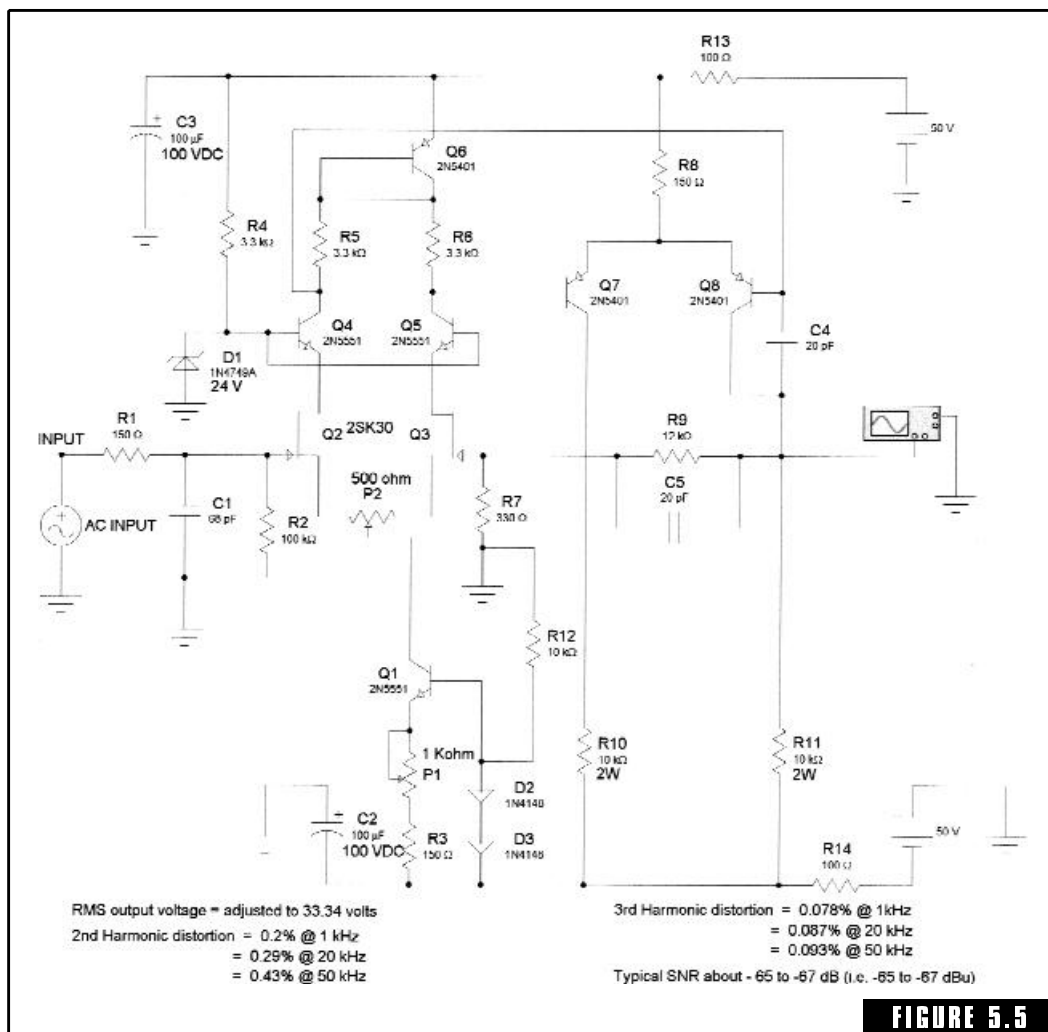

FIGURE 5.5

Differential VA stage used with JFET input stage.

the electrical isolation of the input, which presents a special type of immunity against the abuse of plugging guitar cords into and out of the input jacks with full power applied to the amplifier.

In the seventies and eighties, the design of Figure 5.5 was certainly classified as hi-fi. By today's standards, this might be rather ambiguous. As shown by its performance specifications, there is much room for improvement, and the OPS distortion will most assuredly *not* swamp the small-signal distortion (a common misconception of times past). This design type is still commercially sold, usually advertised as a "JFET cascode input" amplifier, the insinuation being that the cascode input stage will greatly improve linearity. This is false. The cascode stage keeps only the maximum VDS parameter of the JFETs from being exceeded.

Most of the functional details of the Figure 5.5 topology have already been discussed, but a few unique aspects can be touched on. R1 and C1 form a low-pass filter to reduce certain types of high-frequency interference that could find their way into the amplifier. R8, Q7, Q8, C4, R10, and R11 make up the differential (sometimes referred to as a *balanced*) VA stage. C4 is the dominant-pole capacitor, or CC. Note the low-capacity value of C4, indicating the low open-loop gain (resultant of the low *gm* of the input stage) of this design. Poor open-loop gain in this case is a combination of utilizing JFETs for the input stage and the complete absence of any active load techniques.

The transistor-diode of Q6 (note the collector and base are tied together) is a poor method of trying to match the Vbe characteristics of Q7 and Q8 so that, in theory, the voltage drop across R8 will equal the voltage drops across R5 and R6. In reality, the balance of the JFET differential stage will be so poor that the voltage drop across R8 will be an average of the voltage differences. This provides the surprising reaction through the global NFB loop of helping to cure much of the problem. The end result is a neat little circuit that performs much better than one would expect at first glance. However, *SPICE 3* simulation indicates that performance would be identical if Q6 were replaced with a standard 1N4148 diode.

The action of the variable constant current source, made up of Q1, P1, R3, R12, D2, and D3, is also unique. As P1 is adjusted back and forth, the combined effects of the poor JFET matching characteristics with the DC error correction (i.e., the DC global NFB) applied to the

gate of Q3, will cause a DC balance between the collectors of Q7 and Q8 at some specific setting of P1. A balance of the VA differential stage (that is, Q7 and Q8) must be obtained to facilitate the optimum voltage swing at the VA output (the VA output is the point where the little oscilloscope icon is connected). Adjustment of P1 can usually obtain a VA balance, but in some cases, the JFETs must be switched around or replaced with one or two other random choices.

Even if a DC balance of the VA can be obtained, this does not mean the balance will automatically occur close to the circuit common potential. P2 is incorporated to compensate for this problem. Once the VA is DC balanced, P2 is adjusted to try to achieve a low DC offset at the output. This adjustment is interactive with the previous P1 adjustment, so when a low DC offset at the output is reached, the P1 adjustment is repeated. This procedure continues as many times as necessary to achieve a simultaneous VA balance and low DC offset. When completed, the mismatching of all active components has been pseudo-compensated for (i.e., only in reference to DC balance), and the complete circuit is reasonably stable.

R13 and C3 make up an older type of power supply decoupling network. A large percentage of rapid power supply fluctuations will be dropped across R13 while being filtered by C3 (that is, R13 and C3 comprise a low-pass filter). This helps to compensate for the poor PSRR of the circuit in Figure 5.5. In the modern designs we will examine shortly, this type of decoupling is completely unnecessary. R14 and C2 perform the identical function for the negative power supply rail.

The specifications for the circuit design of Figure 5.5 are included in the illustration. I thought it rather pointless to include the distortion graphs since they are virtually identical to the distortion curves provided for the circuit of Figure 4.9(a) of the previous chapter.

Figure 5.6(a) definitely brings us into the realm of high-end audiophile-quality performance. This is immediately evident from the performance specifications included in the illustration. To put it candidly, the distortion performance of an amplifier utilizing this type of input and VA design will be totally dominated by the OPS

QUICK TIP
Obviously, if you have a transistor/FET analyzer of some sort, the trouble of trial-and-error matching of transistors or FETs can be eliminated. I use a Sencore Super Cricket for this purpose.

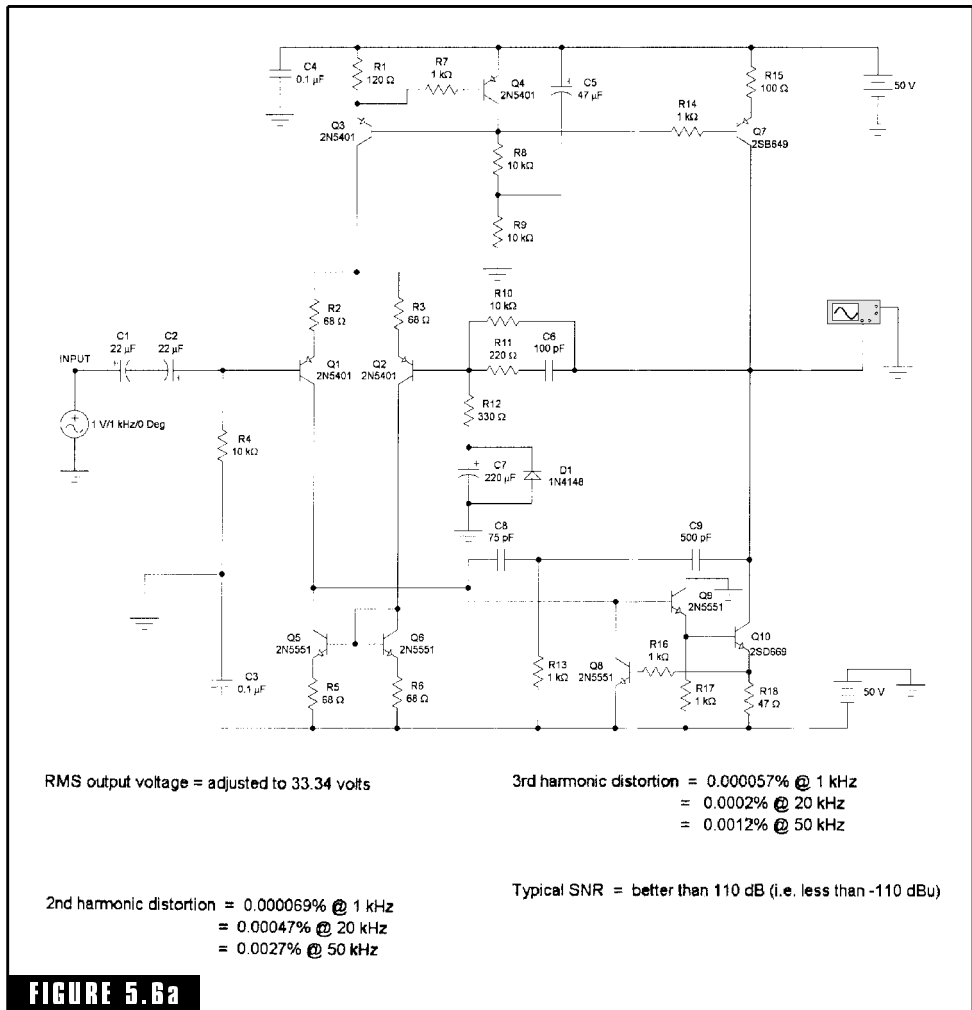

High-performance input and VA stage design.

distortion (primarily crossover distortion and large-signal nonlinearities). These issues will be addressed in the next chapter.

The associated distortion graphs for Figure 5.6(b) illustrate the ideal type of response we desire for an audio power amplifier. The second harmonic distortion curve shows the P1 point has been moved from about 200 Hz to around 1 kHz through the use of two-pole compensation. Therefore, we can say that the open-loop bandwidth has been increased from 200 Hz to 1 kHz without any accompanying loss

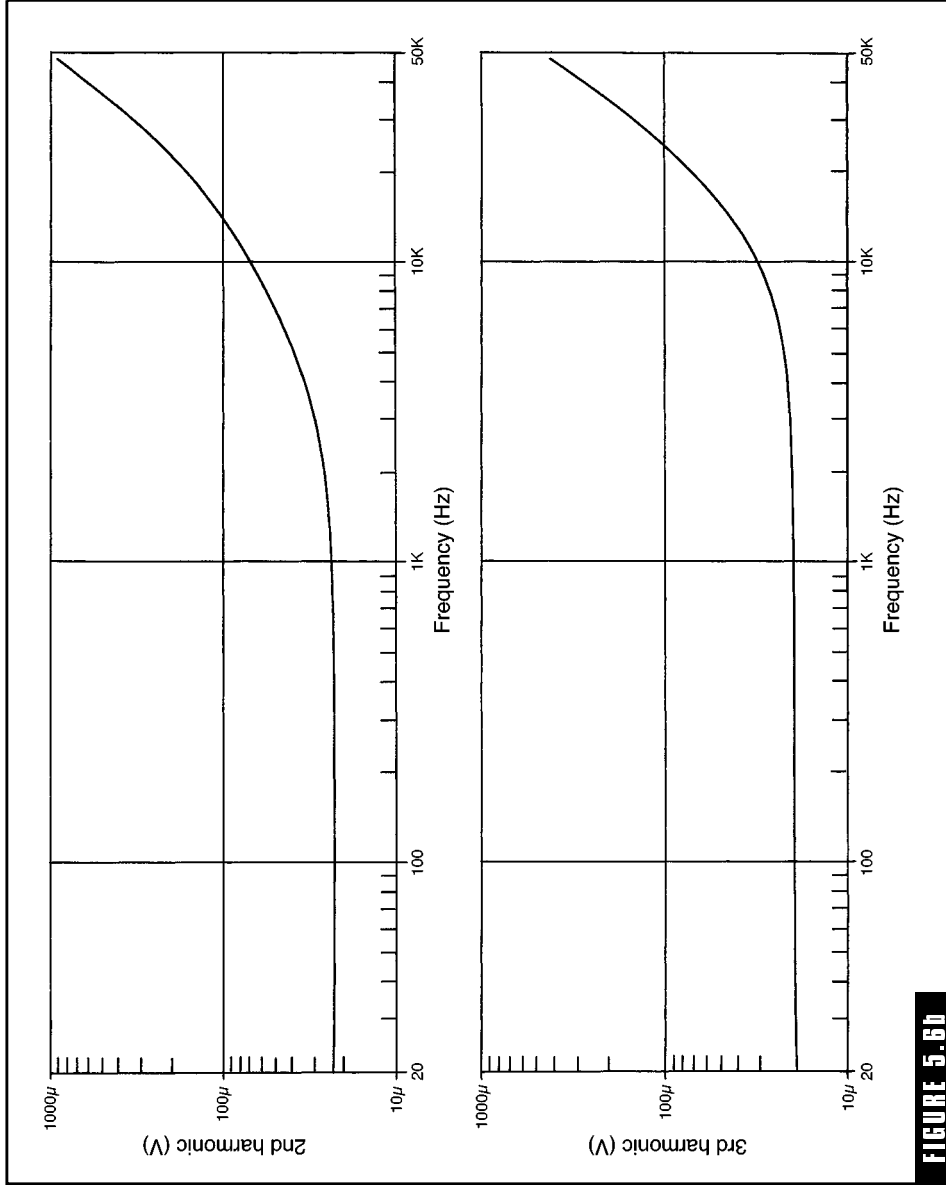

FIGURE 5.60

A graphical illustration of the excellent distortion performance of the input and VA stage combination in Figure 5.6(a).

of stability. A summation of both distortion curves would indicate an open-loop gain rolloff of about 12 dB per octave above P1.

The VA of Figure 5.6(a) is the Darlington topology with current limiting provided by Q8, R16, and R18. The need to place a current-sensing resistor in the emitter leg of Q10 is undesirable, but it adds so little to the extremely low distortion inherent to the design that it can be considered negligible. Two-pole compensation is accomplished by C8, C9, and R13. The capacity values of C8 and C9 could be lowered slightly for improved high-frequency distortion performance, but I believe the added security against instability is well worth the insignificant increase in high-frequency distortion.

The constant current source for the input differential tail current is provided by Q3, Q4, R1, R7, R8, R9, and C5. This current source design is illustrated in Figure 4.3 of the previous chapter, together with an accompanying discussion of its operation. Note how the constant current source for the VA, consisting of R14, R15, and Q7, utilizes the voltage reference (i.e., the collector of Q4) of the differential tail current source.

The output DC offset voltage of the circuit illustrated in Figure 5.6(a) came out to a very respectable 20.83 mV. The input DC offset voltage was a little on the high side, measuring about 160 mV. Neither of these offsets should be of any practical concern. Methods of reducing offsets were discussed in Chapter 4. The important point is that excellent (even exceptional) operational performance is automatic without the use of trim pots or servocircuits. This is certainly a major advantage of this circuit topology.

The input and VA stage of Figure 5.6(a) does have a few minor shortcomings. First, the slew rate is asymmetrical and even a little sluggish in rise time. This characteristic should not have any effect whatsoever upon amplifier designs up to 200 watts RMS. However, when we get into higher power levels, a definite need for improvement arises. I like to have a symmetrical slew rate of about 40 V/ μ s for amplifiers in the 300- to 500-watt power ranges, precluding any possibility of suspicion toward slewing distortion. Another minor criticism of Figure 5.6(a) is its inherent tendency toward some clipping asymmetry. Typically, there is about a 1-volt difference in clipping level, due to asymmetries of voltage drop across Q10 and R18 (with Q10 saturated) versus the voltage drop across Q7 and R15 (with Q10 cutoff). A third minor criticism,

as previously stated, is the need to place a current-sensing resistor in the emitter leg of Q10. A fourth criticism, as mentioned in the previous paragraph, is the approximate 1/10-volt DC offset at the input.

If you think the previous criticisms sound a lot like nitpicking, you're absolutely right. Only a few years back, most design engineers would have thought it ridiculous to strive toward the performance levels obtainable in the circuit of Figure 5.6(a). For all practical purposes and typical power levels, Figure 5.6(a) is virtually ideal. However, the audio field is richly integrated with the arts, and audio electronics is a kind of pseudo-artform within itself. This fact is vividly demonstrated in the aesthetics of gold-plated enclosure design, expensive woods utilized in speaker construction, and intricately detailed electronic construction. I know of audiophiles who go to the trouble and expense of having their control knobs custom machined! The point is, there does not have to be a utilitarian or practical purpose behind everything we enjoy. Perfection will never be achieved in the audio fields, and it's well that it cannot be. If you want to build your own audiophile-quality 200-watt RMS audio power amplifier, you need look no further than the input and VA design of Figure 5.6(a). If you want to progress to something bigger and better, the following designs should be of interest.

Figure 5.7(a) illustrates a mirror-image input stage feeding a complementary VA utilizing complementary cascode stages for active loading. This circuit is actually a step down from the performance characteristics of Figure 5.6(a), but I wanted to include it at this point as a bridge to understanding the next circuit design. The circuit of Figure 5.7(a) is typically used in professional audio systems, especially high-power public address amplifiers.

There are two divisions of consumers who purchase audio equipment under the broad and poorly defined classification of "professional audio." One division, representing the broadest marketplace, consists of local (i.e., semiprofessional) entertainers and church organizations that routinely purchase public address amplifiers, musical instrument amplifiers, speakers, microphones, and other such equipment. This same "professional audio" equipment is often purchased by private individuals for home use, but it remains in the classification of professional audio. Generally speaking, the groups or individuals buying this type of "professional audio" equipment are not audiophiles, and they are usually not well informed regarding the technicalities of

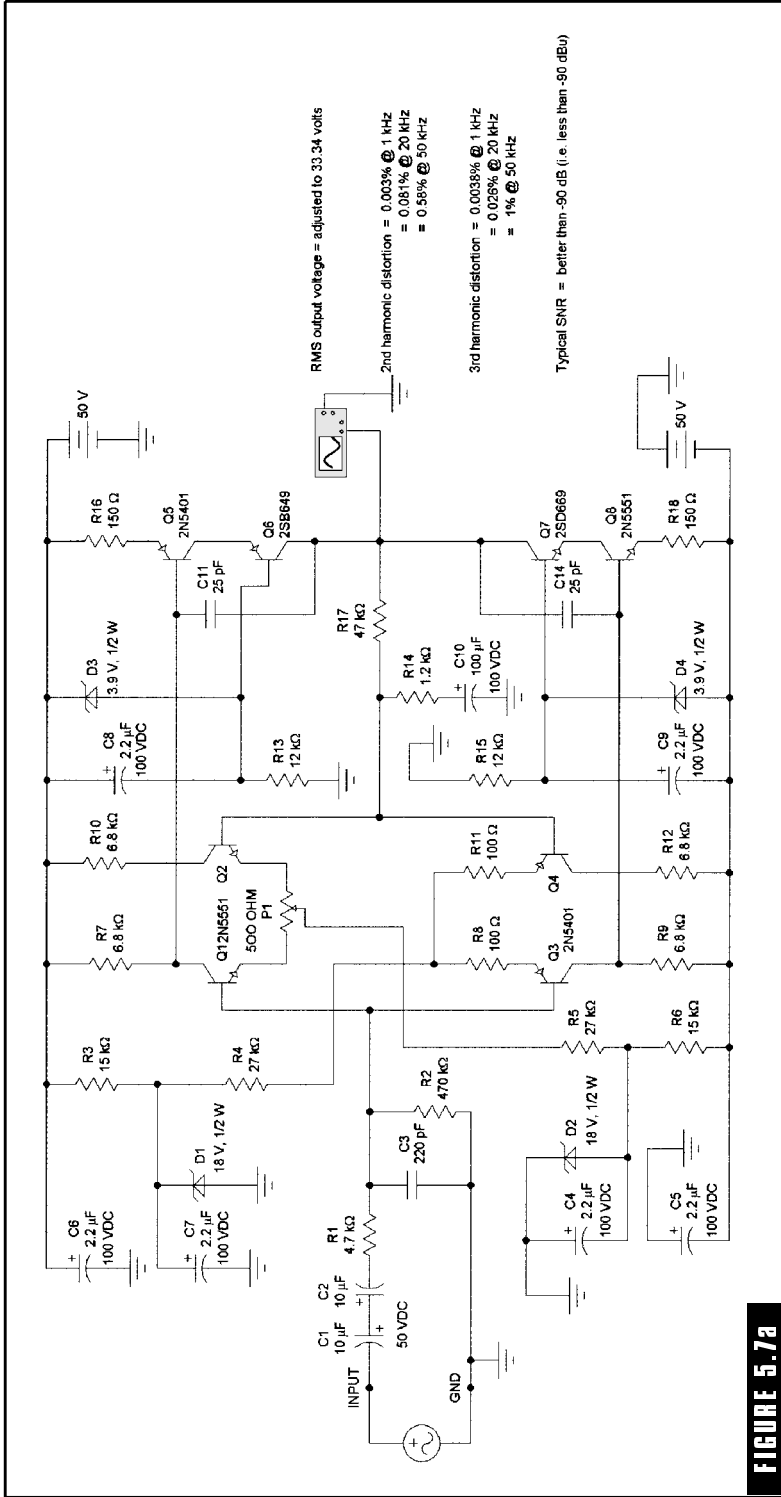

FIGURE 5.7a

Mirror-image input stage feeding a complementary VA with active loading.

sonic performance. Consequently, commercial manufacturers targeting this marketplace are more concerned with power and reliability than sonic quality.

The other consumer division is made up of audio professionals working in recording studios, broadcast stations, or on the road as full-time professional entertainers. These individuals cannot afford to accept less than the best; they are well educated in audio technology, and sonic quality is a paramount issue.

The circuit topology of Figure 5.7(*a*) fits into the broad segment of professional audio. Much improvement can be made in reference to sonic quality, but it has some advantages over the circuit of Figure 5.6(*a*) in terms of working well with high-power public address amplifiers and musical instrument amplifiers.

The strong points of Figure 5.7(*a*) are its symmetrical clipping (very important to public address amplifiers incorporating anticlip circuitry), good PSRR, and symmetrical slew rate within the audio range. (The slew rate is not improved over the circuit of Figure 5.6(*a*), but it is forced to be symmetrical.) Figure 5.7(*a*) uses fewer active components than the circuit of Figure 5.6(*a*) (of great concern to manufacturers), and it is very reliable. The noise-canceling benefits of a mirror-image input topology are evident because even though the input impedance is quite high, the typical SNR specifications are typically better than -90 dB. The output impedance of the VA is rather high (a little greater than 1 k Ω), caused primarily by the low beta of Q5 and Q8 and the series resistance presented by R16 and R18. This is not the best of conditions for driving nonlinear BJT output transistors, but it is more or less irrelevant when providing the drive voltage to MOSFET devices. It also provides the benefit of not having to provide any type of current limit protection within the VA since the internal impedance automatically limits excessive VA currents. Of course, this benefit provides another cost savings to manufacturers.

The circuit of Figure 5.7(*a*) is very similar to the circuit of Figure 4.10(*a*) of the previous chapter, so I will try not to repeat the basic operations. However, there are a few differences that bear mentioning. First, the active constant current sources for providing tail current in Figure 4.10(*a*) have been replaced with less expensive pseudo-constant current sources (R3, C7, D1, and R4 for the lower differential circuit—R6, C4, D2, and R5 for the upper differential circuit). Also, the differential current mirrors of Figure 4.10(*a*)

have been replaced by resistors (R7, R9, R10, and R12). These modifications are basically cost-cutting measures. The complementary Darlington VA of Figure 4.10(a) has been converted to a complementary cascode VA in Figure 5.7(a). As I stated earlier, one complementary Darlington VA does not make a good collector load for its counterpart. The incorporation of two cascode stages in Figure 5.7(a)'s VA provides good active loading for Q5 and Q8 and greatly improves DC stability at the VA output. Unfortunately, the beta-enhancing characteristics of the Darlington topology have been forfeited in the process.

While it is true that a mirror-image topology will handle these degradations in a more graceful manner than a single differential input stage, there is still a considerable loss of performance in the areas of PSRR, input stage transconductance, distortion, noise, and slew rate. The loss of input gm and automatic differential stage balance also mandates the use of a balance trimpot P1. From a personal viewpoint, I could do without the use of any trimpots in a power amplifier!

The topology of Figure 5.7(a) is especially suited for driving MOSFET OPSs in the 300- to 400-watt RMS power range. In comparison to the most popular commercially available professional audio power amplifiers, this topology is significantly superior in performance. When combined with a well-designed MOSFET OPS, it is reasonable to expect THD performance at full output to be in the 0.1 percent range at 1 kHz into a 4-ohm load. This is about 10 times better than the most popular 800 series (that is, 400 watts per channel) professional audio power amplifiers on the market today.

It could be argued (and I'm sure it will be) that the distortion performance of Figure 5.7(a) disqualifies it from being considered in the audiophile category. I combined this input and VA stage topology with two variations of source follower OPS designs (i.e., the 250 MOSFET and 550 FET cookbook designs detailed in Chapter 11), and I can state that the distortion performance of these completed amplifiers is about 10 to 20 times better than many audiophile vacuum tube amplifiers in the \$2000 range. From a personal perspective, I think the 250 MOSFET design sounds great in both domestic hi-fi and public address applications. In consideration of the distortion curves and Fourier analysis, I do not believe that any distortion content is perceptible to the human ear, but the human mind is another thing!

The distortion curves for Figure 5.7(a) were taken with a 10-k Ω load placed on the VA output. This is reasonable and as can be seen

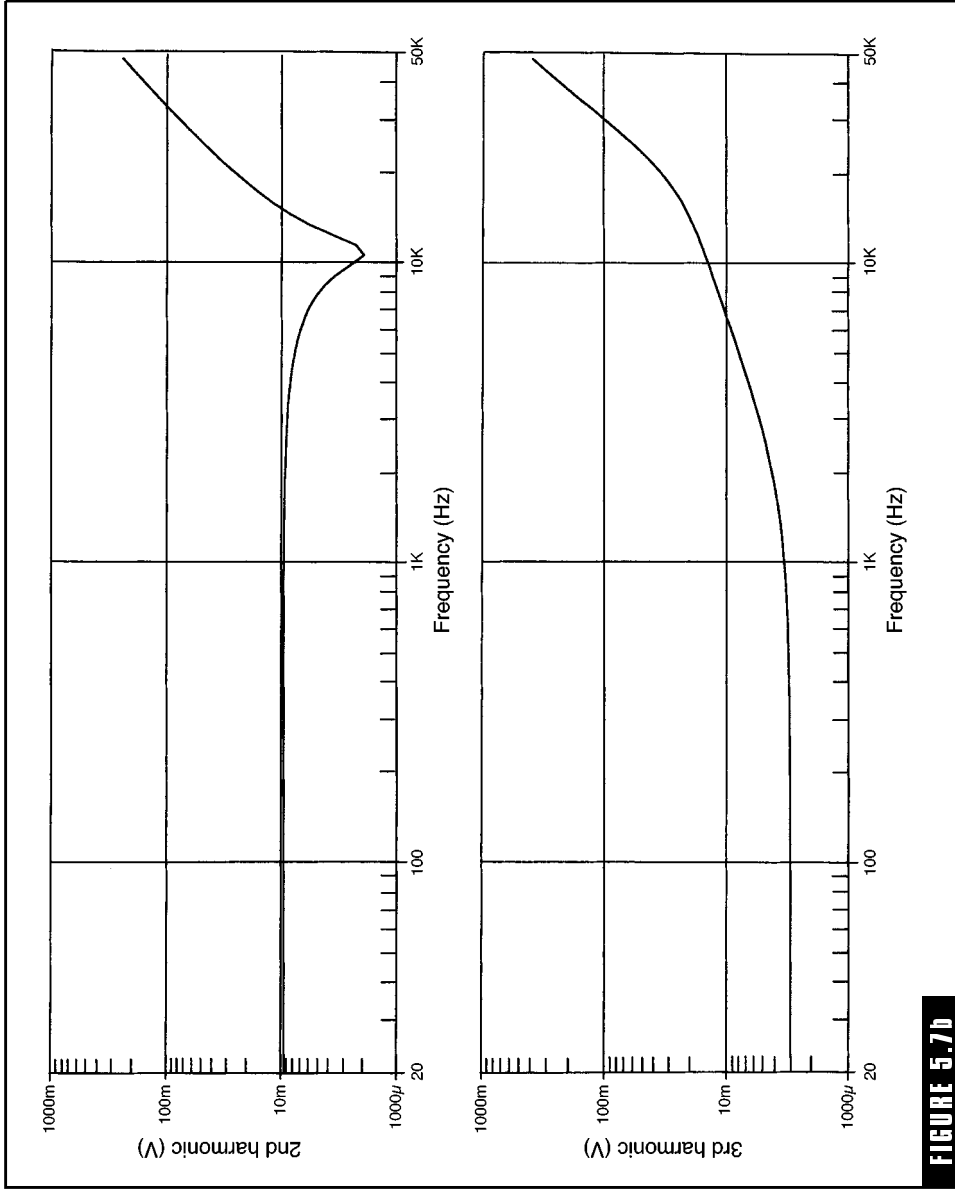

FIGURE 5.7b

The distortion performance of the mirror-image topology of the circuit in Figure 5.7(a).

from the graphs, the overall distortion increased by about 10 percent. The second harmonic distortion curve indicates that the P1 point is pushed way up on the audio frequency band (about 10 kHz), due to the low open-loop gain. The third harmonic distortion curve shows clear signs of current starving beginning at about 20 kHz. Of course, this condition could be greatly improved by utilizing active constant current sources for the tail supplies and current mirrors for the differential collector loads.

Figure 5.8(a) illustrates an ultrahigh performance input and VA stage combination incorporating all of the best enhancement techniques covered thus far. As detailed in the illustration, the performance specifications are literally outstanding!

As shown, the complete input and VA stages consist of two differential input amplifiers and two beta-enhanced (that is, Darlington) VA stages with two-pole compensation, current limiting, and cascode loading. The dual circuits of each stage are arranged in a complementary fashion; hence, the upper stages are a mirror image of the bottom stages. For the sake of clarity, I will describe only the functions of the upper stages (i.e., the stages predominantly connected to the positive power supply rail) since the operation of the bottom stages will be identical (but complementary).

Q7 and Q8, together with their associated degeneration resistors, R2 and R1, make up the current mirror for the differential input pair consisting of Q1 and Q2. R3 and R4 are degeneration resistors for Q1 and Q2. Tail current for the differential input pair (Q1 and Q2) is provided by the constant current source made up of Q9, R10, D1, D2, C5, and R13 (R13 is a shared current limiting resistor for the other constant current source). C4 is a decoupling capacitor for the positive rail voltage.

C1 and C2 make up a nonpolarized capacitor for input signal coupling. If you really want to go first class, you may want to use a 10- μ F metalized polypropylene capacitor in their place. R9 essentially establishes the input impedance. It must equal the value of R15 (or vice versa) for accurate DC balance. The closed-loop voltage gain is mainly determined by the ratio of R12 and R15. The global NFB network consists of R15, C10, R16, R12, and C6. Diode D3 is a protection diode to protect C6 from erroneously being reverse-biased in the event of a drastic DC imbalance at the output.

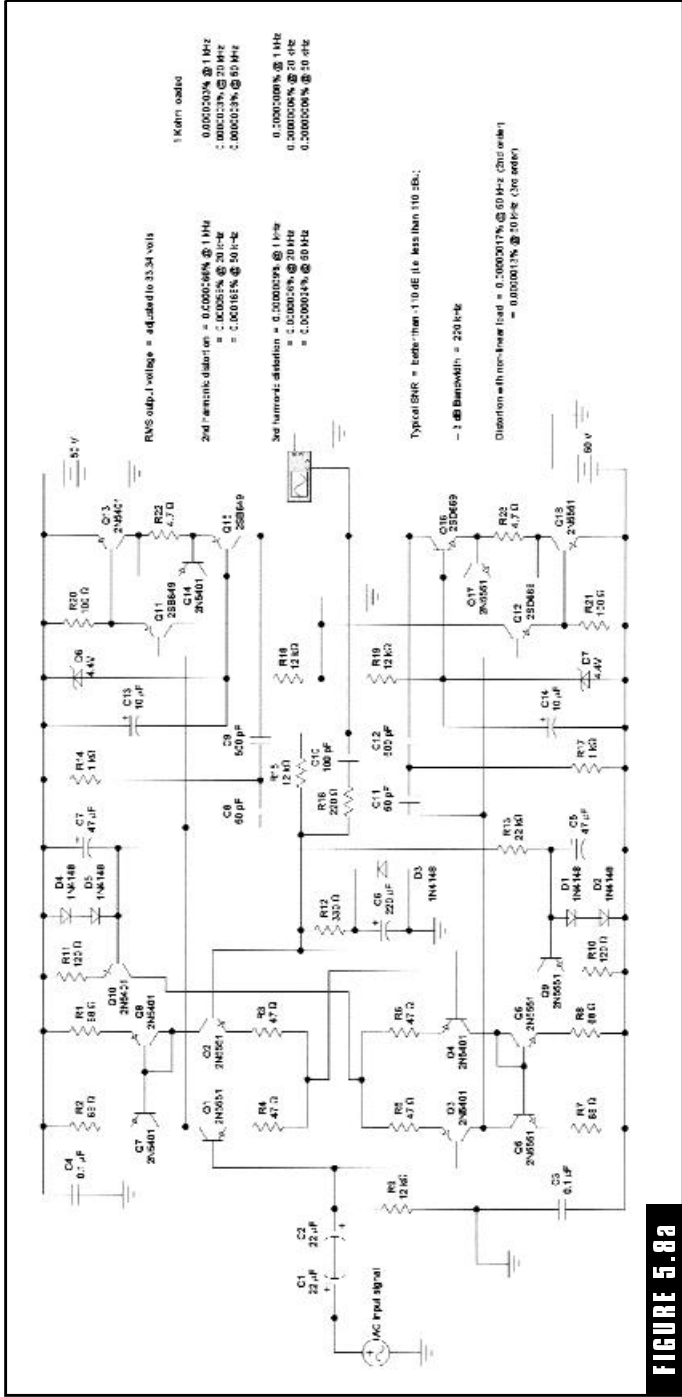

FIGURE 5.8a

Ultra-high performance input stage and VA stage combination.

Q11, Q13, and R20 make up the upper Darlington VA. R18, D6, C13, and Q15 comprise the cascode collector load for Q13. The VA current limit protection is provided by Q14 and R22. Note that I moved the current limit protection into the emitter leg of Q15, maintaining the low-impedance input of the Darlington stage. As I stated previously, it is desirable to keep the input impedance of a transimpedance amplifier (that is, the VA) as low as possible. Finally, C9, R14, and C8 make up the two-pole compensation network.

In addition to the standard tests performed on the previous designs, I added a few additional tests to demonstrate the excellent characteristics of this topology. The first test, loading the VA output with a 1-k Ω resistor, actually improved the distortion curves (compare this to the approximate 10 percent increase in distortion of the previous design when loaded with a 10-k Ω resistor). I also made up a nonlinear load by connecting two 1N4148 diodes, each in series with a 470-ohm resistor, from the VA output to circuit common. The diodes were connected in opposing polarities, providing a good simulation of the VA output driving two BJT predrivers. The maximum second- and third-order distortion specifications for the nonlinear load are provided in the illustration.

As a test of Figure 5.8(a)'s PSRR, I placed a 10-volt RMS, 60-Hz AC power line signal in series with the positive 50-volt DC power supply [Figure 5.8(a)]. This resulted in only 12 mV of 60 Hz AC on the VA output. And finally, I offset the DC voltages of the rail power supplies; the +50 was reduced to +40, and the -50 was increased to -60. The nominal 104-mV VA DC offset (that's right, 104 mV!) increased to 802 mV. Needless to say, DC power supplies have to get pretty corrupted with line transients or ripple to significantly affect this topology.

Sometimes, experience is a good teacher. Whenever I construct a power amplifier using the topology of Figure 5.8(a), it is simply a delight to test for the first time (providing that I didn't make any goofs in assembly!). The waveshapes look ideal, clipping is perfectly symmetrical, slew rate is symmetrical, the signal frequency can be increased up to the maximum bandwidth without any funny wobbles or shakiness in the scope trace, and I don't have to adjust anything except the quiescent bias for the output transistors!

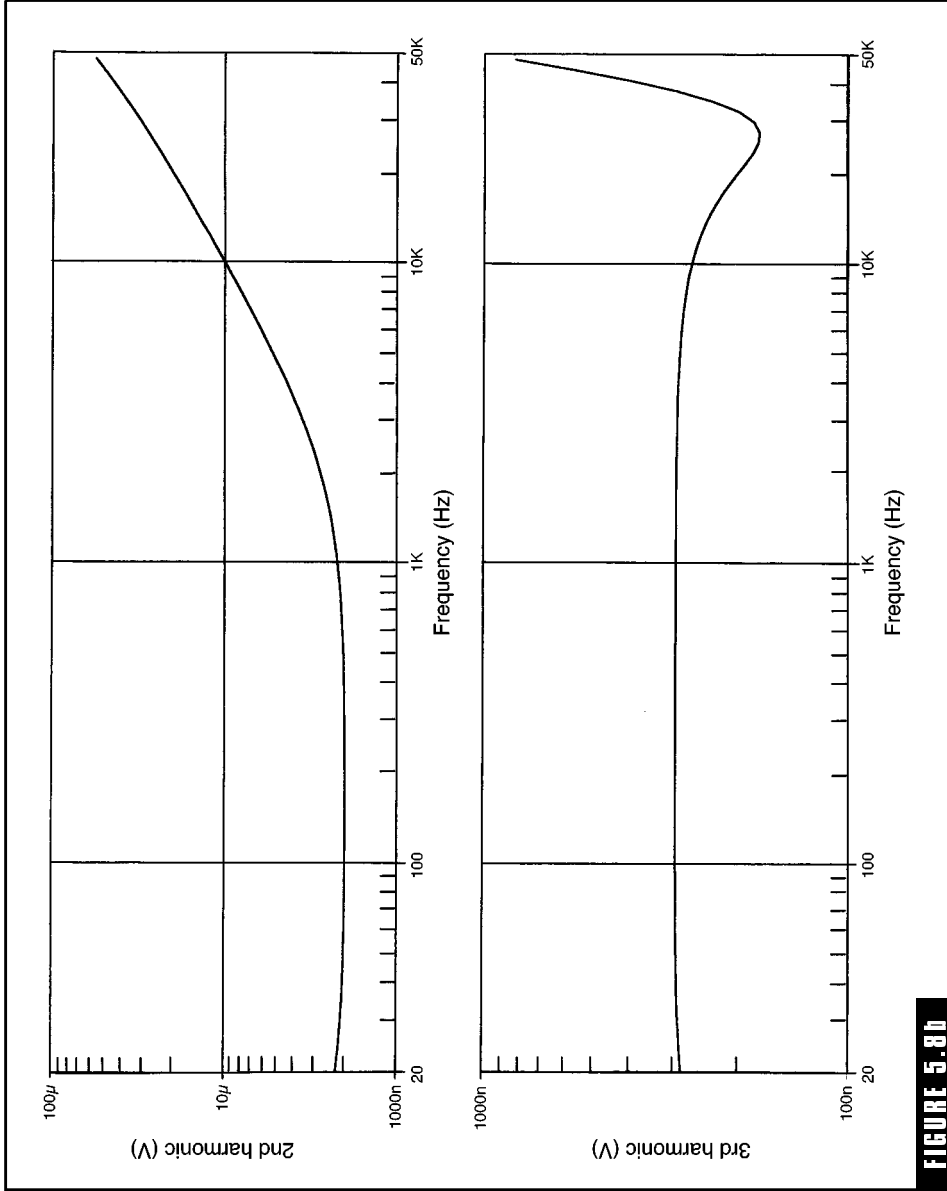

FIGURE 5.8b

A distortion graph illustrating the improved performance of the mirror-image topology of Figure 5.8(a).

Obviously, the topology of Figure 5.8(a) is more complex and expensive than other optional designs we have examined. However, if your goal is to construct a top-of-the-line, no-compromise audio amplifier, this topology will allow you to build one that is virtually unequalled on the commercial market—at any price!

Output Stages: Configurations, Classes, and Device Types

There is no question that the *output stage* (OPS) of a three-stage architecture presents the greatest obstacle in the pursuit of sonic perfection. There are many design choices, class types, and distortion mechanisms to consider when choosing the optimum topology. Each one of these topics could easily fill a very formidable book in itself, but fortunately for us, the winds of convention and experience have narrowed these subjects to a handful of practical application decisions. For convenience in discussion and analysis, this chapter will be divided into five subtopics: General Principles of Output Stages, Class A Designs, BJT Class B Output Stages, MOSFET Class B Output Stages, and IGBT Output Stages.

General Principles of Output Stages

Purpose and Function of the Output Stage

The purpose of the OPS is to receive the high-level output voltage from the VA stage and interface it to a low-impedance reactive load (i.e., a speaker system). In other words, the OPS is typically a unity voltage gain current amplifier. OPSs including voltage gain are not unheard of, but they are usually designed with the motivations of reducing the level of global NFB and/or increasing the open-loop bandwidth. This type of design methodology is somewhat defeatist and stems from the same old misconceptions of “linearize before applying global NFB” and “high levels of global NFB are bad.” If the VA stage can provide almost “distortionless” voltage amplification up to the “near” rail potentials (which we have proved it can), there is simply no practical reason to try to obtain further voltage gain in the OPS.

There are three primary distortion mechanisms inherent to OPS designs. These are (1) crossover distortion, (2) switching distortion, and (3) beta droop. These distortion mechanisms will be discussed thoroughly in the next chapter. For now, it is only important to be cognizant of their existence.

In addition to three major distortion mechanisms, there are the added complications of thermal stability and reliability. Even the most efficient OPSs get warm; most get hot. As a BJT becomes hot, its internal leakage currents will increase as its V_{be} parameter decreases. If strict measures are not maintained to thermally regulate quiescent current in BJT output devices, the power amplifier will go into destructive thermal runaway. None of the output devices, including the BJT and MOSFET, can be allowed to exceed certain maximum temperature parameters if any kind of reliability is hoped for. This provides the further complication of ensuring adequate thermal conductivity through the use of appropriate heatsinks.

Depending on the OPS class, additional complications may be involved. For example, a class B OPS will always suffer from crossover distortion, resulting from the nonconjugate V_{be} characteristics of complementary output devices. Each OPS class suffers from its own idiosyncratic problems. However, we can peel these onions down into simplified two-way decisions for the most part.

Output Stage Classes

For reasons that will eventually become apparent, it is important to recognize that the only difference between class A, class AB, and class B is the quiescent bias setting.

CLASS A

In a class A OPS, current flows continuously in all of the output devices throughout the entire signal cycle. In other words, the output bias is adjusted so that the signal current through each output device flows for the full 360 degrees of the signal.

Class A operation inherently eliminates two of the three major OPS distortion mechanisms, both of which relate to switching characteristics of solid-state devices. Since class A output devices are not forced to switch off during any portion of the signal cycle, switching distortions are not possible. However, on the down side, basic electronic theory dictates that the power dissipation of the output devices must be at least equal to the power dissipation of the load. In actual practice, considering the real-world inefficiencies involved, the actual efficiency is much less than this.

A class A OPS can be maximally efficient (i.e., approaching 50 percent) only when the signal level is at maximum. This is because the OPS dissipation must remain the same regardless of signal level, unless the rail voltages or the bias is adjusted. Various methods of improving class A efficiency have included methods of dynamically altering the bias or rail supplies (commonly referred to as *sliding bias* or *dynamic bias*), but these methods have not attained great acceptance. The concept is good, but the complications arising from trying to follow the extreme variations in musical transients result in a high level of dynamically varying transient distortion. This problem appears to be worse than the crossover and switching distortion that the class A topology was trying to avoid.

Assuming that all inefficiencies of transistor and passive devices could be done away with (allowing a hypothetical class A push-pull amplifier to approach a 50 percent efficiency at maximum signal

Originally, amplifier OPSs were divided into classes based on how they were biased and the percentage of the signal cycle flowing through the output devices. Later, this methodology evolved into classification on the basis of technique as well (class D, for example). Today, the major classes are divided on the basis of bias, current flow percentage, and technique, with some ambiguities involved with the more exotic classifications.



amplification), there would be severe distortion of all high-level musical transients. In other words, there would be no headroom for transients to utilize. They would simply be clipped. To facilitate the accurate processing of musical transients, the maximum signal level must be reduced by at least 50 percent (or much lower, according to the majority of esoterics), which means the efficiency drops to an exceedingly low level. In terms of typical real-world expectations (putting the inefficiencies of OPS devices back into consideration), a typical class A OPS may dissipate 240 watts RMS to deliver a maximum of 80 watts RMS to a speaker system. However, the nominal listening level must be lowered to at least 40 watts RMS to have any hope of processing the normal musical transients. The bottom-line result is an audio amplifier wasting 240 watts of power to process 40 watts of musical power. Even then, the transient distortion would probably be worse than typical levels of crossover distortion.

In simple terms, class A OPSs are not practical. This is especially true when we consider that modern class B amplifiers can easily achieve distortion levels below 0.01 percent throughout the audio bandwidth. The special fondness for class A actually resulted from the desire to depart from the transistor sound of the sixties—a time when solid-state amplifier technology was exceedingly poor compared to modern standards. Enthusiasm for class A today is often supported by a variety of misunderstandings and myths. The following list provides some major examples.

1. “Crossover distortion in class B is a constant. At low listening levels, it becomes very prominent.” This is an understandable assumption, but fortunately it is not true. The absolute level of crossover distortion decreases as the output signal level is decreased, but not in a proportional manner. The principle behind this phenomenon will be discussed later. However, the end result is only a slight increase in THD as the output level is drastically reduced.

2. “Even though class A amplifiers are inefficient, they are easy to design, and the sonic quality will be exceptional even in poorly designed units.” In reality, a well-designed class A amplifier is about equal in complexity to a good class B design, and the class A amplifier will virtually always be more expensive. In addition, a mediocre to poor class A design can suffer from extreme large-signal nonlinearity

and transient distortion, causing the sonic quality to be significantly inferior to many class B designs.

3. “In comparison to class B designs, class A amplifiers sound better.” A well-designed class A amplifier operating under favorable conditions compared to a well-designed class B amplifier operating under the same conditions will not reveal any perceivable differences. Otherwise, the human ear would have to be capable of hearing distortion levels into the hundredths of a percent at 20 kHz. But we must be careful to compare apples with apples. There are many poorly designed class B amplifiers around, and their inferior performance characteristics are readily detectable.

There is no question that class A will continue to play a prominent role in esoteric audio. Class A designs have the potential of being almost distortionless if designed properly and used at reduced volume levels to accommodate musical transients. However, many of the popularized class A designs are not nearly as sonically pure as they are thought to be. Class A designs are notorious for circumventing any criticism because they are often constructed by subjectivists who don’t believe in testing their performance with a distortion analyzer.

CLASS AB

Class AB is not really a class but rather a poor marriage of both class A and class B characteristics. It has been erroneously taught that a class AB amplifier becomes a class B amplifier when all bias is removed from the OPS. This is incorrect. Technically speaking, class B pertains to an OPS wherein the output devices are conducting for one-half (that is, 180 degrees) of the signal cycle. In order to accomplish this action, a small forward bias must be applied to the output devices to overcome their inherent V_{be} drop. If this forward bias is removed from a class B OPS, the output devices begin to conduct for *less* than 180 degrees of the signal cycle, placing the OPS closer to the category of class C than class B.

Class AB pertains to a class B OPS that has been overbiased so that each output device conducts for more than 180 degrees of the signal cycle. This was thought to improve crossover distortion through the mental imagery of the output devices sliding through the crossover region in linear class A operation. However, what actually results is a form of crossover distortion referred to as *gm doubling*. That is, in the

crossover region while all of the output devices are conducting simultaneously, their current gain factors are doubling (i.e., summing), creating a severe wobble in the linearity. Both Fourier analysis and distortion analysis prove that this doubling effect causes distortion harmonics as bad as if the output devices were severely underbiased. Class AB operation also causes increased power dissipation in the OPS, decreasing efficiency and reliability. Since class AB operation provides no advantages whatsoever and only serves to degrade linearity and create additional heat problems, it should be entirely dismissed as a “good idea that just didn’t work out.”

CLASS B

As defined previously, class B pertains to an OPS wherein the output devices are biased to conduct for 180 degrees of the signal cycle. In times past, class B operation was referred to as *push-pull operation* (analogous to *sourcing-sinking action*), but this is a misnomer. Output devices in a class B OPS will source current to a load for a half-cycle, but they do not sink current during the opposite half-cycle: they are cut off. The term *push-pull* should be confined to class A type stages.

At least 99 percent of all audio power amplifiers utilize a class B OPS. I make no apology for the fact that this book is devoted to the methodology and development of class B audio amplifiers since that appears to be the only practical and viable choice at our current technological level.

CLASS C

An OPS biased so that the output devices conduct signal current for less than 50 percent of the signal cycle is classified as class C. Class C OPSs are used rather exclusively for RF applications. Their application within the audio fields appears to be nonexistent.

CLASS D

Class D amplification is totally different than any other class grouping in that it involves the complete destruction of the original analog signal, two conversion processes, and a final reconstruction of the original signal. A simplified explanation of the process goes something like this.

The original analog line-level signal is voltage amplified and converted to a high-frequency square wave, with the analog signal modu-

lated into the duty cycle of the square wave. In other words, the square wave train essentially carries the power wave of the original analog signal. Once the modulated square waves are properly integrated, the original analog signal will emerge. This technique of converting an analog signal into a power wave is called *pulse width modulation*, or PWM (not to be confused with *pulse code modulation*, which is an entirely different thing). The great advantage of PWM is OPS efficiency. Since the output devices are functioning as high-speed switches instead of operating in a linear region, efficiency can be close to 100 percent.

The first class D amplifiers came out in the form of a DIY kit in 1947. These kits didn't really pass the stage of a tinkerer's delight. Infinity Systems tried to market several improved designs in the 1970s, but they were plagued with many problems in the areas of reliability and poor sonics. After four years of marketing failures, class D was abandoned. During the mid-1980s, class D was again resurrected as being applicable for some commercial applications, and that is where it has remained to the present.

As stated earlier, the enticement of class D lies in its theoretical efficiency capability. While efficiencies of well over 90 percent have been obtained, the overall results have been less than exemplary in other areas of audio reproduction. In order to obtain any semblance of accurate linearity, the base frequency of the square wave generation must be at least 10 times higher than the highest audio frequency that the amplifier is designed to replicate. If the highest audio frequency is established at 20 kHz (a minimum that will not provide very good high-frequency transient response), the minimum frequency of the PWM square wave must be at least 200 kHz. Needless to say, the problems involved with minimizing RFI and EMI emissions from a 200-kHz square wave switched between the power supply rails is enormous. Also, the very nature of class D operation makes it very sensitive to output impedance variations.

In the context of high-quality audio systems, which is what this book is all about, class D does not have a place. To achieve the bandwidth and linearity that is normally associated with high-quality audio, the base frequency of the PWM square wave would have to be around 1 MHz. Output devices subjected to the task of trying to switch from one power supply rail to the other at a 1-MHz rate are going to waste more energy

in switching inefficiency than they would waste in normal class B operation. We seem to be limited by the laws of physics in this respect.

Several respectably large manufacturers have recently begun to market a variety of class D amplifiers intended for domestic hi-fi and professional public address applications. Since these units are not currently available for evaluation, I regret that I cannot comment on their performance.

QUICK >>> TIP

Before purchasing a class D amplifier, you may want to review the adjacent list of traditional performance weaknesses. It will be interesting to see if the newer generation of class D amplifiers has overcome these problems.

1. *Bandwidth:* It is easy to obtain bandwidths in excess of 50 kHz with almost any class B design. As explained in Chapter 3, a fairly broad ultrasonic bandwidth is desirable for ultrasonic transient processing. Class D amplifiers of the past have rated very poorly in this characteristic.
2. *Sensitivity to output impedance variations:* Traditionally, class D amplifiers have required a very stable output impedance, and this is something hard to find with almost any real-world speaker system.
3. *Distortion:* Distortion at 1 kHz is not the concern with class D amplifiers. If the base frequency of the PWM square wave is relatively low (i.e., 200 kHz or less), distortion measurements at 1 kHz could look fine, but a 20-kHz sine wave could turn out looking more like a square wave. Be especially critical of distortion analysis for the upper part of the audio bandwidth—in the 15- to 20-kHz range. If the manufacturer does not provide these specifications, don't buy the amplifier.
4. *Reliability:* The seventies vintage class D amplifiers were devastated by reliability problems. Hopefully, with two decades of technological advancements, the new generation of class D amplifiers will work out much better in this respect.

CLASS E

Class E is a radio frequency method of reducing power dissipation in a transistor. As in the case of class C, class E is not applicable to the audio fields.

CLASS G

Class G is a method of combining two class B stages into one, with one class B stage operating from low-voltage rails while the other operates from higher-voltage rails. The object of this class is to improve efficiency. In theory, the low-power (and low-dissipation) class B stage can handle the brunt of the load for the majority of applications, while the high-power class B stage is on constant standby, instantaneously processing the high-level audio outputs, peaks, and transients. The automatic switching from one stage to another is performed by “commutation diodes.”

Class G is a novel idea, but the modest improvement in efficiency is hard to justify in light of the requirement to supply quad power rails, a double set of output devices, and the additional complexity of the commutation network. Even the highest-quality class G designs have proven somewhat inferior in performance to class B amplifiers, so there seems to be little enticement to pursue class G amplifiers to any further state of development.

CLASS H

Class H is another attempt at improving the efficiency of a class B amplifier. It achieves the same basic results as class G, but instead of switching between two sets of power supply rails, class H architectures dynamically adjust the power supply levels to accommodate the power output requirements. In principle, this amounts to increasing the power supply voltage when higher output power is desired.

Class H designs overcome the added cost and complexity of dual output stages and commutation networks as compared to class G designs. But the technique of dynamically varying the power supply is a tricky one. This has usually been accomplished through a type of bootstrap control, but other methods have also been attempted with varying degrees of success. Again, as in the case of class G, the modest efficiency benefits hardly seem worth the effort.

CLASS S

Class S appears to have been named after Doctor A. Sandman, who developed the system. (It is also used to describe a type of vacuum

tube biasing that is unconnected to audio technology.) Class S audio systems incorporate a low-power class A amplifier to drive a load that has been backed up with a class B stage. In other words, the class B stage makes the load appear to have a higher impedance, which can be efficiently driven with a small class A amplifier.

AMBIGUOUS CLASSES

Throughout the relatively short history of high-quality audio development, there have been many designs utilizing two or more of the principles involved in the major amplifier classes. For example, Quad's famous current-dumping amplifier, introduced in 1975, is a sort of hybrid combination of class A and class B techniques. Carver's well-known modern line of amplifiers is designated as "class H" by the manufacturer, but some audiophiles refer to it as "adaptive class G." From a technical perspective, it is obvious that the Carver systems utilize some of the benefits of both classes.

In summary, the battle of the classes is relatively unimportant to the typical audiophile. Classes AB, C, and E can simply be dismissed as either bad ideas or not applicable. In my opinion, class D is going to have a difficult time in obtaining the performance levels of class B, if it is possible at all. Class D marketing personnel are also facing formidable problems with class D's past reputation. Classes G and H are only cost-effective if very high output power (that is, 800 watts RMS or higher) is demanded from a reasonably small housing, and their sonic quality is slightly lower than top-notch class B designs. It appears class S has fallen into the realms of antiquity.

Therefore, to the serious audiophile and amplifier builder, the decision of class type boils down to the decision between class A and class B. As stated earlier, class A designs are impractical, but so are diamond rings and two-seater sports cars. I have nothing against class A—I like to build them myself from time to time. In respect to the combined attributes of sonic quality, efficiency, practicality, reliability, and complexity, the Lin three-stage class B architecture is "heads above" any other design approach. Virtually all of the classic amplifiers of the past and present are class B designs, and 99 percent of all amplifiers currently being manufactured are class B.

Class A Designs

Basic Class A Architectures

Figure 6.1 illustrates the three fundamental types of Class A OPSs. In its simplest form, a class A stage can take on the design shown in Figure 6.1(a), in which a passive resistor serves as an emitter load for the OPS transistor. When the transistor is close to saturation, maximum current can flow from the positive rail to the speaker load.

When the transistor is close to cutoff, the current must flow from the negative rail through emitter load R_E before flowing through the speaker load to circuit common. The power dissipated in resistor R_E is roughly equivalent to the power delivered to the speaker load, bringing the already poor efficiency levels of class A to an intolerable level.

An analysis of the output efficiency under ideal conditions reveals that 50 percent of the available power must be dissipated in maintaining quiescent current (I_q), so that the emitter of the transistor can provide the maximum voltage swing. Of the remaining 50 percent of signal power, the transistor must dissipate 50 percent, and R_E must dissipate an additional 25 percent. In simple terms, a class A circuit of this type can yield an efficiency of only $12\frac{1}{2}$ percent under ideal conditions, which is totally impractical in all but low-power, signal-level circuits.

Figure 6.1(b) illustrates another single-ended class A design utilizing an active *constant current source* (CCS) in place of a passive resistor. CCS is set to the proper I_q value, so that when the transistor is close to cutoff, the entire I_q value is allowed to flow through the speaker load without wasting power in a passive resistor. This technique doubles the ideal efficiency of the previous circuit; bringing it up to a maximum of 25 percent.

Figure 6.1(c) shows the basic principle behind a push-pull class A OPS. A quiescent voltage bias, hereafter called “ V_{bias} ,” is applied to the bases of the complementary transistor pair. V_{bias} establishes a quiescent collector-emitter current flow through both transistors of sufficient level to allow each complementary transistor emitter to provide a peak-to-peak voltage swing close to

QUICK TIP

Technically speaking, current always flows from negative to positive. However, throughout the course of this book, it is easier to always consider current flowing from the power supply rails to the speaker load, regardless of polarity.

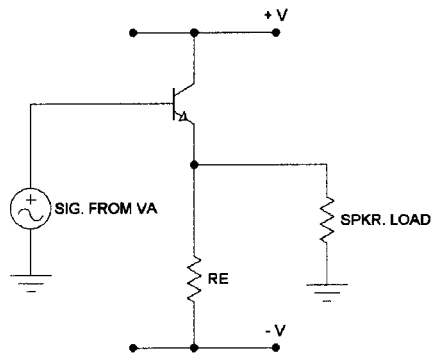

(a) Single-ended, resistive-loaded class A stage
Maximum efficiency = 12.5%

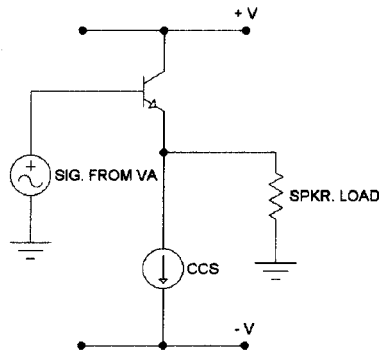

(b) Single-ended, actively-loaded class A stage
Maximum efficiency = 25%

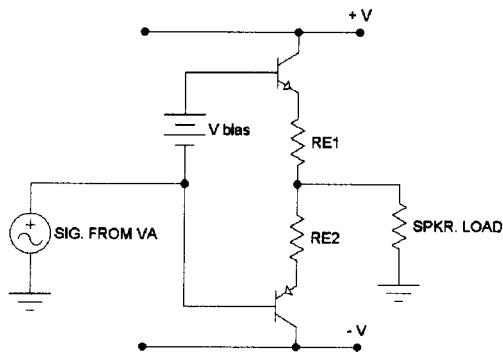

(c) Push-pull class A stage
Maximum efficiency = 50%

FIGURE 6.1

Class A output stage configurations and quiescent current regulator systems.

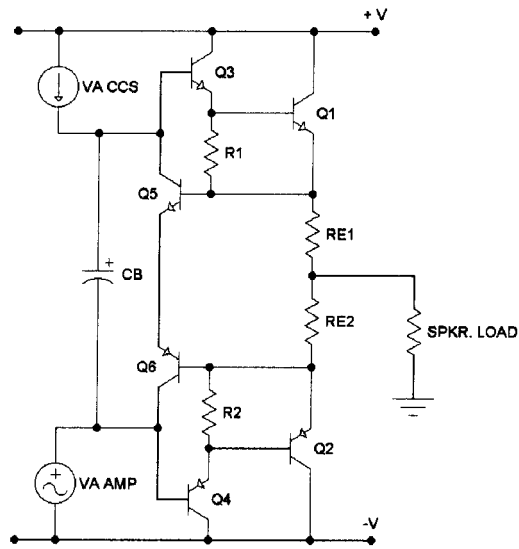

(D) A balanced class A quiescent current regulator

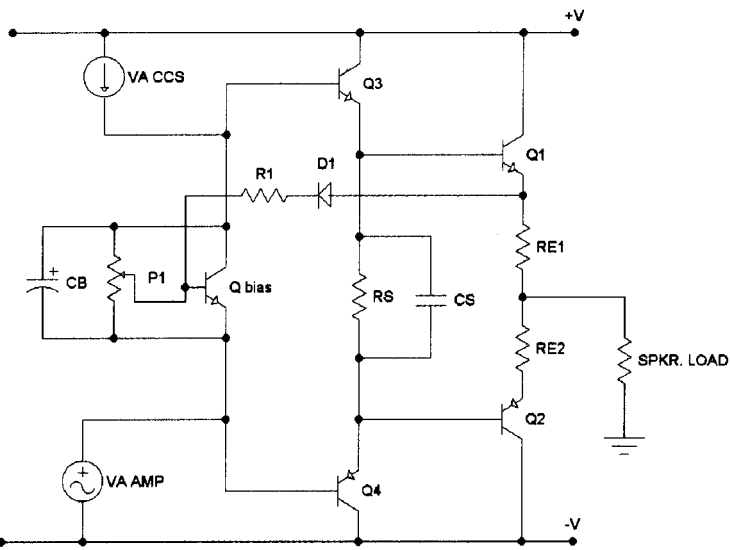

(e) Single-ended class A quiescent current regulator

FIGURE 6.1

Class A output stage configurations and quiescent current regulator systems.
(Continued)

the value of the sum of the rail voltages. In other words, if the power supply rails of Figure 6.1(c) happened to be at positive and negative 30-volt potentials, the maximum peak-to-peak voltage swing of either transistor emitter would be close to 60 volts. While in class A operation, both transistors stay in their linear conduction region at all times.

There are two major advantages to a push-pull class A design in contrast to the previous examples. First, the efficiency can approach 50 percent (assuming ideal conditions at maximum output level). Under dynamic conditions, one transistor is always turning off as the other transistor is turning on. As one transistor is turning on, resulting in an increasing current flow through its emitter, the other transistor is in the process of turning off, causing an increase in its emitter impedance and forcing more signal current to be shunted through the speaker load. As signal excursions go from one extreme to the other, the signal current through the load is effectively doubled in comparison to the single-ended active-loading technique of Figure 6.1(b), resulting in a doubling of output efficiency.

A second major advantage of this type of class A architecture is that it will automatically go into class AB action when overdriven out of the class A mode. Remember, the only difference between class A and class AB is the quiescent bias setting. If the combination of peak signal voltage excursions (from the VA stage) and speaker load impedance is such that the class A quiescent current setting is exceeded, the output transistors will alternately be driven into cutoff. In other words, intermittent class AB action results, assuming the power supply rail potentials are high enough to handle it. This is very good because it allows us to design class A amplifiers with some headroom for signal transients and/or improved performance when forced to drive excessively low impedance loads.

As stated earlier, class AB performance is inferior to class B performance, but it is infinitely superior to clipping! So it is highly desirable to design a class A amplifier with the capability of going from excellent performance to good performance during loading extremes or musical transients, without experiencing tweeter revolt or having to get out of your favorite recliner to twiddle with a volume control.

Class A Biasing Methods

The quiescent collector-emitter current flow through the output devices of a class A OPS is a crucial matter. In the simplest way of visu-

alizing it, the quiescent output current (hereafter called I_q), must be slightly higher than one-half of the current flow that would result if you tied the output load to either one of the power supply rails. For example, if you connected an 8-ohm resistive load to a 24-volt DC power supply rail, the current flow through the load would be 3 amps. Therefore, if you intend driving an 8-ohm load with a class A amplifier operating from 24-volt power supply rails, the I_q would have to be around 1.5 amps. In the ideal perspective, this provides a linear current swing of each complementary output device between 0 and 3 amps, allowing each device to source up to 3 amps during peak signal excursions. Obviously there are real-world losses and inefficiencies to consider, but the basic principle is accurate.

In a class B OPS, precise V_{bias} setting (critical down to hundredths of a volt) and accurate thermal tracking are mandatory for optimum distortion performance and control over thermal runaway. In contrast, I_q in class A OPSs is not nearly as critical, allowing considerable tolerance and temperature drift before any sonic degradation develops. It boils down to the simple task of making sure the output devices stay in the linear portion of their load line.

Figure 6.1(d) and 6.1(e) illustrates two common methods of maintaining the optimum I_q value in a class A OPS. In Figure 6.1(d), Q5 and Q6 sense the sum of the voltage drops across RE1 and RE2, which is proportional to I_q . If this summed sense voltage exceeds the combined V_{be} drops of Q5 and Q6, the V_{bias} applied to the bases of Q3 and Q4 is reduced, lowering I_q . If the opposite occurs, and the summed sense voltage drops below the V_{be} drops of Q5 and Q6, V_{bias} is increased forcing a subsequent increase in I_q . In effect, I_q is regulated based on the stable voltage reference of the V_{be} parameters of Q5 and Q6. This is the same principle used to construct the active constant current sources previously examined.

The summed voltage drop across RE1 and RE2 will always be proportional to I_q in the practical sense, even under dynamic operation. The individual voltage drops across RE1 and RE2 will contain a proportional content of signal voltage, but since the output transistors (Q1 and Q2) are dynamically operating in phase opposition, the algebraic sum of the signal voltages across RE1 and RE2 must always equal zero, provided that the resistance values of RE1 and RE2 are the same. Obviously, this is assuming ideal conditions. In the real world, the resistance values of

RE1 and RE2 will not be exactly the same, and there will be slight differences in the operational parameters of Q1 and Q2. These unbalanced conditions cause some small dynamic variations in the summed sense voltage across RE1 and RE2; therefore a smoothing capacitor, CB, is placed across the collectors of Q5 and Q6 to stabilize the Vbias level. A typical value of about 220 μF for CB provides excellent results.

There are two disadvantages to the Iq regulator illustrated in Figure 6.1(d). Since the absolute value of Iq depends on the summed voltage drops across RE1 and RE2, the total resistance value of RE1 and RE2 is the primary variable in establishing the Iq setting. Since RE1 and RE2 must be of the power resistor variety (typically 5-watt resistors), the exact resistance needed to establish the desired Iq might not be readily available. This problem is easily overcome by the incorporation of various series or parallel trimming resistors, but it is an inconvenience. The second disadvantage involves the Vbe variations of Q5 and Q6 with temperature change. As the junction temperatures of Q5 and Q6 increase, the absolute value of Iq can significantly decrease. Therefore, the solution to this problem is to keep Q5 and Q6 as well isolated from temperature variations as possible.

The circuit of Figure 6.1(d) has been promoted as having the secondary function of providing short-circuit protection for the output devices. If, for example, the speaker load is shorted to circuit common, the entire output signal tries to appear across RE1 and RE2. Before this can happen however, the increased base drive to Q5 and Q6 limits the maximum output current by shunting the drive signal away from the bases of Q3 and Q4. In other words, transistors Q5 and Q6 form a simple VI limiter. Unfortunately, for practical applications involving BJT outputs, this attribute is of little benefit. Simple VI limiting has the disadvantage of either severely restricting the power output capabilities of an amplifier or leaving the BJT output devices vulnerable to destruction by the effects of secondary breakdown. If the output devices are MOSFETs (which are not susceptible to secondary breakdown), this circuit can provide very good protection. More will be discussed about amplifier protection methods in Chapter 8.

Figure 6.1(e) represents an Iq regulator with a little more flexibility. The voltage at the top of RE1 is applied to the base of “Q bias” through D1 and R1. The emitter of Q bias is electrically related to the bottom of RE2 through the base-emitter junctions of Q4 and Q2. Consequently,

the entire voltage sense loop consists of the voltage drops across RE1, RE2, and the V_{be} of Q4 and Q2. These four voltage drops are compared to the V_{be} drop of Q bias, resulting in the establishment of V_{bias} across the collector and emitter leads of Q bias. In principle, the V_{be} drop of Q bias is the voltage reference to which the sensed voltage drops are compared. As the sensed voltages try to increase (mainly proportional to an increase in current flow), V_{bias} decreases due to the increased base drive to Q bias, and vice versa. The result is a regulated I_q . CB filters small signal variations applied to the bias network.

At first glance, the circuit of Figure 6.1(e) seems a little crude, especially upon considering the V_{be} variations of Q4 and Q2 with temperature changes. Initially, this circuit was the I_q regulator for the class A amplifier design of Figure 6.2(a) (see next section). With P1 adjusted for an I_q value of 1.5 amps per output leg, and all transistors mounted to the same heatsink, I_q would decrease by about 3 mA/°C rise in output device temperature. (Component values were D1 = 1N4148, R1 = 2.2 k Ω , P1 = 5 k Ω , Qbias = 2N5551, and RE1 = RE2 = 0.68 Ω .) With a compromise setting of P1, this circuit worked very well with the amplifier of Figure 6.2(a).

Figure 6.1(d) and 6.1 (e) represent only two of many possible methods of regulating I_q . Virtually all systems that I am aware of utilize the voltage drops across the RE resistors to monitor I_q . This sensed voltage is then compared to a stable voltage reference for V_{bias} correction. An op-amp and precision voltage reference could easily be combined to regulate I_q down to infinitesimal proportions. From a practical perspective, however, I don't see a need for significant improvement over the performance of the circuits (and their variations) illustrated in Figure 6.1(d) and (e).

A High-Performance Class A Cookbook Design

If you would like to build a high-performance class A audio amplifier, I submit the design of Figure 6.2(a) for your consideration. This is a no-compromise, high-end design providing nothing short of spectacular performance.

I initially hesitated at including such a complex design at this point. However, I reasoned that it would be quite pointless to include various inferior class A designs in the process of working up to the best status because anyone willing to pay all the additional

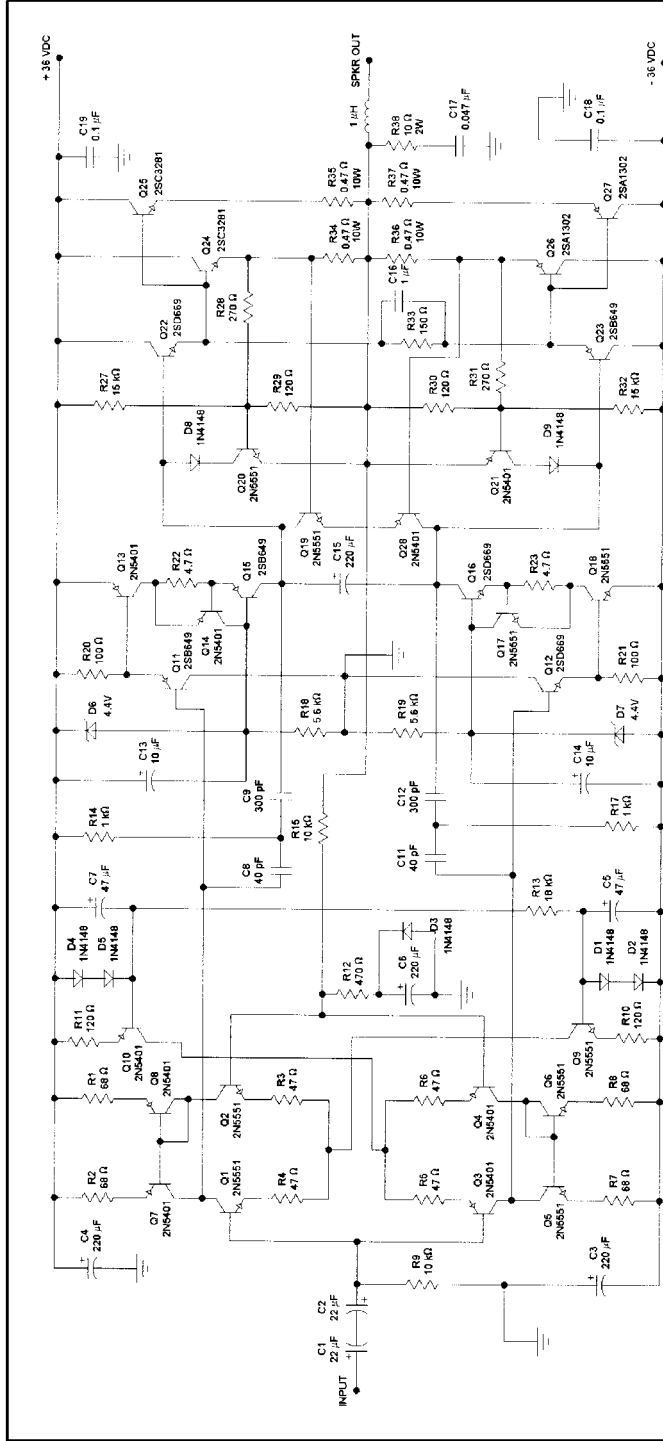

THD with 8 ohm load = 0.0018%
 THD with 4 ohm load = 0.005%

Output DC offset = 1uV

I_q of each output leg = 1.5 amps

Class A output (max) = 40 watts RMS

Max. Output at clip = 60.5 watts RMS

2nd order harmonic distortion @ 1 kHz = 0.00001%

@ 20 kHz = 0.00017%

3rd order harmonic distortion @ 1 kHz = 0.000018%

@ 20 kHz = 0.00013%

FIGURE 6.2a

High-performance Class A 40-watt RMS amplifier.

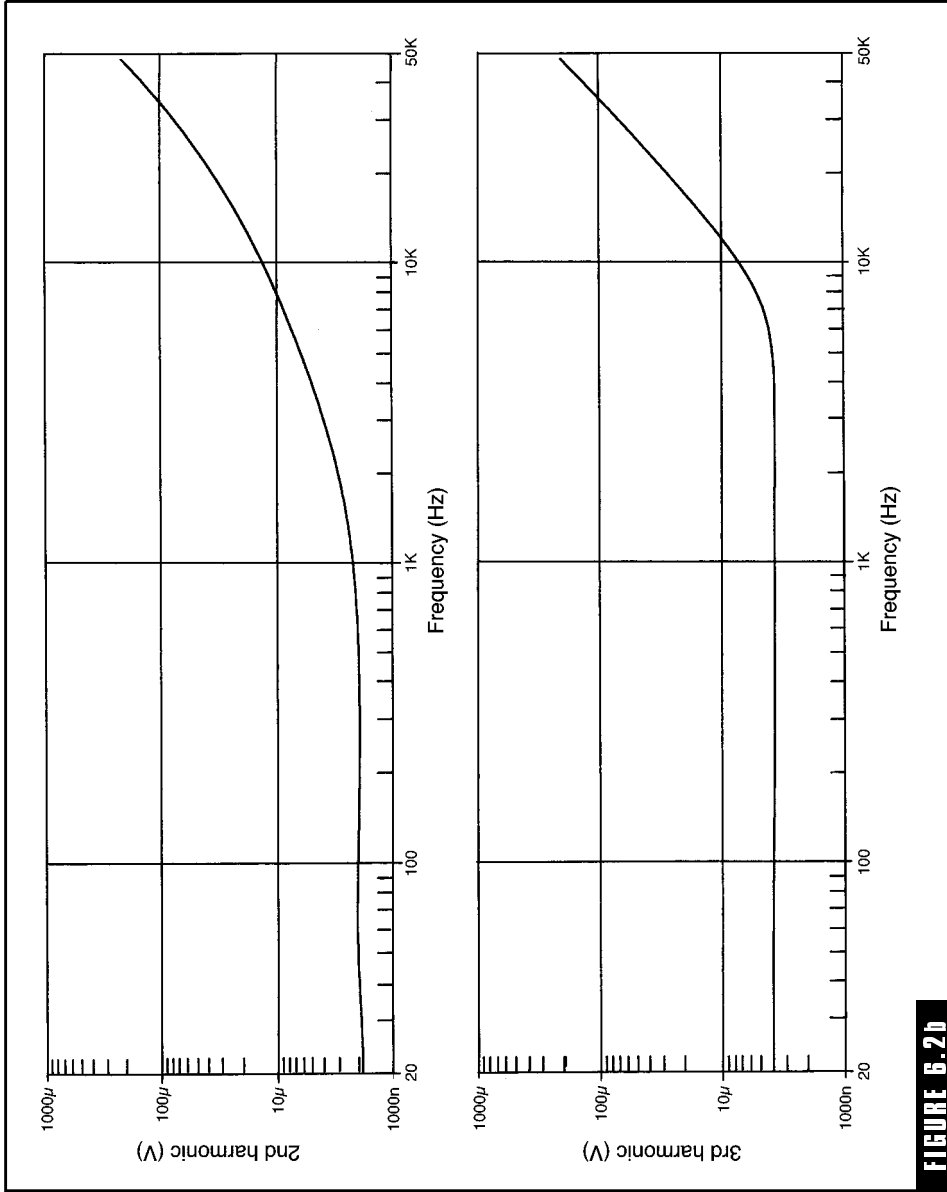

FIGURE 6.2D

Distortion graph: Illustrates the excellent linearity of the amplifier design in Figure 6.2 (c).

expenses involved with class A construction is not going to be satisfied with less than the best. I certainly do not recommend this design for a first-project attempt; it is provided for those who are already experienced in amplifier construction. However, there is no reason that the experienced amateur cannot have excellent success with this design, provided he (or she) progresses up to it with some of the easier projects provided later on in this book. The following is a brief discussion of the amplifier's construction and performance details.

The front-end design of the amplifier is identical to the input stage and VA combination provided in Figure 5.8(a) of the previous chapter, with the following exceptions. The RC feedforward network (R16 and C10 of Figure 5.8(a)) has been omitted due to the lack of high-voltage swings and crossover artifacts at the speaker output. In short, it doesn't provide any significant performance improvements. R18, R19, and R13 have been reduced in resistance value to compensate for the lower rail voltages.

The quiescent OPS current, I_q , is regulated by a variation of the circuit illustrated in Figure 6.1(d). Q19 and Q28 form the regulation circuit and maintain I_q by monitoring the summed voltage drops of R34 and R36. With the values shown, I_q comes out to about 1.5 amps per output leg (i.e., per output transistor emitter).

The basic design of the OPS is a paralleled emitter-follower type, as illustrated in Figure 6.5(a) (detailed later in this chapter). The output devices specified are *flat-pack devices* (similar to a TO247 package) and should not be allowed to exceed 75°C for optimum reliability. Other similarly rated output devices, such as the MJ15003 and MJ15004 complementary pairs, will function equally well in this design.

D8, Q20, Q21, D9, R27, R29, R30, R32, R28, and R31 make up a single-slope overload protection circuit (often called a *SOAR circuit*). This circuit monitors the output current relative to the power supply rails to ensure that the output transistors do not exceed their recommended *safe operating region*, or "SOAR." Failure to provide this type of protection could result in the output devices suffering from destructive secondary breakdown under certain conditions.

For optimum performance, the amplifier will require a dual-polarity raw DC power supply utilizing a power transformer with a 50 VCT,

8-amp secondary rating and at least 10,000 μF of capacitor filtering per rail supply. A power transformer with a secondary current rating of 6 amps will function properly, but it becomes very warm when the amplifier is powering 4-ohm speaker loads. This amplifier has an idling dissipation of about 200 watts, so a heatsink with a $0.2^\circ\text{C}/\text{W}$ rating is needed for mounting to the output devices. With proper ventilation techniques, the heatsink temperature should not exceed 67°C , but I also recommend that a 75°C thermostat be installed on the heatsink for automatic thermal shutdown protection.

Note: Before jumping into this project, you may want to check out how expensive the aforementioned items are.

There are few critical concerns regarding the layout. All six of the output devices should be mounted to the same heatsink assembly. The Iq regulator transistors, Q19 and Q28, should be isolated from heat sources to the extent possible in practical layout. The remainder of layout design should simply be governed by the standard rules of good layout practice.

As stated previously, the push-pull design of this amplifier allows it to automatically slip into class AB mode if the class A maximums are exceeded. It will deliver 40 watts RMS into an 8-ohm load while in class A mode, and 60 watts RMS in class AB. This characteristic provides some significant headroom for musical transients if the amplifier is used at close to maximum power levels. When powering 4-ohm loads, the amplifier will deliver about 100 watts RMS in class AB mode, with very good distortion performance (see THD specifications in Figure 6.2). Clipping occurs at 60.5 watts (8-ohm load), and overload clipping begins when the speaker load drops below 2.4 ohms.

Besides the exceptional performance, there are a few other little features I like about this design. First, it doesn't require any exotic components; the components specified are inexpensive and readily accessible. Second, the design is repeatable, very stable, reliable (due to the four separate self-protection circuits incorporated), and forgiving of input-output and power supply upsets (a result of the four-quadrant transient immunity inherent to a mirror-image topology). And finally, I really like the fact that there are no trimpots or set-up adjustments to make. You just apply power and it runs!

BJT Class B Output Stages

The OPS of an audio power amplifier performs a simple task; it amplifies current in a near-unity voltage gain environment. The simplest way (in theory) to accomplish this is with a class A OPS, which we have just examined. Unfortunately, class A output designs are prohibitively inefficient, so a more practical method is required to imitate class A action. Class B operation is a method of arranging pairs of complementary devices in an opposing mode of operation, so that one device amplifies all positive polarity signal voltages while its complement amplifies all negative polarity voltages, with polarity being referenced from a common locus to the complementary pair.

The definition of class B operation has often been simplistically defined as “one transistor amplifying the positive half-cycle of a signal voltage while the other transistor amplifies the negative half-cycle.” This definition is inadequate in several ways. First, complex musical signals often contain high-frequency harmonics “riding” on low-frequency waveforms, requiring a single class B output device to amplify multiple complete signal cycles. For example, in a situation where a 10-kHz low-amplitude waveform is riding on a 1-kHz high-amplitude wave, a class B output device may be required to amplify three complete cycles of the 10-kHz signal while it is being pushed into the positive region by the 1-kHz wave. Second, in the absence of qualifying statements, the terms *positive* and *negative* are always assumed to be in reference to circuit common. With amplifiers utilizing capacitor coupled or transformer coupled OPSs, the signal voltage may never go into the negative or positive region (depending on design orientation) in reference to circuit common.

Class B stages are often erroneously referred to as “push-pull stages.” *Push-pull* refers to complementary device action wherein one device acts as a current source while the other is a current sink, and vice versa. In other words, one transistor pushes current while the other transistor pulls current, with the conditions reversing at a bi-cyclic rate. The term *push-pull* originated with vacuum tube amplifiers, with the associated visualization of the output tubes “pushing” and “pulling” current through the primary of an output transformer. Push-pull, although somewhat antiquated, is perfectly applicable to complementary output class A solid-state amplifiers. However, it is not

applicable to class B. In class B operation, each complementary device alternately sources (i.e., pushes) current, but when it is not sourcing current, it is cut off. Therefore, to use similar terminology, we would have to describe a class B OPS as a “push-cutoff” stage. Since the theoretical concept of a transistor pushing current is not a good one to begin with, I consider it preferable to simply use the term *class B*.

Virtually all modern class B audio amplifiers have an OPS that is equivalent to, or a variation of, one of the four circuits illustrated in Figure 6.3. All of these designs have their strong points and weaknesses, which we will discuss in detail in the following sections.

The Emitter-Follower Output Stage

Figure 6.3(a) illustrates a typical emitter-follower (EF) class B OPS with functional component values inserted. As is readily apparent, an EF OPS is simply a complementary Darlington topology. Optimum performance for this type of OPS is achieved with a DC bias of approximately 2.8 volts. This is reasonable since the four transistor base-emitter junctions form a series loop around the bias voltage. If the V_{be} of each transistor is assumed to be the rule-of-thumb value of 0.67 volts, the summation of all four junctions comes out to 2.68 volts, which is very close to the optimum bias potential.

The ideal setting for V_{bias} is the setting that would cause each output transistor (that is, Q3 and Q4) to conduct for *exactly* 180 degrees of an applied sine wave signal. In other words, Q3 should turn off at the precise time that Q4 turns on, and vice versa. (I know several married couples who act the same way.) Unfortunately, the ideal setting for V_{bias} does not exist; the most we can achieve is a best-fit setting. This best-fit setting comes as close as possible to a 180 degree conduction angle for each complementary output device. Any increase in V_{bias} from this optimum setting will increase crossover distortion through gm doubling, as previously explained. Decreasing V_{bias} from its optimum point increases crossover distortion through the beginnings of class C operation.

EF OPSs have a unique advantage over other design types regarding crossover distortion at low output levels. This is a trait that is generally not well known, but it is certainly worth considering. The crossover voltage range of an EF OPS is very wide in comparison to CF stages, extending to dual-polarity extremes of about 6 volts from the quiescent output

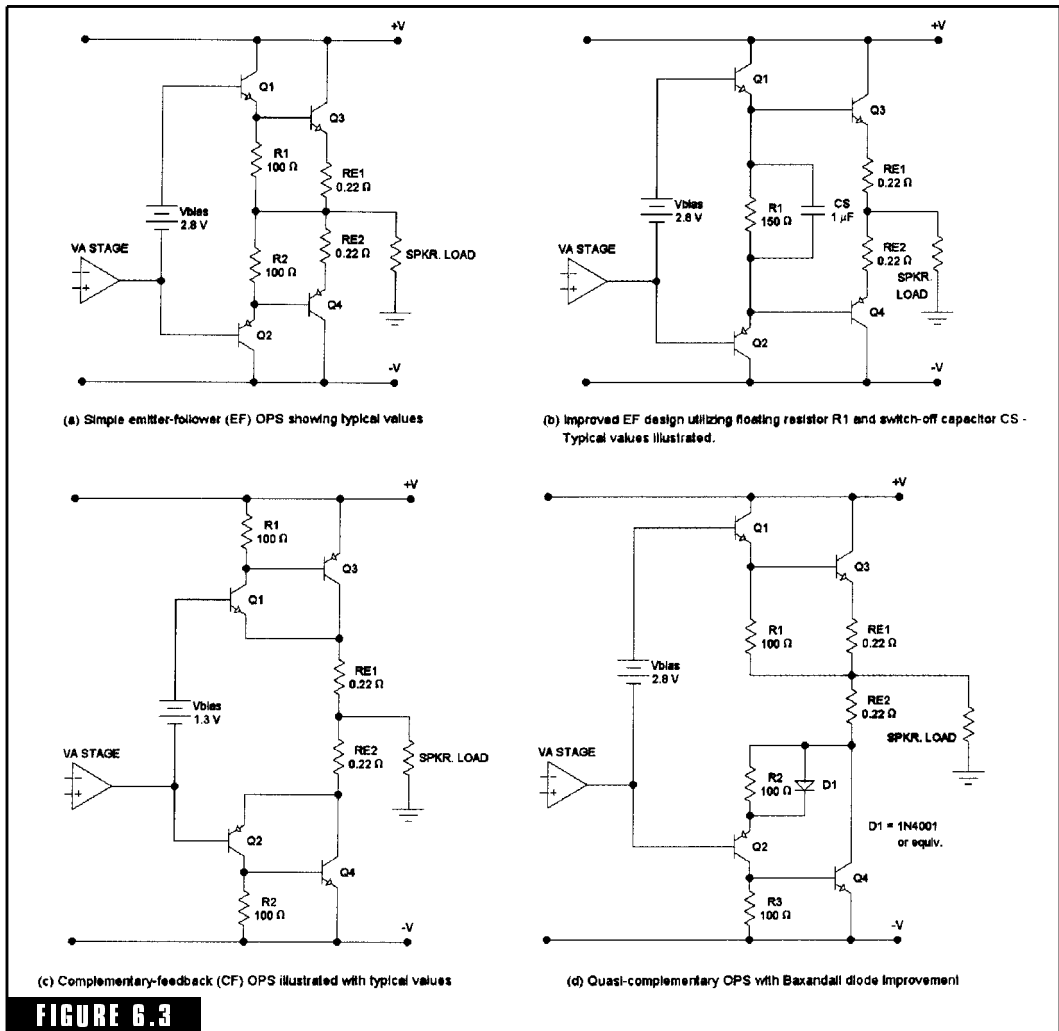

The four major class B output topologies for use with BJT output devices.

rail potential. At lower output voltages, the slope of the output voltage in the crossover region greatly increases toward the horizontal plane, causing the usual high-frequency harmonic artifacts of crossover distortion to radically decrease in frequency. While this does not decrease the level of crossover distortion, it places it in a lower-frequency realm where the global NFB of the amplifier can effectively reduce it. The end result is that a well-designed amplifier with an EF OPS can be almost totally free of crossover distortion at low power levels (i.e., about 2 watts or less).

This is more significant than it sounds at first. We must remember that if crossover distortion could be detected at all, it would have to be at very low output levels. Only the integral physics of an EF OPS can virtually eliminate it at this point. Crossover distortion reduces with output level in CF OPSs also, but the narrower width of the crossover region modifies the physics involved. Unfortunately, crossover artifacts in a CF OPS during low-level output will be about six times higher than in comparable EF designs.

Referring to Figure 6.3(a), transistors Q1 and Q2 are typically referred to as the OPS predrivers. In function, they serve as a complementary buffer stage to reduce loading effects on the VA. Another way of saying the same thing is to describe their function as “beta enhancers” for the output transistors.

A functional analysis of Figure 6.3(a) reveals some difficult obstacles in our quest for sonic purity. The output of the VA, which is linear class A with a falling impedance as the signal frequency is increasing, is being applied to the input of the OPS, which is nonlinear (i.e., two dissimilar base-emitter junctions per every half-cycle of voltage swing) and reflective of the varying load conditions at the output. Needless to say, this isn't the best place to start for excellent linearity. To make matters worse, most predriver transistors must dissipate a significant amount of heat (1 to 10 watts, on the average), but they are usually mounted to small individual heatsinks that are not thermally related to the heatsink for the output devices. Therefore, in each complementary half, we are now plagued with two dissimilar base-emitter junctions that will heat up but will not thermally track. V_{bias} can be set to thermally compensate for one junction temperature, but not both.

Thermal tracking is the automatic adjustment of V_{bias} relative to OPS semiconductor temperatures. In a BJT OPS, V_{bias} must decrease as semiconductor temperature increases to compensate for the increased leakage currents resulting from the positive temperature coefficient inherent to all BJT semiconductors. Otherwise, the output devices will eventually go into a self-destructive mode known as *thermal runaway*. By itself, this is relatively easy to accomplish. However, in addition to protecting the output devices from thermal runaway, V_{bias} must be accurately reduced with temperature increase while remaining at the optimum setting. If V_{bias} doesn't track accurately

with temperature changes, the obvious result will be increased distortion. This is not a minor consideration because distortion will increase significantly with only small changes in the optimum V_{bias} point.

Accurate thermal tracking is one of the major shortcomings of the EF topology. The V_{bias} transistor must try to thermally track the temperature of the output devices through the heatsink. The predriver transistors are indirectly accounted for in this thermal control loop through their quiescent effect on the output transistors, but thermal compensation based on their actual temperature is totally lacking. Therefore, accurate thermal tracking in an EF design is partially reliant upon proper techniques of mechanical placement regarding the predriver transistors.

Another disadvantage of EF topologies is the quiescent power dissipation in an idle condition. *Idling* refers to the state of an audio power amplifier with operational power applied, but with no input signal or output signal being processed. The compound conditions of a higher V_{bias} (needed to forward bias four base-emitter junctions) added to the lack of any voltage gain in the predriver stage cause the idling efficiency of an EF OPS to be rather poor compared to CF OPSs. Depending on the rail voltages, it is typical for a single-pair EF OPS to dissipate about 10 to 15 watts while idling. Comparable CF OPSs will only dissipate 1 or 2 watts.

At this point, I'll just say that there are methods of overcoming all of the previously mentioned problems. One of the high-performance EF designs detailed in Chapter 11, which I nicknamed the "Protran 1," provides a THD performance of 0.0029 percent at 150 watts RMS. This is only 1.1 "thousandths" of a percent higher than the class A design of Figure 6.2(a). The methods of improving all OPS topologies will be discussed in more detail later. For the moment, we will simply concentrate on the differing OPS topologies and their analysis.

Figure 6.3(b) illustrates an improved EF design. All operation and analysis are identical to the circuit of Figure 6.3(a) with the exception of the modified switchoff action provided by R1 and CS. To fully appreciate the function of this improvement, we must first understand the problem.

High-power output transistors must be capable of controlling high currents and dissipating relatively high power losses. The only way these characteristics can be incorporated into a transistor is by increasing

the size of the internal semiconductor chip. Unfortunately, this also results in a proportional increase of junction capacitance, which explains the typical sluggishness associated with high-power transistors. In the class A mode of OPS operation, the internal capacitance of the output transistors is only a concern in regard to stability. But in class B OPS operation, the output transistors must be turned off rapidly when their conduction period ceases, or we wind up with the very undesirable condition of both output transistors conducting simultaneously. This condition of simultaneous conduction is commonly referred to as *cross-conduction*. At best, cross-conduction will increase distortion, with the worst-case scenario resulting in rapid overheating and the destruction of the output devices. Increased distortion resulting from cross-conduction is appropriately called *switching distortion*, and it is one of the three primary problematic areas of OPS performance.

Referring to Figure 6.3(b), assume a positive voltage swing has just occurred, leaving a positive charge at the base of Q3. As the signal voltage from the VA swings into the negative region, the voltage at the emitter of Q2 must already be 0.67 volt more negative than the emitter of Q4 in order to overcome Q4's V_{be} drop. As current begins to flow through RE2, it also begins to drop a negative voltage, which is summed (or corrected, however you want to look at it) at Q2's emitter, increasing the negative potential. This small negative potential is applied to the base of Q3 through R1 and speed-up capacitor CS. The negative potential forces the positive charge carriers to be rapidly sucked out of Q3's base and results in a rapid turn off. The reciprocal effect is applied to Q4's base during negative- to positive-going signal excursions.

Depending on the circuit design and the output devices used, the switchoff modification of Figure 6.3(b) can provide a dramatic improvement. Distortion residuals resulting from switching distortion are very similar to distortion residuals from crossover distortion. This has led many design engineers and audiophiles down a merry chase to reduce stubbornly high levels of crossover distortion when their real problem was switching distortion. Typically, switching distortion is not detectable at fundamental frequencies below 10 kHz.

In some OPS topologies, such as the complementary feedback and its variations, it is not possible to incorporate a switchoff network. In these cases, it helps to remember the other primary method of reducing

unwanted capacitance problems—reduce the impedance. For example, referring to Figure 6.3(a), switching distortion could be reduced in this circuit design by lowering the value of R1 and R2. This modification provides a lower-impedance discharge path for any stored charges at the bases of Q3 and Q4, but it also increases the power dissipation of the predrivers and accentuates the effects of beta droop.

By now, the astute reader may be wondering why I included a switchoff network in the amplifier design of Figure 6.2(a) (that is, R33 and C16) if switching distortion is not applicable to a class A design. The obvious reason why switching distortion is not a problem in a class A design is that output devices operating in class A mode do not switch off. However, the amplifier design of Figure 6.2(a) will automatically go into class AB operation when overdriven or used to power 4-ohm loads. Therefore, R33 and C16 were included to improve performance while operating in class AB mode.

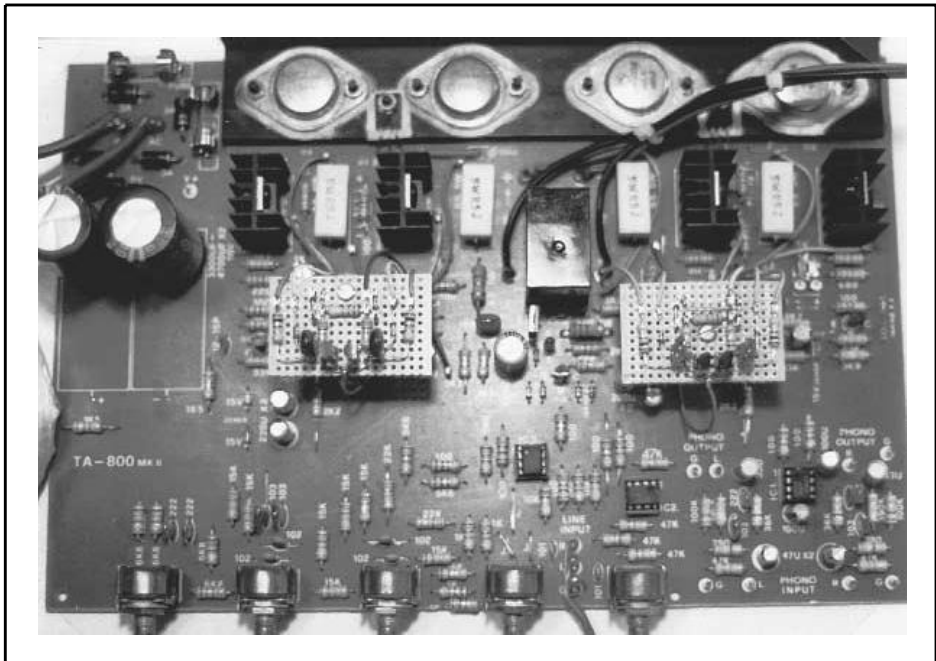

A commercial amplifier-preamplifier combination. Note the four predriver transistors mounted to the four square heatsinks in the upper portion of the photograph. Since this is an EF topology, the four predriver transistors are totally outside of the thermal tracking loop.

The Complementary-Feedback Output Stage

Figure 6.3(c) illustrates a typical design for a class B complementary-feedback (CF) OPS. Note that the optimum V_{bias} value is roughly only $1/2$ of the value required for EF designs. This is because there are only two V_{be} drops in the V_{bias} loop (that is, V_{be} of Q1 and Q2) in contrast to the four V_{be} drops of EF topologies.

The CF output configuration (sometimes called a *Sziklai pair*) provides three main operational differences in comparison to EF designs, which are all related to the fact that the predriver and output transistor are enclosed in a local NFB loop. First, it is only necessary to thermally track V_{bias} relative to the predriver transistors. Any thermal changes occurring in the output transistors will automatically be compensated for by the local NFB loop. Thus, the V_{bias} stability and accuracy are greatly improved over the EF topology. In addition, the idling efficiency is also improved over EF designs, as mentioned earlier. Second, CF stages are capable of both current and voltage gain. Of the rare amplifier designs incorporating voltage gain in the OPS, the CF architecture is used almost unanimously. Third, the local NFB loop provides an approximate 2:1 ratio improvement of OPS linearity before the global NFB loop is closed. Consequently, CF stages are inherently more linear from the onset (this is especially important at reducing the effects of beta droop).

It is important to analyze how the local NFB loop of a CF pair functions. Referring to Figure 6.3(c), note that the VA signal is applied to the predriver transistors (Q1 and Q2) in the same manner as in the EF design. However, the polarity orientation of the output transistors is reversed, with a pnp output transistor being used in conjunction with a npn predriver, and vice versa. The signal voltage is taken from the collectors of the predrivers, instead of the emitters, and the output transistors are turned upside down so that the speaker load is powered from the output transistor collectors instead of their emitters.

The signal voltage applied to the base of Q1 is inverted at the Q1 collector where it is applied to the base of Q3. Q3 is arranged as a common emitter amplifier with RE1 and the speaker acting as its collector load. The signal voltage is once again inverted at Q3's collector, so the output signal voltage across the speaker load is in phase with the original signal voltage from the VA. Q3's collector is also connected to Q1's emitter, providing 100 percent negative voltage feedback and establishing

the OPS voltage gain at unity (technically speaking, utilizing 0.22-ohm RE resistors, the OPS voltage gain is approximately 0.97). The identical complementary action occurs in the Q2/Q4 CF pair.

At first impression, it would seem that the CF configuration is far superior to the EF designs due to its better inherent linearity, improved thermal tracking characteristic, and increased flexibility regarding voltage gain. (Voltage gain manipulation is not really an advantage since it is rather pointless to incorporate in the first place.) Unfortunately, CF designs have two major drawbacks, and these factors must be included in an overall evaluation.

First, CF designs do not allow for any easy method of reducing switching distortion. Switchoff networks can be installed, but they require an additional set of higher-voltage power supply rails to work from. The added cost and complexity of additional supply rails seems a high price to pay for a characteristic that is virtually inherent to EF designs. Switchoff characteristics can be improved by reducing the resistance of the predriver collector loads [that is, R1 and R2 in Figure 6.3(c)], but there are additional problems created from this modification, as detailed earlier. Switchoff performance can also be improved by utilizing low-capacitance transistors for output devices.

A secondary problem involves stability. Referring back to Figure 6.3(a), visualize a small capacitor connected between the base and collector leads of transistors Q1 and Q3. This is representative of Miller capacitance, which is dependent upon voltage potentials, gain factors, and inherent junction capacitance. As the applied frequency to Q1 and Q3 is increased (considering only the positive halves of the signal voltage for discussion purposes), the Miller capacitance will eventually start to affect the circuit behavior, causing loss of gain, decrease in input impedance, output voltage rolloff, and voltage-lagging phase shift between the applied signal and the output signal. The lagging phase shift of Q1 and Q3 is additive, so that the Q1 phase shift will simply add to the phase shift of Q3, and the total phase shift at the speaker load will be the sum of the two. Instability resulting from phase shift problems is very unlikely within this OPS design because NFB from the output is not being applied back to the input.

In contrast, a CF stage has a 100 percent NFB loop inherent to its design. Referring to Figure 6.3(c), imagine two small capacitors between the base and collector leads of Q1 and Q3. As the applied sig-

nal frequency is increased (again, only considering the positive signal excursions), lagging phase shifts will begin to occur just as in the case of the EF stage. At some specific frequency, the junction capacitances of the CF pair can interact in such a way that a small amount of positive feedback will be applied to Q1's emitter, resulting in a voltage gain peak accompanied with ringing and some parasitic oscillatory effects.

Here is another way of looking at the same condition. Refer to Figure 6.3(c) and once again imagine two small capacitors (Miller capacitance) between the base and collector leads of transistors Q1 and Q3. Note that the imaginary capacitors are in series, with one end of R1 connected to their intersection point and the other end of R1 connected to the positive rail. What we have here, in reality, is a “two-pole compensation network!” However, to call it a “compensation network” is a misnomer since it is not needed for compensation but rather manifests itself as an undesirable stability glitch.

As you may recall in the previous discussion of two-pole compensation in Chapter 5, I explained why there would always be a peak in open-loop gain just prior to the knee of the gain rolloff. The same principle applies here. At the signal frequency wherein the capacitive reactance of Q3's Miller capacitance is roughly equal to the resistive value of R1, a significant percentage of positive feedback will result. An understanding of this condition provides us with several clues as to how to minimize it. More will be discussed on this topic later.

The severity of CF instability is highly dependent upon the transistor types incorporated. For example, utilizing the popular 2SA1302/2SC3281 pairs with the component values illustrated in Figure 6.3(c), the frequency of the voltage gain peak was about 2.1 MHz. With the same circuit using MJ15003/MJ15004 pairs, the gain peak occurred at about 17 MHz and was much less prominent. By comparing the data sheets for these devices, I suspect this to be more of a factor of device gain rather than listed static junction capacitance parameters (although both need to be considered).

The power supply rail potentials also have an effect on this phenomenon. For example, using the test circuit of Figure 6.3(c) with 2SA1302/2SC3281 device pairs, a rail voltage increase from 50 to 100 volts caused a voltage gain peak from 1.35 at 50 volts to 1.55 at 100 volts, with both peaks occurring at about 2 MHz. (Remember, a voltage gain higher than 1 is not possible in this CF design without

some positive feedback.) Since Miller capacitance is voltage dependent, it is not surprising that we would see such an effect.

As might be expected, adding a voltage gain factor to the CF OPS of Figure 6.3(c) improves stability because the percentage of feedback (both negative and positive) must be reduced. Unfortunately, depending on the transistor types incorporated, this can be a self-defeating technique. It could work out that by the time the voltage gain is increased to the point where a smooth high-frequency rolloff is obtained, the open-loop distortion of the CP pair might be prohibitive. As a final point of interest, I replaced all of the semiconductors of Figure 6.3(c) with 2N5551/2N5401 complementary pairs and increased the circuit resistance values to keep from exceeding the transistors' maximum current parameters. In running the same analysis tests as previously described, the two-pole instability glitch was, for all practical purposes, virtually nonexistent. This result came as no surprise, considering the low-capacitance parameters of most low-power transistor types. However, it serves to illustrate the importance of choosing the right output devices for optimum CF performance.

The Quasi-Complementary Output Stage

In the early days of high-performance audio power amplifier development, the quasi-complementary OPS was the only practical choice; the lack of quality high-power *pnp* devices pretty much eliminated all other options. When semiconductor manufacturers began to produce the high-quality complementary devices available on today's market, the quasi-complementary topology entered the realms of audio obscurity. To the best of my knowledge, the only power amplifiers currently marketed with quasi-complementary outputs are medium-quality public address amplifiers.

I am not convinced that the *quasi-complementary* (QC) topology should have been so completely abandoned, especially in light of the improvement introduced by Peter Baxandall, appropriately called the *Baxandall diode*. For the cost of an inexpensive 1N4001 diode, a QC stage can provide almost identical performance to an EF stage. This could be welcome news to anyone possessing a large inventory of high-power *nnp* transistors that they intend on making into Christmas tree ornaments. Also, from a manufacturing viewpoint, *nnp* power transistors tend to be less expensive than their *pnp* counterparts.

As Figure 6.3(d) illustrates, a QC stage is a marriage of EF and CF designs; Q1 and Q3 form an EF stage, while Q2 and Q4 make up a CF stage. The predriver transistors (Q1 and Q2) are a complementary pair, as in all of the previous OPS designs, but the high-power output transistors are both *npn* devices.

The early QC designs were plagued with two major problems affecting linearity. First, and most prominent, was the fact that the signal from the VA stage was loaded by two base-emitter junctions during positive excursions (i.e., the junctions of Q1 and Q3), but was only loaded by one base-emitter junction (Q2) during negative excursions. Not only did this create a nonsymmetrical load from the VA's perspective, it also produced a slight nonsymmetrical (i.e., noncomplementary) gain factor close to the crossover point. The incorporation of the Baxandall diode (D1) greatly reduced these problems, maintaining gain and symmetrically loading in a very close approximation to another base-emitter junction. The second major problem involves the dissimilar characteristics of emitter loading versus collector loading of the output transistors, especially at the crossover region. The nonlinear region of emitter voltage close to cutoff is very different from the nonlinear region of collector voltage approaching the cutoff point. Consequently, it becomes more difficult to mate the output devices for the lowest crossover artifacts. With sufficient global NFB and a well-designed input stage, this condition is not as bad as it was once thought to be. The result is that properly designed QC OPSs with adequate global NFB will provide distortion performance very close to that which is typical of EF designs.

QC stages are more prone to instability problems than EF designs, but not as much as CF stages. Referring to Figure 6.3(d), QC instability originates in the CF stage consisting of the bottom transistor pair Q2 and Q4. Based on the previous discussion of CF OPSs, this effect should come as no surprise. The reasons for this anomaly are the same as for any other CF stage, but the effect seems to be buffered to some degree by the complementary EF stage of Q1 and Q3. With V_{bias} set to its optimum point, the effect becomes almost nonexistent. However, with the almost infinite variety of QC output designs and loading combinations possible, it's impossible to make any guarantees that all QC designs will be perfectly stable.

Output Triples

Figure 6.4 illustrates two methods of constructing an OPS with six transistors, commonly called *triples*. Don't confuse OPS triples with OPSs incorporating paralleled output devices. Note that none of the output devices are paralleled in the examples of Figure 6.4. Also, OPSs incorporating Darlington pairs for predriver stages are not usually thought of as "triples." Traditionally (but not always), Darlington pairs have been considered to be the same as a single high-gain transistor.

Output triples are seldom used in modern audio amplifiers. The advent of modern high-gain, high-quality semiconductor devices has minimized their usefulness, with the few exceptions usually showing up in custom and esoteric designs. However, one of my goals in writing this book is to consolidate concepts and technologies, both old and new, which will aid the audio designer toward practical avenues of research. Research is not always motivated by concepts of "bigger, better, and faster." Often, the traits of practicality, expense, and application orientation are much better foundations to build on. Therefore, I believe it is appropriate to discuss OPS triples as a pathway for new experiments and/or research.

Referring to Figure 6.4, note that both triple OPS designs begin with a CF stage (that is, Q1, Q2, Q3, and Q4 in both diagrams). The only significant difference in the two topologies is that (a) utilizes a quasi-complementary output pair and (b) uses a complementary-symmetry output pair.

If you happen to be familiar with classic hi-fi design, you may recognize Figure 6.4(a) as the basic topology of the famous "Quad-303" quasi-complementary triple (some of the component values may not be the same). I set up a test circuit for this OPS design using MJ15003/MJ15004 complementary pairs, dual-polarity 55-volt rails, and several standard values of resistive dummy loads. V_{bias} was adjusted for lowest distortion and a 60-volt P-P sine wave signal was applied to the input. Open-loop distortion was good, measuring out at 0.141 percent at 8 ohms and 0.202 percent at 4 ohms. However, stability was very shaky. A lagging 212 degree output phase shift occurred at 4.6 MHz, causing a massive voltage gain peak of 11.25 (indicating that a very significant amount of positive feedback was being applied intrinsically). This condition would be almost certain to cause severe stability problems in a completed amplifier with the global NFB loop

closed. Keeping all other conditions the same, I tried the same test using 2SA1302/2SC3281 pairs. The circuit provided the same basic response, except the voltage gain peak occurred at 562 kHz.

Using identical circuit conditions, I tested the circuit of Figure 6.4(b) in the same manner. Using the MJ15003/MJ15004 pairs, the open-loop distortion measured 0.125 percent at 8 ohms and 0.194 percent at 4 ohms. A lagging 262 degree output phase shift occurred at 3.83 MHz with a voltage gain peak of 2.6. With a slightly lower than optimum setting of V_{bias} , the circuit breaks into self-sustaining oscillation.

There is no question that circuit stability and performance of both of these triplet designs could be greatly improved. These examples of circuit performance are not intended to illustrate optimum performance; I just wanted to provide a basic concept of triplet performance at its most fundamental level. Regarding stability in terms of fundamental design types, the establishment of good stability performance in an OPS triple is always going to be a tricky endeavor. In mathematical terms, the phase stability of an output triple becomes a three-pole polynomial (i.e., three capacitive semiconductor junctions in series), and this provides a very real possibility of turning into a high-power phase-shift oscillator without very careful design precautions.

OPS triples have a few advantages in comparison to the previously discussed OPS topologies. Since there are two stages of predriver transistors, both of which are CF designs, V_{bias} can be thermally tracked to the first predriver stage (that is, Q1 and Q2 in both illustrations of Figure 6.4). When properly designed, this first driver stage can remain almost cold due to its minimal power dissipation requirements, providing exceptionally good thermal stability.

Another advantage offered by triples is their improved large-signal linearity. Due to the OPS's being buffered by an additional current gain stage, there is less distortion resulting from beta droop. Beta droop will be discussed in greater depth later.

There is another characteristic of triples that could be considered an advantage depending on individual circumstances. Triples provide the best stability performance when constructed with low-beta transistors. This quality was very impor-

QUICK TIP

Remember, the local NFB loop of a CF design automatically provides thermal compensation for the output transistors. Providing Q3 through Q6 are mounted to the same heatsink, V_{bias} need only be thermally tracked to Q1 and Q2.

tant in days past when almost all high-voltage transistors were low-beta types, but it can still come in handy depending on your personal inventory. If you have a large quantity of older low-beta-power transistors, you may want to spend a few Saturday afternoons experimenting with some triple designs. Just remember to be close to the power off switch and keep a fire extinguisher handy!

Paralleled Output Stages

The most obvious and straightforward method of increasing the power output capability of any audio power amplifier is to parallel the output devices. Several methods of accomplishing this are illustrated in Figure 6.5.

In general terms, there are a few basic rules to paralleling BJT output devices. Most importantly, some form of degenerative feedback must be incorporated to ensure that each output device will share an even load of the output current. Emitter degeneration resistors, commonly called *RE resistors*, are universally used for this purpose. Typical values range from 0.1 to 1 ohm. The incorporation of RE resistors to aid in equal current sharing of the output devices is often called *ballasting*.

To understand how RE resistors accomplish their task, refer to Figure 6.5(a). Note transistors Q3 and Q5 are paralleled, utilizing 0.33-ohm RE resistors. Even though Q3 and Q5 are the same transistor type, the V_{be} characteristics will probably vary by some minor amount. For discussion purposes, assume the V_{be} of Q3 is 10 mV less than Q5. As a positive signal voltage is applied simultaneously to the bases of Q3 and Q5, Q3 will begin to conduct first. As positive current flow increases through the OPS in a disproportionate manner, RE1 begins to drop a higher voltage than RE3, because Q3 is conducting the majority of OPS current. When RE1's voltage drop exceeds the difference of the V_{be} mismatch (that is, 10 mV in this case), Q5 is forced to begin conduction because the sum of Q3's V_{be} drop and RE1's voltage drop will exceed Q5's V_{be} parameter. As positive OPS current continues to increase, the unequal V_{be} characteristics of Q3 and Q5 will be negated by the unequal voltage drops across RE1 and RE2, creating a near current balance condition. (Technically speaking, there will continue to be about 30 mA of current sharing offset in this example.)

RE resistors are also very valuable in providing some necessary thermal compensation for the output transistors. The principle of

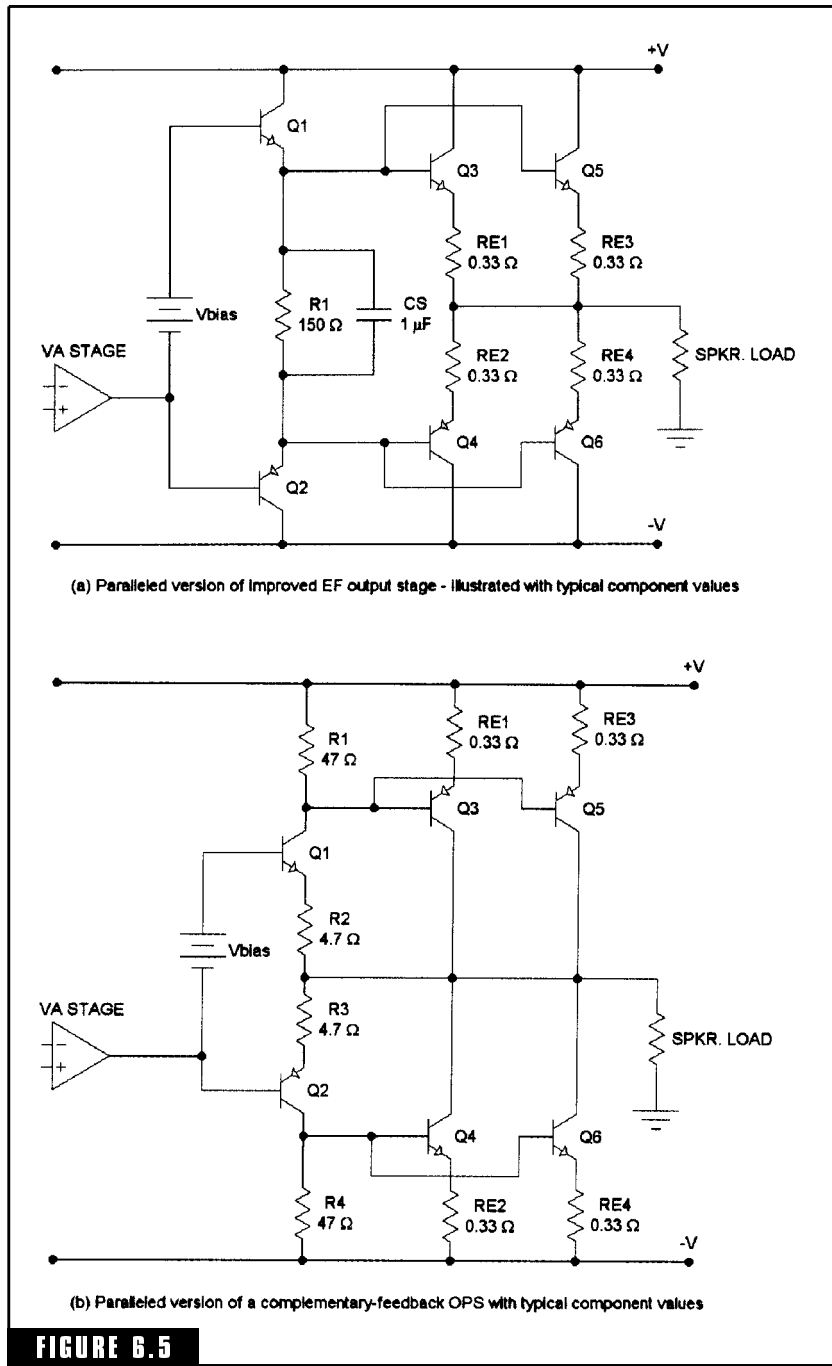

Examples of paralleling BJT output stages for higher-power applications.

operation in this respect is the same. If one output transistor begins to exhibit excessive leakage when heated, the excess leakage current will manifest itself as an increased voltage drop across the associated RE resistor and force the other output devices to assume a larger portion of the current load.

While on the subject of RE resistors, there are several common misconceptions regarding their function I would like to comment on. First, the resistance value of RE resistors has no relationship to crossover distortion. Crossover distortion is a constant, created from the nonconjugate nature of semiconductor junctions near the cutoff point. The effect of crossover distortion is affected by the setting of V_{bias} and the signal level applied to the output load. (Yes, that's correct! Crossover distortion decreases with output amplitude. The reason behind this will be explained later.) Increasing the resistance value of RE resistors does nothing to help crossover artifacts. Secondly, RE resistors are not instrumental in improving OPS linearity. While it is true that degenerative feedback improves linearity, the low-resistance values of RE resistors necessary for reasonable OPS efficiency reduce their linearizing contribution to negligible levels. It is much preferred to allow the global NFB to take care of linearizing the OPS rather than waste vast quantities of heat in RE resistors.

As shall be discussed in Chapter 8, RE resistors are very valuable in establishing current limit sense voltages (as used in the previously discussed class A amplifier of Figure 6.2(a)). Various resistance values of RE resistors are chosen to provide sense voltage levels appropriate for whatever type of protection circuit is desired. If it were not for this one function, virtually all RE resistance values could be established across the board at about 0.1 ohm.

In some paralleled OPS designs, base-stopper resistors are used in the base circuits of paralleled output transistors to improve stability and reduce the chance of RF oscillation. Base-stopper resistors are typically about 1 to 100 ohms in value, with typical values in the 2.2- to 10-ohm range. Don't confuse base-stopper resistors with resistors placed in the base circuits of single-pair output transistors (i.e., non-paralleled output transistor pairs). In this latter case, the resistors are used to increase the input impedance of the output devices, thus reducing loading distortion imposed on the VA. In contrast, the function of base-stopper resistors is to isolate the base capacitance of paralleled

output BJTs. For the most part, base-stopper resistors are not needed in BJT OPSs. Many designers incorporate them as an added safeguard of OPS stability, but their effectiveness in most designs is questionable. One of the most reliable high-power commercial designs that I am aware of utilizes five paralleled BJT output pairs without any base-stopper resistors. However, in the case of MOSFET OPSs, gate resistors in paralleled OPSs are an absolute necessity.

Going back to Figure 6.5, the basic EF and CF designs illustrated make up over 90 percent of all of the high-power OPS topologies incorporating BJT output devices. In comparing these circuits with the basic EF and CF circuits of Figure 6.3, you'll note the only differences are the additional output transistor pairs and the incorporation of RE resistors in the CF version.

Both OPS designs of Figure 6.5 are functional as illustrated. If MJ15003/MJ15004 transistors are used in the CF circuit of Figure 6.5(b), the performance and stability are excellent. The inherent local NFB loop provides excellent open-loop large-signal linearity (0.093 percent at 8 ohms) with safe load handling characteristics in the 150- to 200-watt RMS ranges.

A Summary of Class B Output Stage Characteristics

When we make the choice of leaving the realm of class A (which I think is a good one), we are immediately faced with the task of deciding on the best type of class B OPS design. So far, we have examined two basic types of EF designs [Figure 6.3(a) and 6.3(b)], the CF design [Figure 6.3(c)], the QC design [Figure 6.3(d)], “triple” designs (Figure 6.4), and the basic paralleled EF and CF designs (Figure 6.5).

The basic EF design of Figure 6.3(a) can be disregarded. It offers no advantages that I am aware of and does not provide the low switching distortion performance integral to the improved EF design of Figure 6.3(b). In the practical sense, the basic QC design of Figure 6.3(d) can be thought of as identical to an EF design with slightly increased distortion. I recommend avoiding triplet designs altogether unless you're very experienced with solving stability problems and have a parts inventory especially suited to triplet construction.

Paralleled OPS designs are a function of power requirements rather than a representation of design topology. With all things considered (i.e., reliability, cost, complexity, size, weight, etc.), my rule of thumb

regarding BJT output devices is to provide one complementary output pair for every 80 watts RMS of required power to a speaker load.

Therefore, the choice of the best OPS type boils down to a rather simple three-way decision—emitter follower, complementary feedback, or quasi-complementary. Depending on the desired power requirements, any of these topologies can be paralleled according to individual needs.

The advantages to the emitter-follower topology are as follows:

1. Excellent stability
2. Good distortion performance
3. Reduction of switching distortion
4. Lower crossover distortion at low power levels

The disadvantages to the emitter-follower topology are:

1. Poor V_{bias} stability under dynamic temperature variations
2. Higher idling power dissipation
3. Greater susceptibility to beta-droop nonlinearities

The advantages to the complementary-feedback topology are as follows:

1. Best open-loop linearity of any OPS design
2. Improved V_{bias} stability under dynamic temperature variations
3. Best large-signal linearity of any OPS design
4. Low idling power dissipation

The disadvantages to the complementary-feedback topology are:

1. No practical provision for the reduction of switching distortion
2. Some high-frequency instability artifacts, although generally not harmful

The advantage to the quasi-complementary topology is that it is less expensive than typical complementary-symmetry topologies. Its greatest disadvantage is slightly increased crossover distortion and distortion produced from stage nonlinearities (compared to EF topologies).

It seems that almost everyone who is experienced at building audio power amplifiers develops a personal fondness for some specific output design. This is expected, and the personal touch is what provides much of the variety and pleasure in accomplishment. In the practical and realistic sense, any of the three primary OPS choices will provide excellent results in a well-designed amplifier. It is true that a CF OPS will provide slightly improved distortion performance, but the difference is in the thousandths of a percent and can be detected only with instrumentation. It is also true that an EF OPS will produce many fewer crossover artifacts at low-power levels, but this is also many times lower than can be detected by the human ear—even at the lowest-power output levels.

It can be accepted as an axiom that there are bad-sounding audio power amplifiers. My personal research, along with supportive research from many other audio design personnel, suggests that these bad-sounding amplifiers are not a result of the class of operation or the choice of OPS design. The *real* problem is often the poor performance of the stages leading up to the OPS—that is, the input stage and VA stage. Since we have discovered how to work the bugs out of these areas, there isn't any reason that you should not be able to construct power amplifiers with excellent sonic performance utilizing any of the three OPS types listed previously.

MOSFET Class B Output Stages

Power MOSFETs applicable for use in audio amplifier OPSs first hit the commercial marketplace in the late 1970s. It had been recognized that MOSFETs could provide significant advantages over BJTs in high-power audio applications, but the earliest attempts at utilizing vertical DMOS were not very successful. This was primarily due to the fact that good complementary devices were not available. In 1977, Hitachi launched a new type of planar DMOS family, commonly referred to today as *lateral MOSFETs*, available in the form of complementary pairs from the onset. To the best of my knowledge, lateral MOSFETs are the only power semiconductor devices that have ever been manufactured expressly for audio amplifier applications.

All MOSFETs used in audio power applications are enhancement mode types, meaning the drain-source current will not flow until an

enhancement voltage is applied between the gate and source leads. They can be thought of as analogous to transistors in this respect, even though the principle of operation is different. This characteristic allows for an easy marriage of lateral MOSFETs into preexisting BJT OPS designs. Further information on the physics and basic operational principles of MOSFETs can be found in any basic electronics textbook.

Since the advent of lateral MOSFETs, there has been continued growth in vertical DMOS (that is, VMOS or HEXFET) families, with modern complementary devices readily available. Vertical DMOS was originally intended for high-power switching applications, but some devices lend themselves well to linear circuits. For example, I have discovered that the IRF 640/ IRF 9640 pairs are fairly good replacements for lateral MOSFETs in some OPS designs, even though they are not considered complementary.

The Debate Over MOSFET versus BJT Outputs

I suppose a large part of the exceptional vigor that has always been a part of the audio community is a result of very high levels of audiophile adrenaline brought on by continual heated controversy. Anyone who has been involved with audio for more than a few months will agree that I'm not exaggerating. Don't misunderstand me—I love controversy! It's refreshing to be involved in a field in which complacency is seldom encountered.

Like most debates, there is some truth to both sides of the MOSFET versus BJT argument, and there's a lot of untruth bandied about by members from both sides. Lateral MOSFETs offer some significant advantages over BJTs but not without some drawbacks. The primary advantages to lateral MOSFETs in power amplifier OPSs are as follows:

1. Lateral MOSFETs go through a transition from positive to negative temperature coefficient characteristics at very low drain currents, typically 200 mA or lower. In other words, lateral MOSFETs start out with a positive temperature coefficient like BJTs, but as soon as the drain current becomes significant (i.e., greater than about 200 mA), lateral MOSFETs take on a negative temperature coefficient, automatically limiting drain current as temperature increases. This is an ideal characteristic for audio power applications in that it eliminates many complications arising in BJT OPSs relating to temperature. First,

Vbias is no longer required to thermally track the output devices. This means the elimination of the bias transistor (i.e., the amplified diode circuit) and any concerns of thermal tracking accuracy. Second, it reduces various mechanical and layout problems regarding heatsink placement for accurate thermal tracking. If it is more convenient, lateral MOSFET output devices do not even need to be placed on the same heatsink since thermal tracking is no longer necessary. Third, it is no longer necessary to incorporate high-wattage source resistors (i.e., analogous to RE resistors in BJT circuits) for the purpose of ensuring current load-sharing of the output devices. The negative temperature coefficient of lateral MOSFETs automatically corrects for current imbalances.

2. Lateral MOSFETs are immune to secondary breakdown. Not only does this characteristic improve reliability expectations but it also does away with the need for complex BJT overload protection circuits. Protection circuits can be reduced to simple VI limiters.

3. Lateral MOSFETs do not exhibit any characteristic analogous to beta droop effects in BJT power transistors. This characteristic eliminates one of the three major distortion mechanisms inherent to OPSs.

4. Lateral MOSFETs are definitely more rugged and forgiving. The 2SK1058/2SJ162 devices I recommend for the MOSFET projects in this book are almost literally indestructible. They are intrinsically diode protected against static discharge, immune to secondary breakdown, and automatically current limiting. (Ordinary fast-blow fuses will actually protect lateral MOSFETs from overcurrent damage. In contrast, BJTs will protect a fuse almost every time.) To put it bluntly, it is almost impossible to destroy one of these devices by accident. The reliability of any power amplifier incorporating a lateral MOSFET OPS will be vastly superior to an identical design utilizing BJTs for output devices, *even if the BJT OPS is extensively protected*.

5. Lateral MOSFETs, like all MOSFET devices, are voltage devices. That is, they do not require any drive current other than that which is needed to feed their relatively large gate capacitances. Consequently, the loading effect of a MOSFET OPS on the VA is minimal. This characteristic helps to reduce (or eliminate) VA loading distortion and helps to simplify VA design requirements.

6. There are no charge-storage effects in lateral MOSFETs. Therefore, they are immune to switching distortion.

7. In the rare cases of failure, MOSFETs usually fail “soft,” meaning the gate short circuits to the source. In worst-case scenarios, the channel will short, but either way, it is very seldom that an expired MOSFET will cause a chain of destruction back to prior stages (this type of feedback destruction is called *collateral destruction*).

8. The Vbias accuracy required for optimal lateral MOSFET OPS crossover distortion performance is much less critical than for comparable BJT OPSs. In sum, this means a MOSFET OPS will be easier to set up and will maintain better long-term Vbias stability.

9. Lateral MOSFETs have a much wider bandwidth than power BJTs. They are capable of faster switching action than BJTs due to the absence of charge-holding minority carriers, which is the reason MOSFETs are immune to switching distortion. However, it is debatable whether or not a wider bandwidth is of much advantage in real-world amplifier design. In either case, the wider bandwidth helps to keep the amplifier compensation from being very fussy.

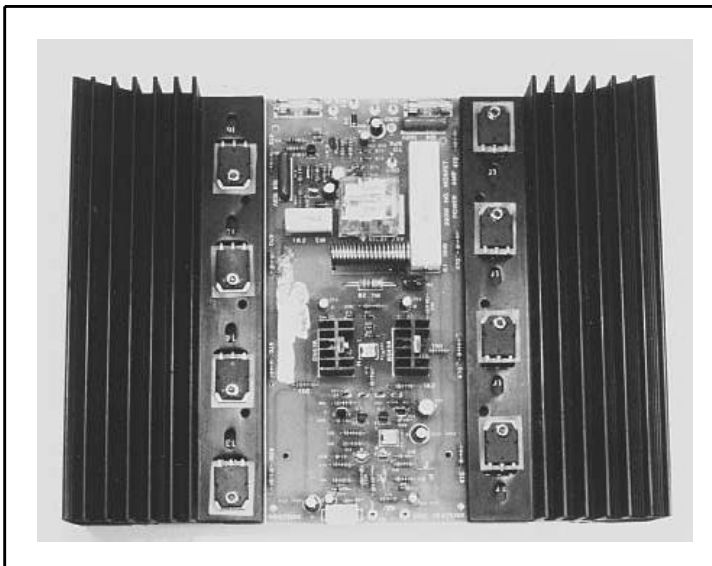

This quality 300-watt MOSFET amplifier does not require thermal tracking for optimum OPS performance. This feature allows the output devices to be mounted to separate heatsinks for improved heat dissipation.

While all of the aforementioned advantages of lateral MOSFETs sound pretty good, lateral MOSFETs are not as perfect as many promoters would have you to believe. There is a definite downside to MOSFETs due to the following disadvantages:

1. Lateral MOSFETs require a higher bias current than comparable BJT devices for optimum performance. This leads to slightly poorer OPS efficiency, but this is usually considered a minor issue. A rule-of-thumb estimate of additional power loss compared to BJT OPSs is about 5 watts per 100 (i.e., for every 100 watts supplied to the speaker load, a MOSFET OPS will waste an additional 5 watts). Lateral MOSFETs also have a higher *on* resistance as compared to the saturation impedance of a BJT. This characteristic manifests itself as increased power dissipation when driving hard loads with only single output pairs. However, with paralleled MOSFET OPSs, the effect becomes relatively insignificant.

2. The V_{gs} parameters of lateral MOSFETs can be somewhat higher than V_{be} parameters for BJTs (VMOS has a substantially higher V_{gs} parameter, typically around 4 to 6 volts). When the higher V_{gs} parameter is combined with the higher *on* channel resistance described previously, the combined effect is a decrease in maximum output power of about 5 to 7 percent compared to BJT OPSs utilizing the same rail voltages.

3. Lateral MOSFET transconductance is much lower than comparable BJT devices, which is equivalent to greatly reduced linearity. This statement needs a few words of explanation. Many promoters equate lateral MOSFET linearity with that of BJTs, but they are not comparing apples with apples. Since MOSFET transconductance is so much lower, the only appropriate way to make a comparison is to degenerate a BJT until its transconductance value is approximately equal to that of a lateral MOSFET. When this is accomplished, it becomes clear that BJTs are far superior in linearity compared to lateral MOSFETs.

4. Lateral MOSFETs are much more susceptible to destructive parasitic oscillations. Fortunately, this condition is easily remedied by the incorporation of gate-stopper resistors (i.e., analogous to base-stopper resistors for BJTs).

5. The cost of lateral MOSFETs can be as much as three times the cost of comparable BJTs.

In addition to the aforementioned pros and cons, there are a few ambiguities involved in the MOSFET versus BJT debate. Some argue that the class B conduction characteristics of MOSFETs are not as good as BJTs (that is, the nonconjugate nature of complementary MOSFETs is worse than that of complementary BJTs), resulting in increased crossover distortion in MOSFET amplifiers. Opponents point out that the bias setting in BJT amplifiers is much more critical (which it is) and almost impossible to thermally track with the kind of accuracy that will keep BJT crossover distortion at the optimum null throughout dynamic temperature variations. Therefore, they claim MOSFET crossover distortion is less on the average. I would agree with the MOSFET proponents on this one but not necessarily for the same reasons. In my experience, it is possible to obtain lower levels of crossover distortion with BJT outputs. But unless you like to fiddle with your amplifier on a regular basis, the optimum bias setting will probably drift to the point of exceeding MOSFET crossover levels in a relatively short time.

MOSFET amplifiers have not dominated the high-quality professional market as could be expected due to a variety of marketing considerations. The present trend is toward the most power in the least size and weight package. MOSFET OPSs are not the best choice in this respect due to their poorer efficiency in comparison to BJTs. Manufacturers are also very sensitive to component costs, with the cost of lateral MOSFETs coming out to around two to three times as much as comparable BJTs. This is all very unfortunate because high-power professional audio is where lateral MOSFETs really shine.

Finally, I'd like to add one final point regarding lateral MOSFET evaluation—lateral MOSFETs do not sound like vacuum tubes. This concept was based on the singular assumption that since MOSFETs and vacuum tubes are both transconductance devices, they would probably sound similar. To the best of my knowledge, there isn't any sonic comparison at all that can be made between vacuum tubes and MOSFETs, with the exception of the same comparisons that could be made with BJTs.

MOSFET Output Stage Configurations

Since MOSFETs behave very much like BJTs in the respect of fundamental operation, it is not surprising the MOSFET OPSs look very much like BJT OPSs. Figure 6.6 illustrates the common variety of MOSFET OPS configurations.

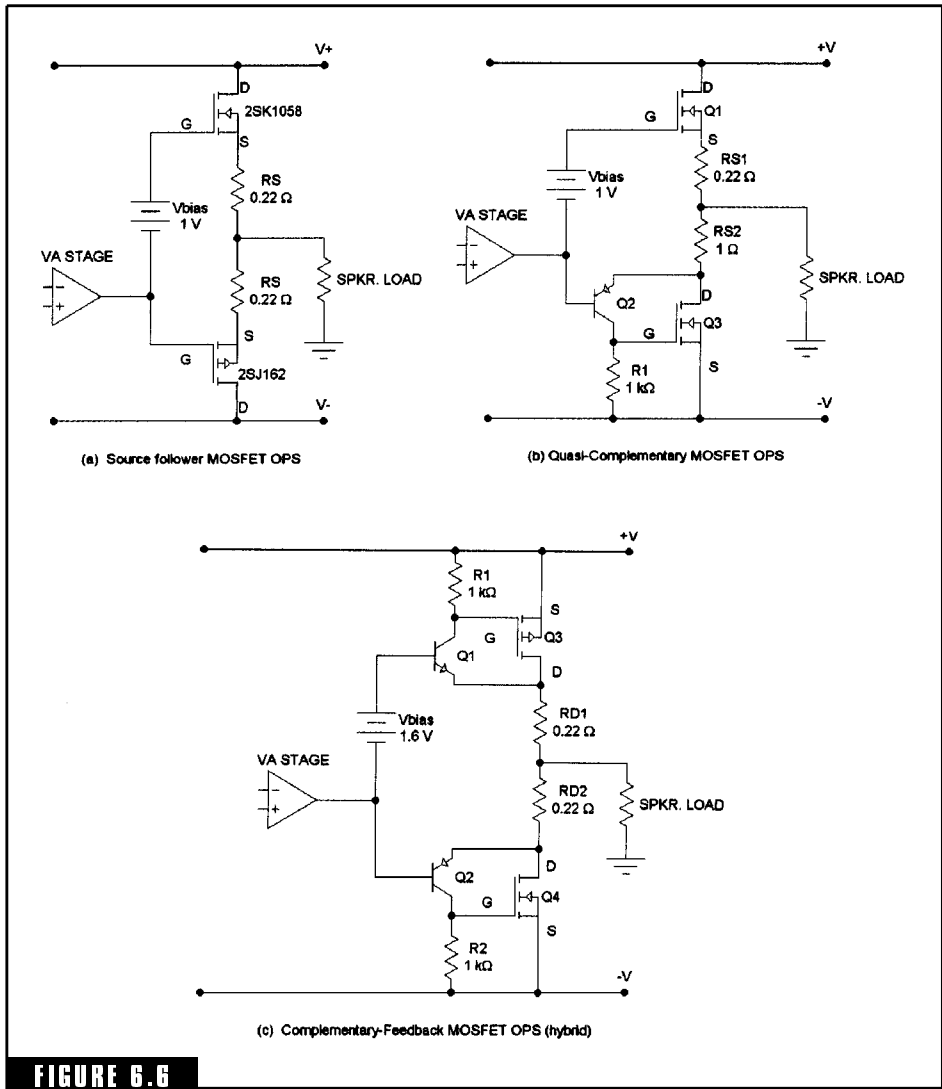

FIGURE 6.6 Examples of MOSFET OPSs with typical component values.

Figure 6.6 shows a single-pair MOSFET source-follower OPS. This configuration correlates to the emitter-follower BJT configuration illustrated in Figure 6.3(a), with the exception that predriver transistors are not necessary. Figure 6.6 provides lead identification with typical component values. I included the Hitachi lateral MOSFET part numbers in this diagram for reference purposes. These are the only lat-

eral MOSFET devices I recommend for all of the MOSFET projects in this book, unless equivalent replacements are available in your area.

The source resistors (RS) shown in Figure 6.6(a) are not needed but are likely to be included in many OPS designs for the purpose of providing current sensing voltages for protection networks. The open-loop large-signal distortion of this circuit is poorer than the comparable BJT circuit of

Since the early 1990s, several U.K. manufacturers, namely, Profusion and Semelab, have begun to provide Hitachi-equivalent replacements for lateral MOSFETs (together with some of the discontinued Hitachi devices, such as the famous 2SK134/2SJ49 devices). I hope to see multisource availability of lateral MOSFETs improve in the near future.

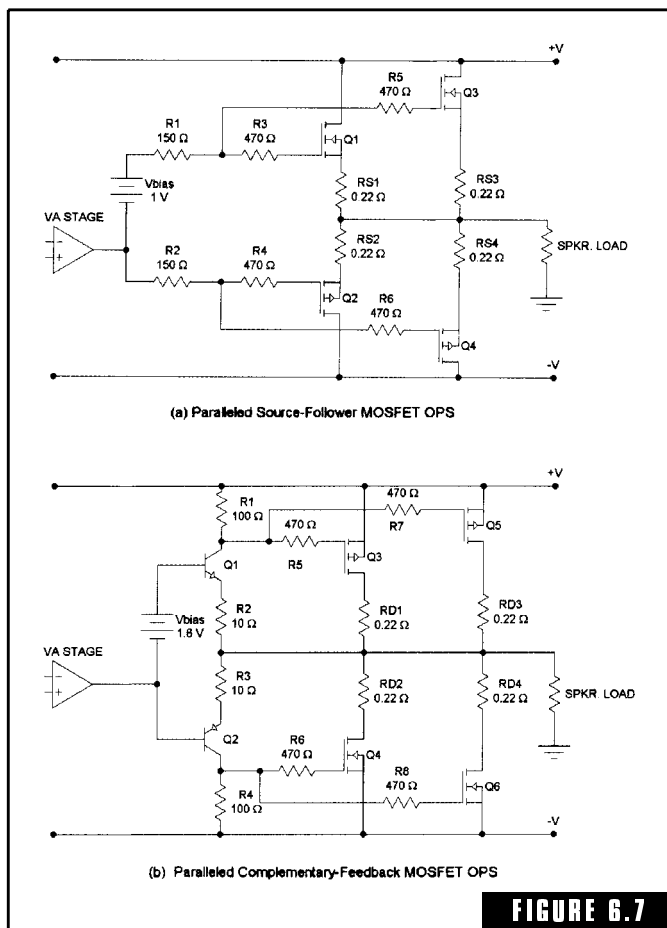

FIGURE 6.7

Examples of MOSFET OPSs with typical component values.

Figure 6.3(a), which is to be expected due to the much lower transconductance. Figure 6.6(a) measured out at 0.52 percent at 8 ohms and 0.581 percent at 4 ohms. In comparison, Figure 6.3(a) measured 0.133 percent and 0.145 percent, respectively, indicating about a 4-to-1 degradation of large-signal nonlinearity of the MOSFET OPS. This is not as bad as it seems, however. The larger portion of the MOSFET nonlinearity is due to poorer transconductance, which places the frequency content of the increased distortion in the low-frequency realm where it can be effectively reduced by the global NFB.

Figure 6.6(b) illustrates a method of configuring a quasi-complementary MOSFET OPS. I'm not going to dwell on this circuit too long because it is one of those good ideas that didn't turn out too well in practice. The linearity is extremely poor due to the large transconductance offset between the upper MOSFET "single" device and the lower hybrid complementary-feedback pair. RS2 can be increased slightly to reduce this effect, but linearity then becomes very load dependent. This circuit configuration was developed at a time when complementary MOSFETs were not readily available, but it has little practical application in modern audio power amplifiers.

Figure 6.6(c) illustrates a MOSFET complementary-feedback configuration. Again, this circuit can be compared with its BJT counterpart of Figure 6.3(c). Many audiophiles call this a *hybrid OPS*, referring to the marriage of BJT and MOSFET devices within a single OPS. The linearity of this configuration is much better than the source-follower topology illustrated in Figure 6.6(a), providing large-signal distortion performance of 0.059 percent at 8 ohms and 0.063 percent at 4 ohms—an approximate tenfold improvement. However, it is still about four times worse than the equivalent CF BJT circuit of Figure 6.3(c). The way this all comes out in a completed amplifier with global NFB is an increase of MOSFET OPS distortion of about 0.003 percent compared to BJT equivalents. In other words, a top-notch optimally adjusted BJT amplifier may achieve 1-kHz distortion performance in the realm of 0.001 percent. In contrast, an identical MOSFET amplifier may measure out to around 0.004 percent.

Figure 6.7(a) shows how a source-follower MOSFET OPS can be paralleled for higher output power. Gate resistors R3, R4, R5, and R6 are the typical values for 2SK1058/2SJ162 devices. R1 and R2 provide

some additional stabilizing isolation between the relatively high gate capacitance of the lateral MOSFET stage and the VA. There is little variation in the open-loop distortion performance of this circuit and the OPS of Figure 6.6(a), with the measured statistics coming out to 0.508 percent at 8 ohms and 0.54 percent at 4 ohms.

The basic MOSFET CF topology can be paralleled as illustrated in Figure 6.7(b), with some modifications incorporated to improve stability characteristics. The same two-pole stability characteristic of BJT CF stages is also inherent to hybrid MOSFET CF stages, with the further aggravation of the high MOSFET gate capacitance added to the problem. Note that the BJT predriver stage is set to a voltage gain of 10, providing a sort of buffer against stability problems resulting from the phase-shifted MOSFET output signal being fed back to a high-gain BJT stage. With the component values shown, stability is very good, with a negligible gain peak at about 8.9 MHz. With the gate resistors removed, a very high voltage gain peak occurs at 21 MHz accompanied by some small parasitic oscillations. When the predriver voltage gain is increased to 100 (that is, R2 and R3 reduced to 1 ohm) and the gate resistors omitted, severe instability results. (I provided these last few comments to provide a general idea of how the circuit performs.)

Even with the reduction of predriver voltage gain, the circuit of Figure 6.7(b) provides good distortion performance. With the component values illustrated, the open-loop large-signal distortion comes out to about 0.123 percent at 8 ohms and 0.126 percent at 4 ohms. Note how the distortion only increases by about 0.003 percent when driving a 4-ohm load compared to an 8-ohm load. A comparable BJT OPS would have shown a much greater open-loop nonlinearity increase at 4 ohms due to the effect of beta droop (typically about 20 to 30 percent degradation in linearity). Consequently, in situations where a top-notch BJT amplifier is required to drive 4-ohm loads, its distortion performance may come out nearly identical to a comparable MOSFET amplifier.

For optimum performance, transistors Q1 and Q2 of Figure 6.7(b) should be thermally tracked with a “V_{be} multiplier” (i.e., amplified diode) circuit. This is much less critical than in OPSs with BJT output devices, however. As stated earlier, MOSFETs are not as sensitive to precise bias requirements as BJTs. In addition, with the component values shown, Q1 and Q2 will only dissipate about 3 to 4 watts using dual 85-volt rails. Because there is no DC current load on the

collectors of Q1 and Q2, the thermal-tracking problem is reduced to the simple task of stabilizing the DC parameters of Q1 and Q2 to the relatively broad requirements of lateral MOSFETs.

The topology illustrated in Figure 6.7(b), in my opinion, is about the closest thing currently available to the ideal OPS. I consider the few thousandths of a percent increase in distortion (compared to BJT OPSs) to be negligible compared to the enormous benefits of the elimination of critical thermal tracking, immunity to secondary breakdown, and unparalleled ruggedness.

It is one thing to sit in an air-conditioned lab and fiddle with an amplifier under ideal conditions, trying to obtain the proverbial straight wire with gain. It is an entirely different thing to take an amplifier out on the road, exposing it to all kinds of environmental and electrical extremities, dropping it a few times in the process, and using it for weight ballast to keep an equipment trailer from turning over at 65 miles per hour. Domestic hi-fi falls somewhere in between these two extremes, having to survive the rigors of teething dogs, curious 5-year-olds, and well-meaning mothers who occasionally see the need to wash down a power amplifier with plenty of water and heavy-duty spray cleaner.

With all things considered, I believe there is a practical and common-sense method of choosing between MOSFETs and BJTs in OPS designs. For medium-power domestic hi-fi, musical instrument amplifiers, and stage-monitoring applications, BJT OPSs are a good choice. For medium- to high-power domestic audiophile hi-fi applications, it becomes a coin toss between MOSFETs and BJTs. For high-power professional and public address applications, there is no question that MOSFETs offer improved reliability and ruggedness performance. Regardless of your personal leanings, I can promise that no one is going to hear a 0.003 percent difference in distortion performance.

IGBT Output Stages

An *insulated gate bipolar transistor* (IGBT) is a relatively new device on the commercial market. They are publicized as having the high input impedance of a MOSFET with the low saturation voltage of bipolar devices. This appears to be an accurate performance descrip-

tion, but this is not necessarily an ideal situation for an output device intended for use in audio power amplifiers.

IGBTs are plagued with the same problem as most newly offered semiconductor families—that is, the lack of complementary devices. At present, Toshiba's GT20D201/GT20D101 complementary devices are probably the most popular for incorporation into audio power amplifiers.

There are some disappointing disadvantages to IGBTs for audio amplifier applications. First, they are subject to the same ills as BJTs regarding thermal characteristics. Thermal tracking is just as touchy and secondary breakdown is the continuous sword of Damocles. Also, the combination of high gate capacitance coupled with a low-voltage, hard turn-on characteristic does not sound promising from a stability perspective. In reality, the ideal solid-state device for high-power audio applications would tend to be more of an opposite configuration: the utilization of a bipolar transistor to drive a MOSFET.

IGBTs were not designed with audio amplifiers as their primary marketplace. Consequently, for the time being at least, it is probably prudent for the audiophile to leave them to their comfortable positions in switching mode power supplies and switching regulators. However, if you would like to build a modern IGBT audio power amplifier, a good 90-watt RMS design is provided in the book entitled *High-end Audio Equipment* (ISBN: 0-905705-40-8) available from Old Colony Sound Lab (address and telephone number are listed in Appendix D).

This page intentionally left blank.

Stability, Distortion, and Performance

In some ways, audio power amplifiers are a contradiction in terms. Our goal is to construct ultralinear circuits for virtually distortion-free reproduction of music signals. But we must design amplifiers so that they will function accurately within an environment of approximately 100 dB of signal-level variation, 500 percent load impedance versatility, 1000 percent load reactance variations, and 300 percent temperature climbs, while simultaneously providing massive current outputs throughout a 9-octave bandwidth. Perhaps we audiophiles should consider helping NASA with their outer-space problems when we get our sonic problems licked!

Due to the extreme conditions of gain and operational demand, the most serious problem the amplifier builder faces is stability. Virtually all other problems can be safely dealt with and corrected as needed, but stability is insidious, appearing in many disguises and ready to destroy all of our hard work before we even know anything is wrong. High-frequency oscillations can be above the range of 20-MHz oscilloscopes; they can circulate through a single transistor stage or bounce around on power supply rails, only showing themselves in the form of increased distortion until pssssttt—and a silent puff of smoke provides the eulogy.

Destructive instability is only one kind of instability. We must also be concerned with V_{bias} stability in reference to temperature changes,

performance stability relative to component drift, and individual stage stability before we close the global NFB loop. Stability, distortion mechanisms, and performance are all closely related, so we will turn our attention toward these critical concerns in greater depth throughout this chapter.

Bias Generator Stability

The *bias generator* is the circuit that maintains the optimum V_{bias} voltage in a class B amplifier. So far, we have only examined the theoretical assumption that such a circuit exists and that it is adjustable, accurate, and stable.

In the earliest class B solid-state amplifiers, the bias generator consisted of two or more forward-biased series diodes designed to drop approximately the same voltage as required to compensate for the V_{be} drops of the OPS. These diodes were usually mounted to the OPS heatsink so that their temperature would equal the temperature of the output devices. As temperature increased, it was hoped that the forward voltage drop of the diodes would decrease by about the same amount as the V_{be} drops of the output transistors, thereby providing accurate temperature compensation. This system worked well enough to keep the output transistors from going into thermal runaway, but that's about all that can be said for it. In reality, the temperature characteristics of diodes do not match very well with transistor base-emitter junctions. Today, I know of only one manufacturer that still uses diodes for generating V_{bias} —the distortion performance of these amplifiers testifies that a better system is needed.

Various other devices have been incorporated to provide an accurate V_{bias} . These include thermistors, NTC resistors, and even combinations of resistors, silicon diodes, and germanium diodes. None of these methods provided accurate thermal tracking. The problem lies in the nonlinear manner in which leakage and temperature relate to each other in a base-emitter junction. The only practical method of emulating the nonlinear temperature-to- V_{be} characteristics of a transistor is with another transistor. Thus, the “amplified diode” was born!

Figure 7.1 provides three bias generator circuits utilizing the amplified diode principle. Figure 7.1(a) illustrates the simplest form of an

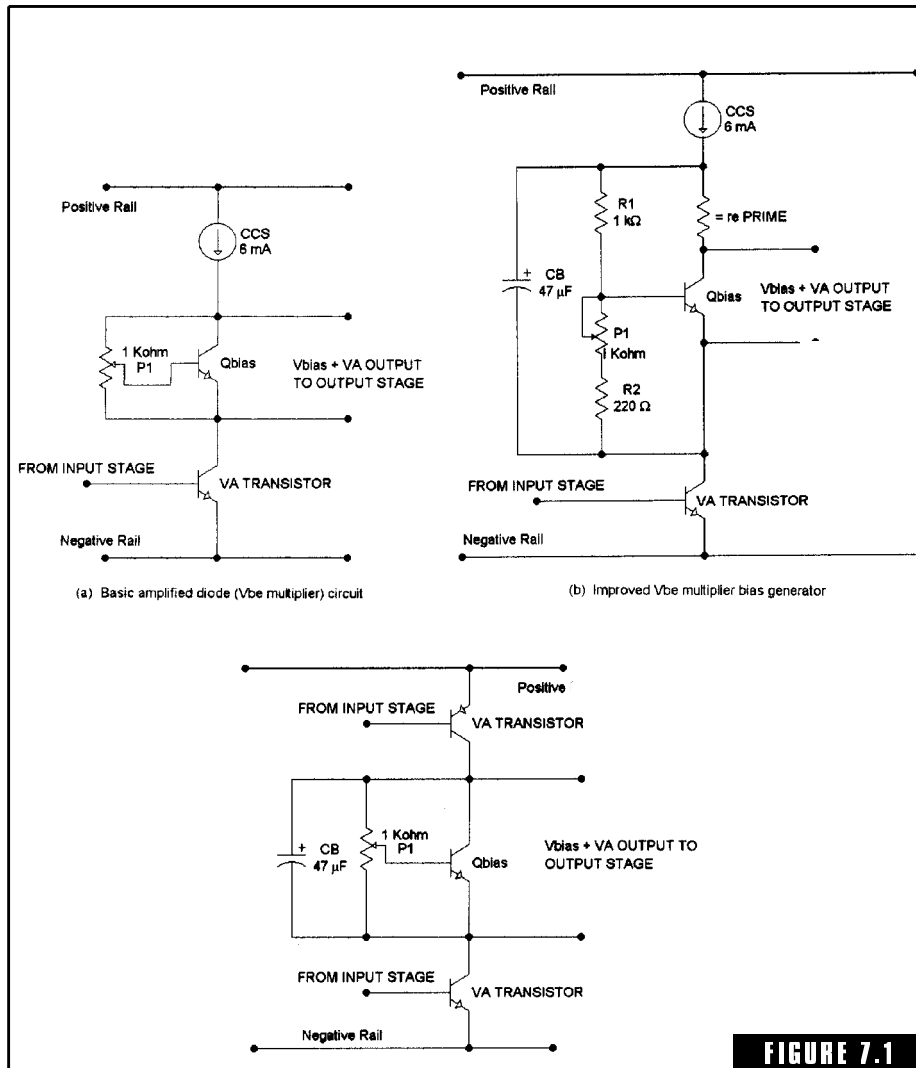

Three versions of bias generator circuits.

amplified diode circuit (commonly referred to as a *Vbe multiplier*). As shown, the bias generator for a class B OPS is virtually always placed in the output circuit of the VA stage, with Q_{bias} physically mounted to the heatsink or device requiring thermal tracking. Q_{bias} is in series with the constant current source (CCS), which makes up the active load for the VA transistor. The quiescent current of the VA output (provided

by CCS) creates a voltage drop across the 1-k Ω potentiometer P1. The polarities are such that Qbias is forward biased to some extent, depending on the setting of P1. As P1 is adjusted from one extreme to the other, the collector-to-emitter impedance of Qbias will change proportional to the degree of forward bias it receives. Since Qbias's collector-emitter impedance is much lower than the resistance value of P1, Qbias dominates the voltage drop. This arrangement provides a very stabilized, accurately adjustable bias voltage that will vary with temperature *according to the Vbe of Qbias*. The bottom-line result is that we have an adjustable bias generator that will provide an almost perfect emulation of nonlinear Vbe temperature characteristics.

There are some improvements that can be made to the basic amplified diode circuit of Figure 7.1(a). (After all, what fun is a circuit if we can't figure out some way to make it more complicated?) Figure 7.1(b) illustrates how a capacitor (CB) can be placed across the bias circuit to improve its rail rejection characteristics. CB also provides some filtering of high-frequency distortion, primarily crossover artifacts. Note that P1 has been reconfigured as a rheostat and placed entirely in the base-emitter loop of Qbias. This is a protection scheme. Most potentiometers fail by losing conductivity to the wiper arm (i.e., through dirt contamination or corrosion). Referring to Figure 7.1(a), note that if the wiper arm opened in this circuit, Qbias would cut off, and the Vbias applied to the OPS would increase to about 6 volts. This condition might not be readily detectable, since the OPS would simply be placed in class A mode. Without adequate SOAR and thermal shut-down protection, the output devices would rapidly overheat and probably be destroyed. This is obviously one of those funny little quirks we would like to avoid if possible. In the circuit of Figure 7.1(b), an open wiper arm would decrease the bias voltage, resulting only in an increase of crossover distortion. R1 and R2 of Figure 7.1(b) are installed to place P1 in its most effective control range, thereby providing greater sensitivity of adjustment.

All bipolar transistors have an integral current-dependent emitter impedance referred to as *re prime*. The calculation of *re prime* is as follows:

$$re' = \frac{25}{I_c \text{ (milliamps)}}$$

Re prime manifests itself as small V_{bias} changes brought on by power supply rail variations and small current variations through Q_{bias} relevant to temperature. These effects are not part of the V_{be} temperature emulation desired from a bias generator. To negate the effects of re prime, a resistor can be placed in the collector circuit of Q_{bias} to provide a slight modification to the voltage drop across P1. The small voltage drop across resistor re prime will cause a small increase in voltage drop across P1, providing a slight increase in the V_{be} of Q_{bias} , and effectively neutralizing the effect of re prime. The value of this resistor, illustrated as re prime in Figure 7.1(b), is roughly five times the calculated value of Q_{bias} 's re prime. For example, using the values given in Figure 7.1(b), the 6-mA current flow provided by CCS causes re prime to come out to about 4.1 ohms. Multiplying this value by 5 indicates the desired value of resistor re prime to be about 20.5 ohms. An 18-ohm or 22-ohm resistor would function nicely for this purpose.

Figure 7.1(c) illustrates a bias generator adapted for a mirror-image topology. For the sake of clarity, the cascode transistors and current limit circuits have been left out of the VA stage. The nature of a mirror-image topology is such that the quiescent current flow through the VA output is much higher than in typical VA stages. Therefore, the value of re prime internal to Q_{bias} drops to a negligible value, and resistor re prime, as shown in Figure 7.1(b), is no longer needed. It would be preferable to reconfigure the base bias circuit of Figure 7.1(c) to be the same as shown in Figure 7.1(b), since the OPS would still be vulnerable to an overdrive condition if the wiper arm of P1 opened.

Some amplifier designs isolate the printed circuit board from the physical location of the OPS heatsink(s). This requires the use of point-to-point wiring to connect the output devices mounted to the heatsink with the printed circuit board. Point-to-point wiring is not the most desirable system of connecting high-gain electronics to high-power output devices, but in some cases, it is unavoidable.

Note: This method should be avoided at all costs if the output devices are lateral MOSFETs.

As a consequence, many Q_{bias} transistors are connected to the printed circuit board by a generous length of insulated stranded wire, providing

for the distinct possibility of low-level oscillations at the amplifier output as a direct result of wiring capacitance from the bias generator. If the Q_{bias} transistor must be point-to-point wired in such a manner, it is best to keep the wire length at a minimum and carefully avoid running the wires close to high-current rails and sources of high EMI radiation (such as power supply transformers).

Thermal Delays

The only catch to our near-perfect amplified diode circuit is that Q_{bias} must be mounted to the heatsink or predriver transistor so that its temperature will match the temperature of the devices that are being compensated for. Even with this accomplished, there will be unfortunate thermal delays involved.

The variable that needs to be temperature compensated is the base-emitter junction of the output transistors or predriver transistors (depending on the OPS configuration). Unfortunately, the junction temperatures of power transistors must be thermally conducted to the transistor casing. This takes time! Then, the transistor casing must thermally conduct its temperature to the heatsink. More time! Finally, the temperature of the heatsink is thermally coupled to Q_{bias} , and temperature compensation is afforded. However, the actual junction temperature internal to the power transistors could be radically different. In some amplifier designs, this thermal delay could last for several minutes.

Frankly, it amazes me that semiconductor manufacturers have not seen fit to install temperature-sensing devices internally within various types of power devices. Thermal compensating delays could be avoided entirely because the junction temperatures could be directly monitored. Professional audio is not the only field that would benefit from such an improvement.

There is no question that thermal delays cause unnecessarily excessive crossover distortion until temperature stability is attained. Fortunately, in the practical sense, these delays cause fewer problems than one might expect. For example, the worst-case scenario for producing high levels of crossover distortion from thermal-tracking errors would be to apply power to a cold power amplifier and operate it at full volume. This condition would cause the junction temperatures of the power devices to heat rapidly, producing the largest thermal error pos-

sible. However, due to the nonlinear characteristics of the human ear, crossover distortion could not be heard at full-volume levels. Naturally, if a cold power amplifier were started up at low volume levels, thermal errors would be much less, hopefully maintaining crossover distortion below detectable levels.

Thermal delays can be reduced by physically mounting the Qbias transistor directly to one of the output transistor or predriver transistor cases.

This kind of mechanical construction is somewhat unsightly, and some amplifier builders would rather put up with longer thermal delays than do such violence to the amplifier aesthetics. That, of course, is an entirely personal decision.

Output Stage Stability

OPS stability can be viewed from two major perspectives: internal stability and external stability. Internal stability is descriptive of the OPS's stand-alone stability characteristics. In other words, internal stability reflects the OPS's ability to remain stable under all varieties of biasing and resistive output loading. In contrast, external stability defines how well an OPS can cope with all varieties of reactive and adverse loading conditions. Let us begin by considering internal stability characteristics of the major OPS topologies.

Internal OPS Stability

Figure 7.2(a) illustrates a test circuit for analyzing the internal stability of a paralleled emitter-follower OPS. MJ15003/MJ15004 pairs were used throughout. Power amplifier stability is best analyzed using square waves as the signal source, representing the worst-case test for the detection of ringing, parasitic oscillations, and overshoot. Observe the oscillogram (7.2b) for the OPS of Figure 7.2(a). This illustrates the excellent stability characteristics inherent to a typical EF OPS, showing no signs of ringing or any other beginnings of instability. The small spikes on the negative excursions are due to the small internal capacitance of the transistors.

Remember, Qbias

QUICK TIP
tracks the temperature of the output transistors if the OPS is an EF design. In CF OPS designs, the temperature of one of the predriver transistors is tracked.

of internal instability, the unity voltage gain extends well beyond the required bandwidth, and the phase shift is minimal at 100 MHz. If the OPS of Figure 7.2(a) were to be incorporated into an amplifier, the amplifier's compensation factor should cause the output signal to drop below unity gain at a frequency well below 100 MHz.

Figure 7.3(a) illustrates a similar test circuit to analyze the internal stability characteristics of a CF OPS. I purposely chose transistors poorly suited to a CF design (that is, 2SA1302/2SC3281 pairs) as a means of demonstrating the stability concerns of CF stages in general. The oscillogram [Figure 7.3(b)] clearly indicates the presence of some internal stability problems. The large 10-volt spikes reveal that the internal capacitance of the transistors is relatively high, with the damped oscillations indicative of internal instability. If the circuit of Figure 7.3(a) were incorporated into a power amplifier without any stability

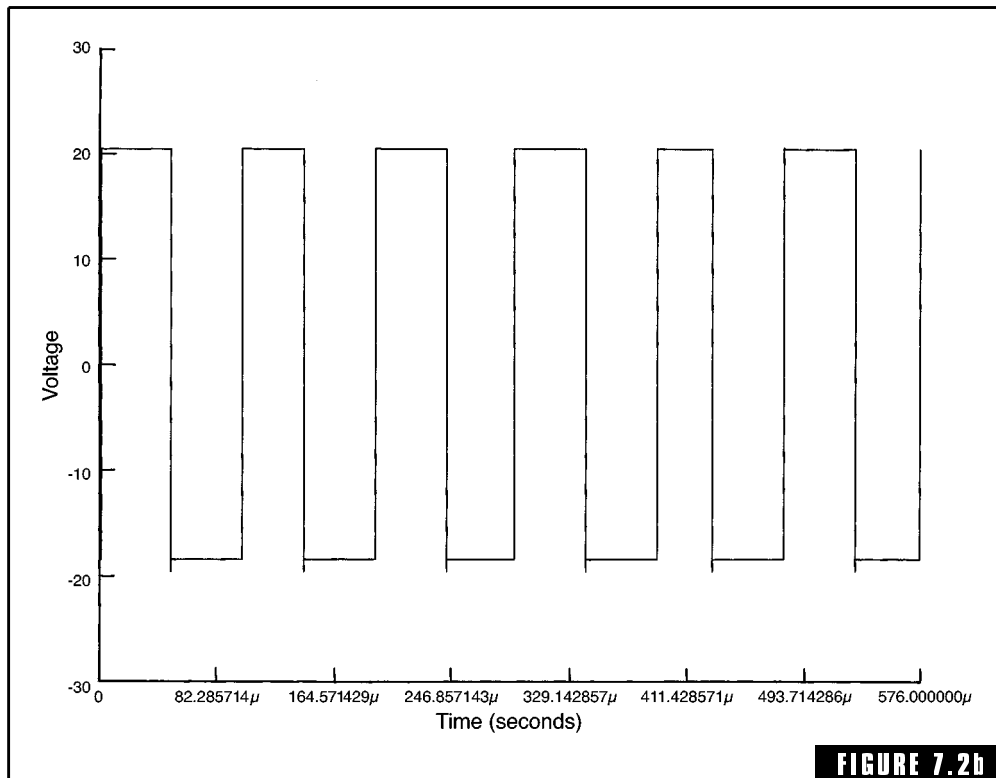

FIGURE 7.2b

Oscilloscope trace that illustrates the excellent inherent stability of the EF OPS in Figure 7.2(a).

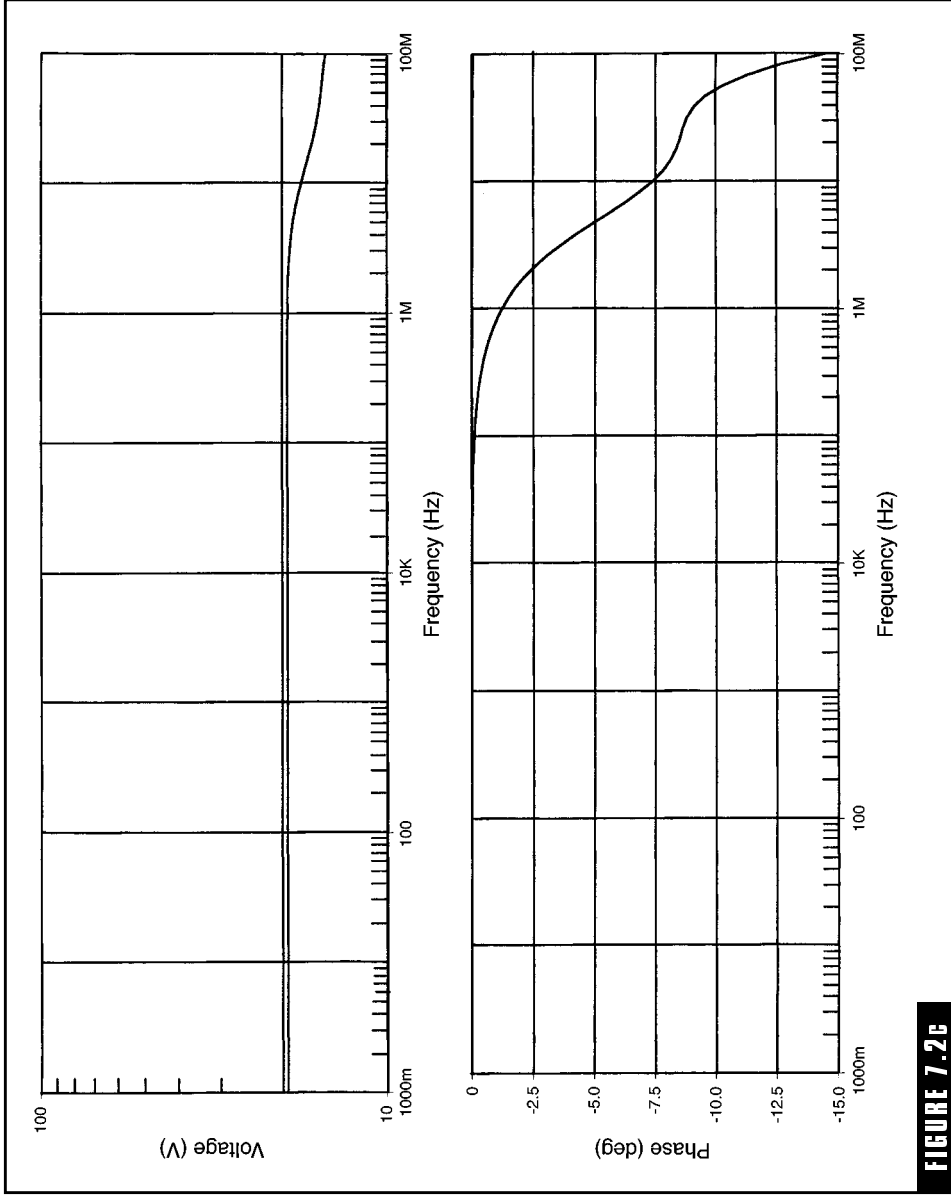

FIGURE 7.26

AC analysis of the frequency and phase response of the EF OPS in Figure 7.2(a).

improvements being made, the small high-frequency damped oscillations could be seen with an oscilloscope riding on top of the signal waveform (i.e., parasitic), tending to be more prominent at signal peaks and the crossover region. (However, the amplifier may break into self-sustaining oscillation for other reasons, as shall be discussed shortly.)

There are two internal capacitance values associated with bipolar transistors that are of concern when building audio amplifiers—the *base-to-collector capacitance* (sometimes informally called the *output capacitance*) and the *base-to-emitter capacitance*. These two capacitance values, formed by the two junctions in a bipolar transistor, are of paramount importance in building CF stages. Referring again to the oscillogram of Figure 7.3(b), the large spikes on the leading edges of the square wave are caused by a combination of the two internal transistor capacitances. The damped oscillation, however, is predominantly a result of the transistors' internal base-to-emitter capacitance combined with the voltage feedback of the CF design.

The AC analysis charts for the OPS circuit of Figure 7.3(a) reveals the reasons for the poor response to square wave stability testing. The

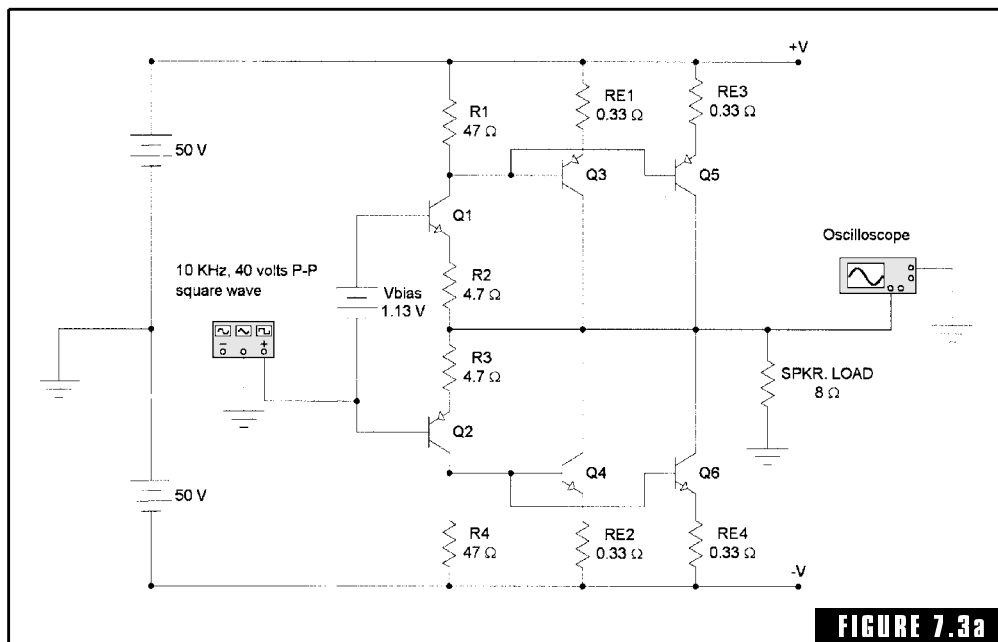

FIGURE 7.3a

Test circuit for analyzing internal CF OPS stability.

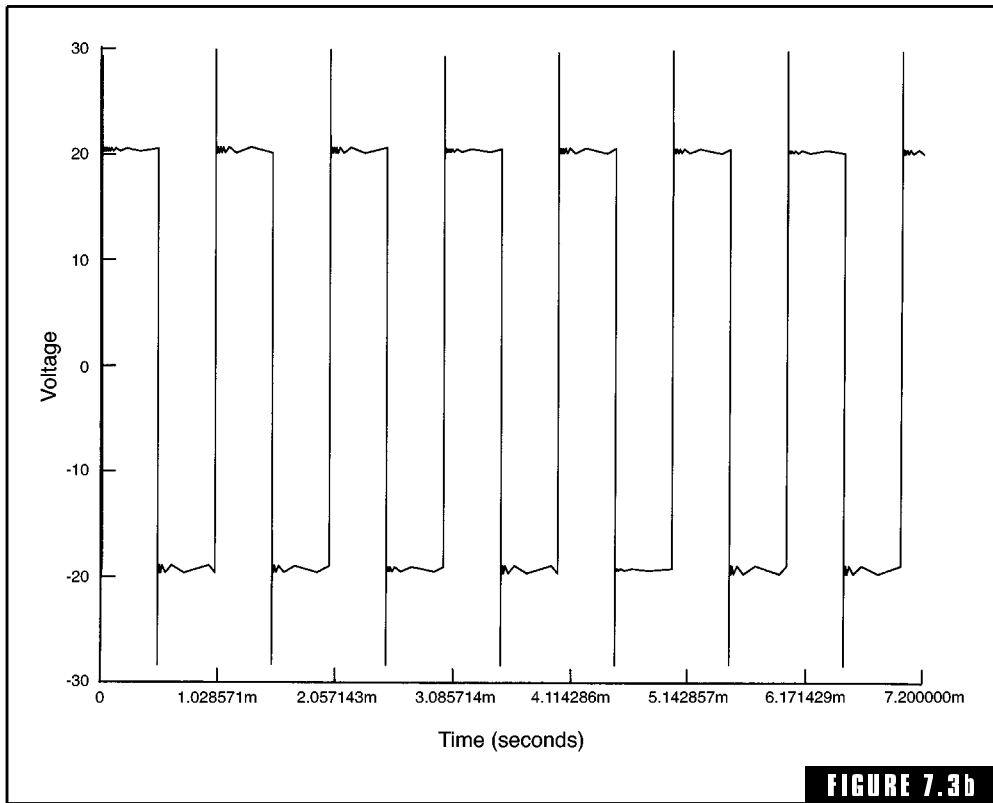

FIGURE 7.3b

Oscilloscope that illustrates the internal instability of the test circuit in Figure 7.3(a).

voltage versus frequency chart shows the voltage gain of a CF OPS to be closer to unity than an EF OPS stage (the input and output signal lines are so close they appear to be a single line). This accounts for the slightly improved efficiency of a CF OPS design. The problematic area is around 250 kHz, where there is a gain peak of the output signal. This condition should *never* exist under any circumstances within a unity-gain OPS. It indicates that positive feedback is being applied internally, suggesting that even typically reactive loads could cause catastrophic behavior, even to the point of starting self-sustaining oscillation. The cause of the voltage gain peak is the obvious two-pole phase response shown in the phase versus frequency chart. The internal phasing of the predriver and output transistor feedback loop is such that some positive feedback begins to appear through the base-emitter capacitance of

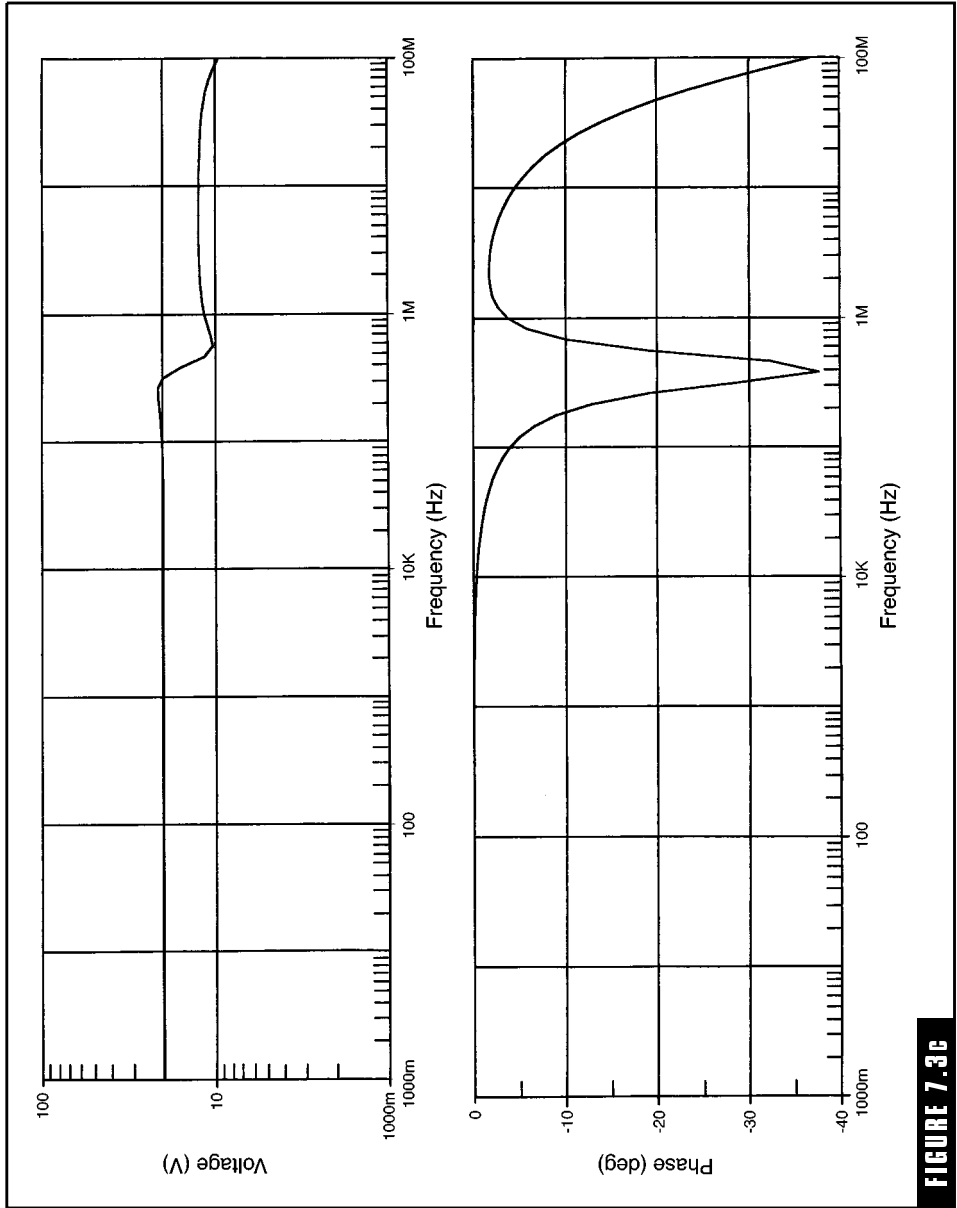

FIGURE 7.3C

AC analysis: Note the voltage gain peak indicative of destabilizing positive feedback.

the predrivers (Q1 and Q2) with only a 10-degree shift in the output signal. Such a condition could be tolerated if it occurred much higher up on the frequency spectrum, such as 10 MHz or above. However, at 250 kHz, it will most definitely cause problems.

The good news regarding this problem is that the sensitivity of a CF OPS to transistor capacitive characteristics is isolated almost exclusively to the predriver pair. If Q1 and Q2 are replaced with transistors exhibiting relatively low capacitive characteristics, the stability problem disappears. If Q1 and Q2 are replaced with a 2SB649/2SD669 pair for example, the square wave analysis will become completely devoid of any damped oscillations. It will still contain the transient spikes (reduced by about 50 percent) because they are largely a function of the internal base-collector capacitance of the output transistors. Fortunately, capacitive spiking is not generally a major concern. The AC analysis graphs will change into looking almost like the analysis graphs for the EF OPS, with the exception that the output phase angle at 100 MHz will lag by about 30 degrees (in contrast to the approximate 14-degree lag of the EF response). Happily, the voltage gain peak completely disappears.

CF OPS instability can also be remedied by installing a few external capacitors around the predriver stage (usually from the predriver collectors to the output rail). This is a poor fix, however. While improving stability, it introduces additional output phase shift and lowers the OPS bandwidth.

Figures 7.2(a) and 7.3(a) are both paralleled versions of EF and CF OPSs. The basic characteristics and responses of single-pair versions are essentially identical, and this also holds true for OPSs utilizing more than two paralleled pairs. Except in rare circumstances, the internal stability characteristics of a quasi-complementary OPS can be considered identical to an EF OPS.

External OPS Stability

The establishment of good internal OPS stability is a relatively easy undertaking, being almost assured in EF designs and a simple matter of choosing appropriate predriver transistors for most CF designs. External OPS stability is dependent upon the output loading conditions, which are not dependable in any respect other than the assurance that they will be very undependable.

Going back to the EF OPS of Figure 7.2(a), note that it was loaded with an 8-ohm resistor tied directly to the output rail. Resistive loads, commonly referred to as *dummy loads*, are universally used to test and evaluate audio power amplifiers. While it would be preferable to use real-world reactive loads, such as that presented by loudspeaker systems, it simply isn't possible. There are an infinite number of resistive and reactive combinations possible within modern speaker systems, so the best we can do is test amplifiers resistively, and build in a healthy margin of tolerance to reactive loading.

A real-world speaker system will contain a combination of inductive and capacitive characteristics. Although there is a wide variation of reactive components inherent to speaker coils, an even wider variation exists within passive crossover networks. This makes it very difficult to categorize and model speaker systems in general. If the OPS of Figure 7.2(a) were loaded with a combination of reactive components, the output rail would be subjected to the variable reactive properties of the load. This is bad news. First, the unpredictable reactance could create the generation of excessive phase shifts, spikes, or damped oscillations that could feed back into the OPS and result in OPS instability. Also, if you remember, the output rail is the takeoff point for the global NFB loop. If excessive reactive effects are present in the global NFB loop, even Nyquist stability could be compromised, which could easily be catastrophically destructive. The point is, something is needed between the output rail and the load to isolate the unpredictable effects of reactive loading. Otherwise, external OPS stability could never be attained.

Figure 7.4 illustrates two methods of radically improving external OPS stability. The first of these is called a *Zobel network*, sometimes referred to as a *Boucherot cell*. Its purpose is to counteract the effects of inductive reactance within the speaker load. For the most part, EF OPS designs seem to be rather immune to this problem, but CF designs are much more susceptible to high-frequency instability from inductive loads. In either case, the Zobel network certainly helps to clean up the output rail. Remember, a clean, stable output rail is important for both external OPS stability and global NFB stability.

Continuing to refer to Figure 7.4, the resistance value of RZ is virtually always chosen to closely equal the value of the nominal load. With rare exceptions, this means it should be about 8 ohms (10 ohms

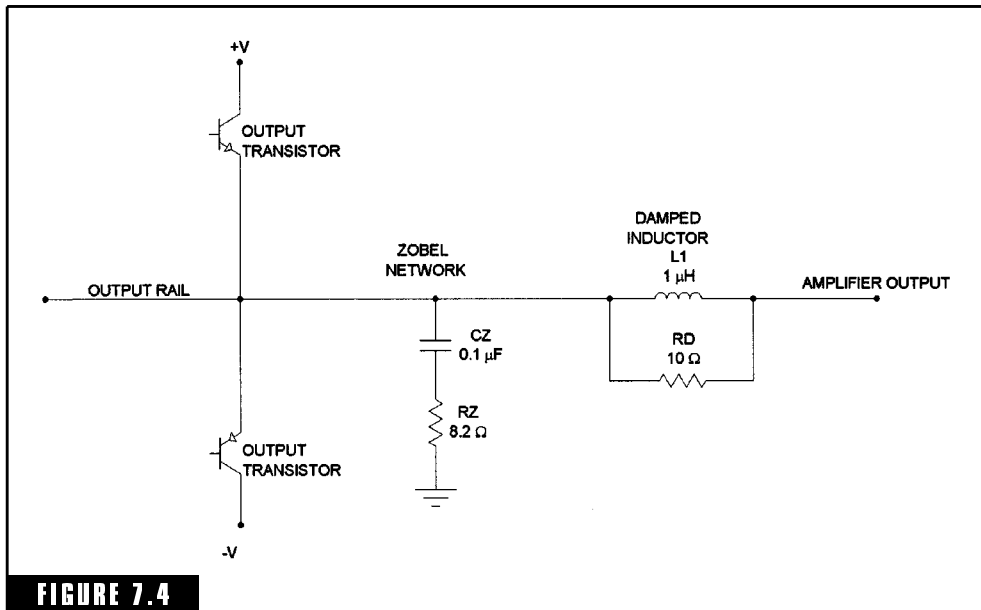

FIGURE 7.4 Output stabilization circuit illustrating Zobel network and damping resistor. Component values are typical.

works just as well, in case you have some trouble finding higher-wattage 8.2-ohm resistors). Typical values of CZ range from 0.047 μF to 0.15 μF , but 0.1 μF functions well in almost every situation, and is the more or less universally accepted value. In other words, what we have here is a circuit that works optimally for just about any size or type of power amplifier. At first thought, it might seem unusual that one circuit configuration would be optimum for a wide variety of amplifiers. However, we must remember that a Zobel network is actually a best-fit design configuration based on the output load, not the amplifier. Since nominal load characteristics are going to be considered the same for all power amplifier designs, it should not be surprising that the Zobel network changes very little from one design to another.

When incorporating a Zobel network, the only necessary calculation to make is the power dissipation of RZ. As a rough approximation, CZ will allow about 15 mA/V RMS to flow through RZ at 20 kHz (assuming CZ = 0.1 μF). Therefore, if the maximum output from the OPS is 30 volts RMS (corresponding to about 112 watts into 8 ohms), about 450 mA will flow through RZ (that is, 30 volts \times 15 mA = 450

mA). If RZ is 8.2 ohms, this calculates out to about 1.66 watts. If a power amplifier breaks into self-sustaining oscillations, the frequency of oscillations will typically be in the range of 100 to 500 kHz. Under these conditions, RZ will usually catch on fire (CZ will provide little capacitive reactance at 100 kHz or higher). As a safeguard against rapid disintegration of RZ during conditions of instability and/or high-frequency testing, many amplifier designers either double or triple the nominal power ratings of RZ.

At high frequencies, capacitive loads and/or internal capacitance of speaker cabling could cause excessive phase shifting or OPS overload conditions. The common counteractive measure against capacitive loads is the placement of a small-value choke in series with the output rail. This is illustrated in Figure 7.4. Typical values for L1 range between 1 μH to 7 μH , but I have found 1-2 μH sufficient for virtually all audio power amplifiers. L1 should always be an air core coil because the high currents flowing through it as a result of musical peaks will saturate most metallic core materials. Referring to Figure 7.4, it is a good idea to dampen L1 with a 10-ohm resistor so that ringing in conjunction with capacitive loads can be reduced to a practical minimum. As in the case of RZ, RD will also have to dissipate considerable power under adversely high frequencies. Therefore, as a rule of thumb, the power dissipation of RD can be considered to be the same value as RZ. In some cases, L1 is formed by winding turns of wire around RD. This is perfectly acceptable, but it is sometimes hard to find a resistor with the right body size needed to properly wind L1.

It should be remembered that all of the amplifier output current must flow through L1. Consequently, common sense can be used in determining the size of the coil wire depending on the output current. A 1- to 2- μH air core coil can be made by forming 16 loops of 18-AWG insulated coil wire around a 1-inch wooden dowel. This is applicable for amplifiers of 100 watts RMS or lower—wire size must be upscaled from there for greater output power capabilities. Professionally manufactured air core coils can be purchased for this application. If you happen to be very conscientious regarding amplifier aesthetics, you may want to try this option.

Figure 7.5(a) illustrates a test circuit I constructed to analyze the effectiveness of a Zobel network and output choke. For the reactive load, I purposely exchanged components until I came up with a worst-case

situation that could still be believable in terms of real-world conditions (it is worse than any speaker model that I have been exposed to, but the component values could exist within an actual speaker system). As illustrated, the dual-trace oscilloscope was monitoring the output rail and the amplifier output points of the test circuit. A 10 kHz, 20-volt P-P square wave was used as an input signal for analysis purposes. The oscillogram [Figure 7.5(b)] for Figure 7.5(a) shows how well the output stabilization circuits perform. The top waveform is the signal voltage appearing on the output rail, with the bottom waveform illustrating the amplifier output into the reactive load. In viewing the bottom waveform, the voltage spikes result from the load capacitance while the damped oscillation is a result of resonance between load capacitance and inductance.

It is surprising how well the simple Zobel network and output choke perform. As is obvious from the oscillogram, virtually all of the reactive effects of this bad-news load were effectively attenuated, leaving the output rail very clean from reactive effects. This provides



Before continuing on to the next section, there is one final comment I'd like to make regarding external

OPS stability. For many years, it has been traditional to test audio power amplifiers using an 8-ohm load paralleled with a 2- μ F capacitor. This is idealized to be the worst-case simulation of an electrostatic speaker load. Hundreds of test reports have been written equating the quality of a power amplifier with the damped ringing seen at the output. For all practical purposes, any quantitative analysis of amplifier ringing under these conditions is totally useless and proves absolutely nothing about the quality of an amplifier!! Referring to Figure 7.5(a), imagine an 8-ohm resistor paralleled with a 2- μ F capacitor as being the reactive load for the test circuit. When this circuit is tested under the aforementioned conditions, L1 and the 2- μ F load capacitor will resonate and produce ringing. The more L1 is damped (i.e., the lower the value of RD), the lower the ringing will be. The amplifier under test doesn't have anything to do with this damped response; it is a function perpetrated entirely by L1 and the reactive load. Some high-quality power amplifiers do not incorporate a damping resistor (RD) across L1. If this same test is performed without RD, the output will ring like a bell. In the practical sense, it means nothing.

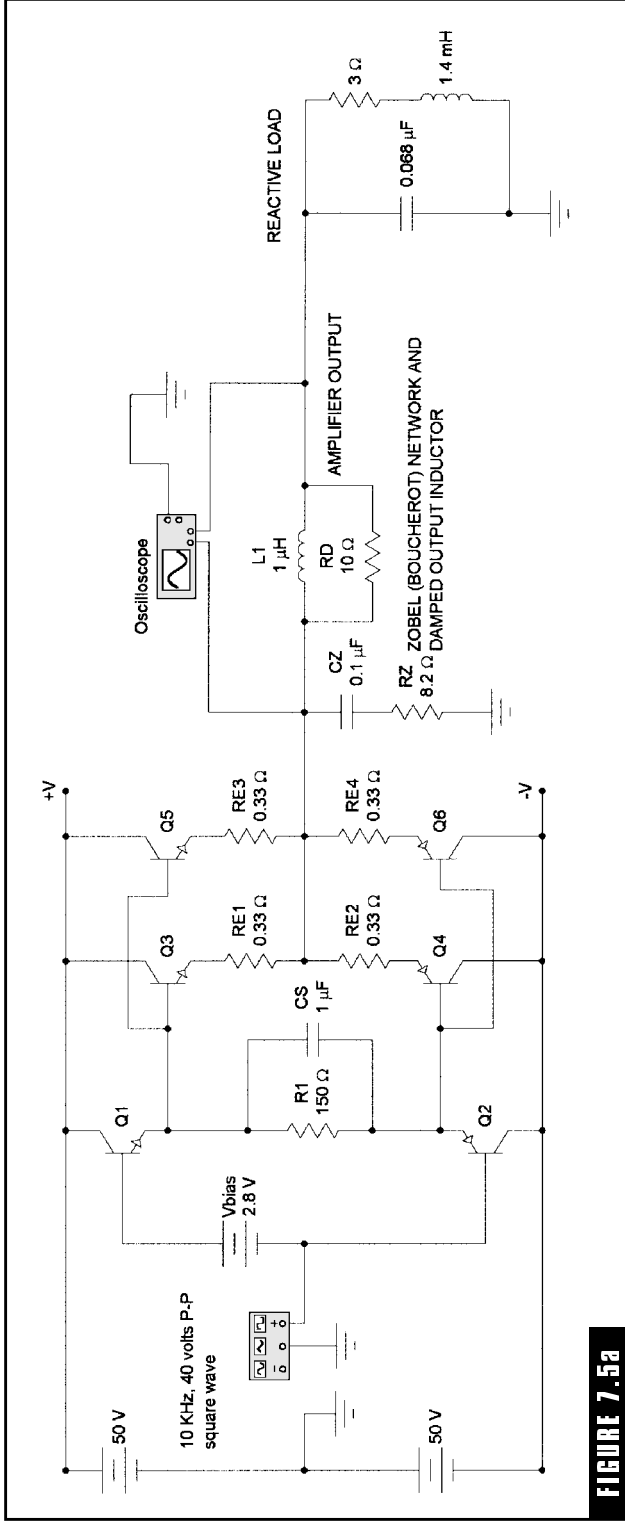
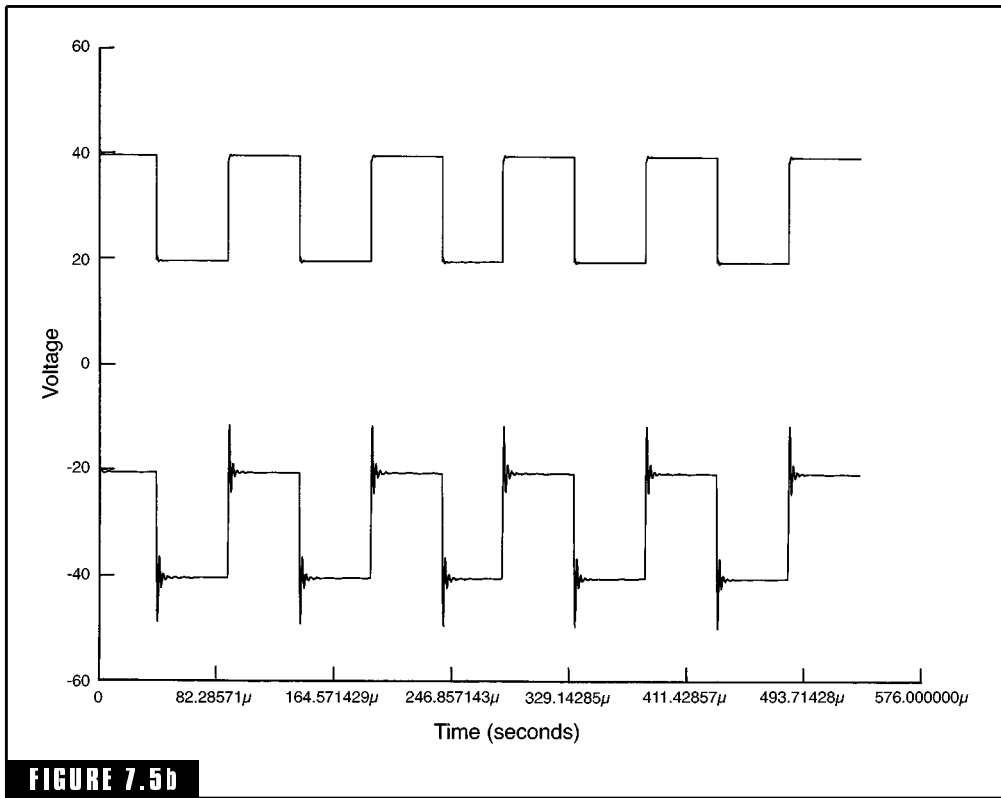

FIGURE 7.5a

Test circuit to illustrate the effectiveness of a typical Zobel network and output inductor in maintaining external stability.

**FIGURE 7.5b**

Oscilloscope that illustrates the effectiveness of a Zobel network and output inductor.

external stabilization for both the OPS and global NFB loop, while being sonically transparent and highly efficient. The component values provided in Figure 7.5(a) are applicable for virtually any audio power amplifier.

Overall Amplifier Stability

Assuming that individual stage stability is assured, there comes a time when the global NFB loop is closed and we expect the amplifier to perform like a champ! Unfortunately, in some cases, the amplifier will quickly pass from the oscillator phase to the destruction phase to the smoking phase to the dead-champ phase. This adverse reaction is not because we happened to be unlucky! It is due to a lack of understand-

ing regarding the fundamentals of amplifier stability and the negligence of following through with a systematic approach to assuring it.

The consideration of compensation is a good place to start when evaluating amplifier stability characteristics. *Compensation* is a method of tailoring an amplifier's open-loop gain and phase characteristics so that it remains stable in a closed-loop environment. As internal amplifier frequencies become higher, there is an increasingly wide lagging phase shift between the amplifier's input and output terminals. The function of the dominant-pole capacitor (CC) is to ensure that the voltage gain factor of the amplifier drops below unity before a phase shift close to 180 degrees can occur. The accomplishment of this characteristic is called *Nyquist stability*. When the voltage gain drops below unity, self-sustaining oscillation resulting from output phase shift conditions cannot occur.

Referring to the amplifier schematic of Figure 7.6(a), let us examine a few operational details. In Chapter 5, it was explained how the value of CC (i.e., the compensation capacitor) could be arrived at. In the Figure 7.6(a) design, a good value for CC would be about 150 pF. (The CC_{IPK} for Figure 7.6(a) comes out to about 2 mA based on a CC value of 150 pF. Following the calculation procedure detailed in Chapter 5, the calculated value for individual tail currents should be about 4.8 mA. Therefore, a standard value of 120 ohms can be used for R10 and R11.) Since Figure 7.6(a) is a mirror-image topology, the value of CC can be split between the two complementary VA stages, making C8 and C11 come out to 75 pF each. Two-pole compensation is being utilized in this design, and the values of C9 and C12 were obtained by the rule-of-thumb method of simply multiplying the value of the compensation capacitors by a factor of 5 to 10. I already had an excess stock of 500-pF capacitors so I decided to use them for no other reason, but standard values of 470 pF and 560 pF will function equally well.

Throughout this book I have concentrated on dominant-pole compensation, meaning the use of a compensation capacitor (CC) to swamp any higher-frequency poles and force the amplifier's frequency bandwidth characteristics to be dominated by the compensation capacitor. For example, capacitor C8 in Figure 7.8(a) is much higher in capacity value than the combined base-collector capacitance of Q9 and Q10. Therefore, since all voltage amplification occurs in the VA stage, C8 will play the dominant role in establishing the frequency bandwidth of the amplifier.

In contrast to dominant-pole compensation, there are other compensation methods that have been used throughout audio history. One method, called *lag compensation* (sometimes referred to as *shunt compensation*), is the technique of connecting the compensation capacitor from the output of the VA stage to signal ground. Unfortunately, lag compensation promotes VA distortion by loading the VA transistor, the placement of CC does not provide for any linearizing local NFB, and the required capacity increase of CC places additional burdens on external circuitry to supply the necessary charge-discharge currents for adequate slew rates. In other words, lag compensation is suboptimal from every perspective.

Inclusive compensation, as the name implies, is the inclusion of the OPS in the compensation loop. In other words, instead of CC connecting from the output to the input of the VA stage, it would connect from the output of the OPS to the input of the VA stage. The motivation behind this method is to allow the OPS to take advantage of the high-frequency (i.e., above P1) linearizing loop of the VA stage, but the addition of the OPS into the compensation loop deteriorates Nyquist stability to an almost nonfunctional level. (Nested-feedback techniques are a much better approach to afford the same type of linearizing benefits.)

Consequently, this is one of those cases where a singular method seems to be the only viable approach. So for the time being, it appears most prudent to simply stick with dominant-pole compensation and its variants.

With simple dominant-pole compensation, there is a constant 90-degree phase lag between the VA input signal and the VA output voltage with all frequencies above the P1 point. The 90-degree phase shift corresponds to the 6-dB/octave gain rolloff above the P1 frequency, and is commonly referred to as the *phase margin*. Two-pole compensation, as utilized in the amplifier of Figure 7.6(a), adds a secondary pole of higher frequency than P1, effectively delaying open-loop gain rolloff until a higher frequency. The phase margin inherent to two-pole compensation is much wider at certain frequencies, becoming about 120 degrees at the knee point of the extended open-loop gain rolloff point. This is still a very stable condition, however, because the knee point is set to occur at relatively low frequencies compared to the much higher frequencies (i.e., above 100 kHz) where the greatest sensitivity to instability problems exists.

If you observed the phase relationship between the input signal and output signal of the power amplifier illustrated in Figure 7.6(a), you would discover that the input and output signals are in phase, even above the P1 frequency. So what happened to the 90-degree phase margin of the VA stage? In reality, the input stage is functioning in quadrature above the P1 frequency, meaning that it is producing four separate outputs, each of which is 90 degrees out of phase with the others. Below the P1 frequency, a differential input stage simply amplifies the error signal produced from the summation of the input signal and the in-phase NFB signal. However, above the P1 frequency, the NFB signal begins to lag by 90 degrees as a result of the phase margin of the VA stage. This causes the summed error signal at the differential input stage to have an even greater phase differential, which is amplified and applied to the input of the VA stage. The error signal drive to the VA stage forces the output signal back into an in-phase condition with the input signal. Therefore, the phase margin of the VA stage exists, but it is not externally visible until the closed-loop response reaches its high-frequency rolloff point (i.e., the point at which the global NFB loop loses control of the gain response).

Since compensation involves tailoring the open-loop voltage gain, it seems rather obvious to point out that open-loop gain is interactive with compensation from a stability perspective. As an aid to understanding this relationship, imagine a hypothetical power amplifier with some amount of open-loop gain, utilizing simple dominant-pole compensation and providing very stable operation. Suppose the open-loop gain of this amplifier is increased by +30 dB without changing any other parameter. Since the P1 frequency hasn't been changed and capacitor CC is always going to cause the open-loop gain to rolloff at 6 dB per octave, the high-frequency point at which the open-loop gain drops to unity has now been extended by 5 octaves (that is, +30 dB divided by 6 dB per octave=5 octaves). It is highly doubtful that this hypothetical amplifier will continue to be stable under these final conditions.

Open-loop gain, although bandied around by a lot of audiophiles, is actually rather unimportant. To quote the first commandment of design engineering, "Whatever cannot be controlled should be made irrelevant." Basically, this is what we have accomplished in high-performance audio power amplifiers. Open-loop voltage gain is calculated by multiplying the input stage transconductance by the VA stage transimped-

ance, which places it in the arena of ambiguity due to its dependence upon ill-defined variables such as transistor beta and rather wide component tolerances. However, we can be certain that open-loop voltage gain will be very high, and that is all that is really important. We also need to remember that VA voltage gain will begin decreasing by a 6-dB/octave rate above the P1 frequency, but the transconductance of the input stage will remain constant. Therefore, compensation factors can be approximated based on input stage conditions (i.e., conditions dominating CC's charge-discharge rate) and OPS voltage swing, with overall stability emerging as an automatic consequence. This approach assumes the VA stage gain is high at low frequencies, which will always be the case in high-performance topologies.

The closed-loop voltage gain of an audio power amplifier is arrived at through a series of related considerations. First, the desired input impedance for the amplifier must be decided upon. For the amplifier of Figure 7.6(a), the input impedance is dominated by the value of R9 (the input impedance to the differential amplifier stages is so high it can be considered infinite for calculation purposes). Since R9 was chosen to be 10 k Ω , R15 must also be 10 k Ω so that the amplifier's balance and low DC offsets can be maintained. The closed-loop voltage gain of Figure 7.6(a) is determined by the ratio of R15 and R12. It must be calculated on the basis of application—the higher the output power, the higher the closed-loop voltage gain must be. For example, for the amplifier of Figure 7.6(a) to output 120 watts RMS into an 8-ohm load, it must be capable of outputting about 31 volts RMS across the load. If the desired amplifier input sensitivity is about 1 volt RMS, then the closed-loop voltage gain must be about 31. The closed-loop gain for the amplifier of Figure 7.6(a) is calculated from the following equation:

$$A_{E(CL)} = \frac{R15+R12}{R12} = 31.3$$

Naturally, the actual voltage gain of 31.3 is close enough to the desired voltage gain of 31 for all practical purposes.

The entire global NFB loop incorporated in the amplifier of Figure 7.6(a) consists of R15, R16, C10, R12, C6, and D3. C10 establishes a DC negative-feedback factor of 100 percent, since its impedance is infinite relative to DC levels. This technique provides excellent DC stability and low DC offsets. As stated previously, D3 conducts any reverse-polarity

voltages that could be applied across C6 in the event of an OPS failure. R16 and C10 form a feed-forward network. C10 acts as a speed-up (i.e., phase advance) capacitor to help correct for greater phase lags inherent to higher frequencies. This provides a minor stabilizing effect and also adds a slight improvement in distortion performance. As stated earlier, R12 and R15 establish the closed-loop voltage gain. Too much global NFB applied to an audio amplifier will cause severe instabilities, even resulting in self-sustaining oscillation; global NFB and compensation must work together for good Nyquist stability. For example, if we reduce compensation too much, high frequencies that have been phase-shifted in excess of 180 degrees will be applied to the input stage, causing regenerative feedback and oscillation. Likewise, when we apply too much global NFB, we are actually decreasing the attenuation of high-frequency phase-shifted signals to the input stage. The same type of instability results.

The stability performance of the amplifier in Figure 7.6(a) can be analyzed by observing its associated AC analysis charts. The upper chart, representing the voltage-versus-frequency analysis, represents almost ideal characteristics for a high-performance amplifier. The flat horizontal line represents the input signal voltage, which was set to 0.9 volts RMS. The speaker output signal, represented by the response line above the signal voltage, maintains a flat response throughout the entire audio bandwidth at about 30 volts RMS (indicating the closed-loop gain to be approximately 31). Note that the output voltage drops to around 15 volts at 2 Hz caused by the low-frequency response of the input coupling capacitors C1 and C2. The closed-loop gain response begins to roll off at about 300 kHz, falling below unity gain at about 4.5 MHz.

The lower AC analysis chart shows the amplifier output phase response relative to the input signal. The flat line at 0 degrees represents the input signal. The leading phase angle curve from about 1 to 20 Hz is caused by the combined reactance of C6 and the input coupling capacitors C1 and C2.

The amplifier's input and output signals remain in phase throughout the audio bandwidth, but at around 40 kHz, a noticeable output phase lag begins to develop. (*Note:* This is the frequency point at which the closed-loop response and open-loop response begin to meet each other, causing the emergence of the phase differential.) The evidence of two-pole compensation cannot be seen in a closed-loop

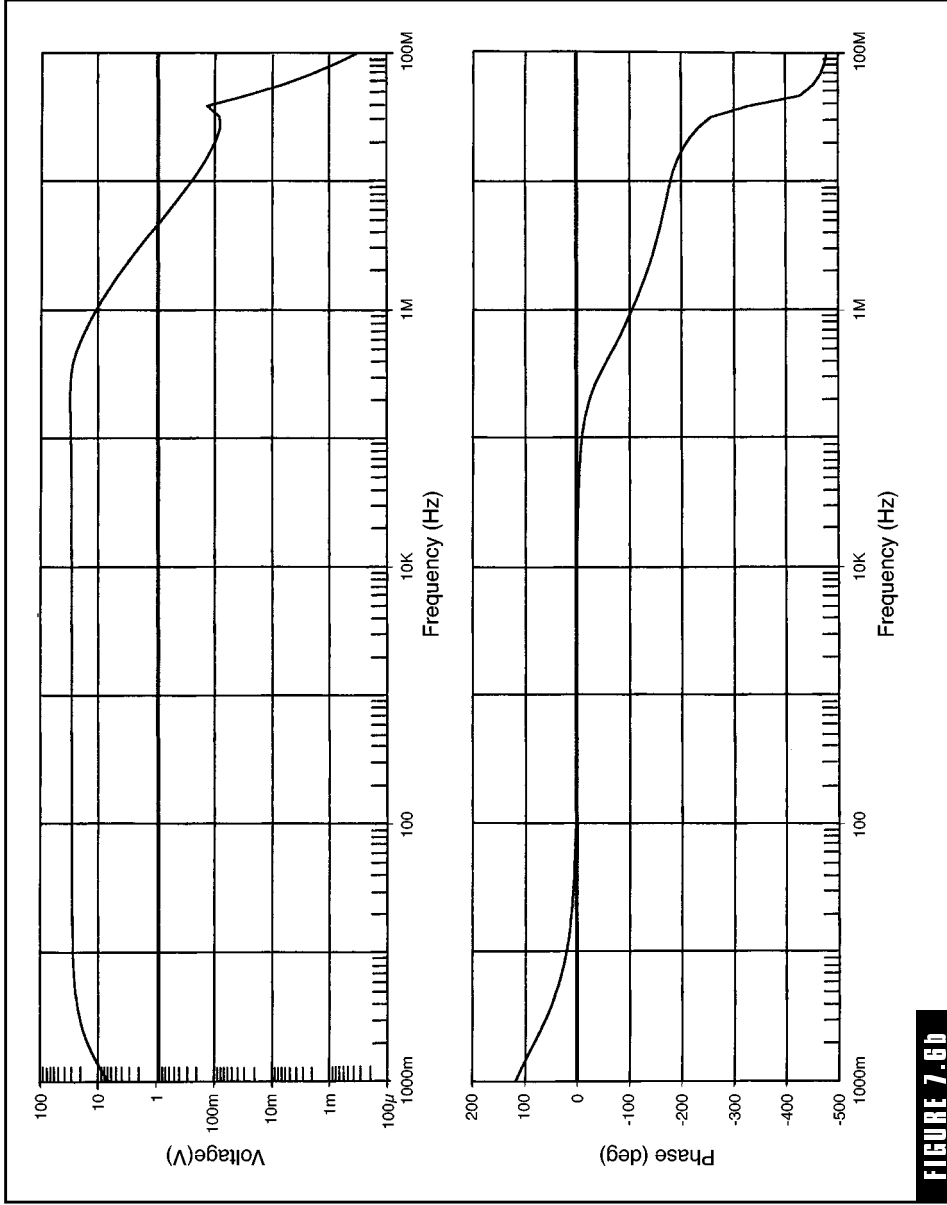

FIGURE 7.6b

AC analysis of the frequency and phase response of the amplifier design in Figure 7.6(a).

analysis since its only function is to extend the open-loop bandwidth beyond the P1 point for increased global NFB benefits.

The AC analysis graphs of Figure 7.6(a) also demonstrate how compensation and global NFB should work together for good Nyquist stability. Note that compensation forces the rolloff of high frequencies before they can cause the output signal to reach a 180-degree phase lag, *while the correct amount of global NFB works with compensation to attenuate higher frequencies well below the unity gain level*. The output signal drops below unity gain at about 4.5 MHz, corresponding to an output signal lagging phase shift of approximately 150 degrees.

The first signs of amplifier instability will usually appear as an increase in closed-loop gain at a specific frequency. For example, in the analysis charts of Figure 7.6(b), if the upper gain-versus-frequency graph showed a gain peak at some frequency point, it would indicate the injection of positive feedback from some undesired source. When testing audio power amplifiers with a signal generator, it is always a good habit to run through the entire bandwidth of the amplifier while observing the output amplitude. If you see any peaking of output gain during this process, you are right on the hairy edge of self-sustaining oscillation.

Just for the sake of discussion, I connected the reactive load of Figure 7.5(a) to the output of the amplifier illustrated in Figure 7-6(a). The amplifier did not show any signs of instability, but there was excessive ringing on the output signal. This was due to the fact that L1 was not damped. Personally, I have not seen any great need to dampen the output inductors of most power amplifiers. The damped oscillations are not going to appear on the output rail, and the frequencies involved are too high to worry about. The exception to this rule may be situations in which an amplifier is being tested by an outside party for evaluation purposes, in which case you would obviously want the waveform analysis to look as good as possible on an oscilloscope. Regardless of the controversy over this issue, I placed a 10-ohm, 5-watt resistor across L1 and all of the ringing virtually disappeared. In fact, with the damping resistor in place, the waveform analysis looked exceptionally good, and I must admit to being mildly surprised at this.

A General Summary of Stability Concerns

Although some of the points brought forth in the previous discussions may be quite thought provoking, the general methods of assuring good

stability are not complicated. The following is a type of checklist that could be helpful in placing all of the theory and technical details into a practical perspective.

Temperature Compensation Stability: Incorporate a good amplified diode bias generator with at least 10 μF of capacitor filtering. Mount Q_{bias} to the transistor casing that is to be temperature monitored, if possible (for the reduction of thermal delays). If point-to-point wiring must be used to connect Q_{bias} to the PC board, make the wiring as short as possible, and do not run it close to any high-current PC board tracks or significant EMI sources. Precise V_{bias} adjustment should be made with the OPS heatsink at its maximum running temperature.

Output Stage Stability: In EF designs, use a switchoff network for the reduction of switching distortion. If possible, mount the predriver transistors to the same heatsink as the output transistors for optimum thermal tracking. In CF designs, use low-capacitance predriver transistors, and keep the resistance values of the resistors used in the predriver circuits as low as practical. It is best *not* to mount the predriver transistors to the same heatsink as the output transistors.

Overall Stability: Establish a reasonable value for CC utilizing the guidelines provided in Chapter 5. This step requires a predetermination of anticipated power output levels and input stage tail currents. If possible, use a beta-enhancement technique in the VA topology to provide adequate gain characteristics. Calculate the desired amplifier input impedance, establishing the resistance value of one of the closed-loop gain ratio resistors [that is, R15 in Figure 7.6(a)]. The remaining ratio resistor [that is, R12 in Figure 7.6(a)] can then be calculated according to the required closed-loop gain. Use a DC blocking feedback capacitor [that is, C6 in Figure 7.6(a)] in the global NFB loop to provide 100 percent DC voltage feedback. DC offset reduction and DC stability are both improved by this modification.

If the previous overall stability guidelines are followed sequentially, the correct relationships between open-loop gain, closed-loop gain, global NFB factor, and compensation should automatically be accomplished to a functional degree. Naturally, depending on the type of semiconductors utilized and the applications involved, the exact performance

of the amplifier can then be tweaked with minor component variations until optimum performance is achieved.

Distortion Mechanisms

In many respects, this section will be redundant to earlier discussions involving the origin and analysis of distortion mechanisms. However, since distortion is such an overwhelming concern of sonic quality, I felt it was necessary to consolidate the major principles of distortion into one convenient section. In addition, this section will go a little deeper into the physics and theory involved in distortion generation, some of which has never been published to the best of my knowledge.

Crossover Distortion

Virtually all audio design personnel agree that crossover distortion is the most tenacious of all distortion mechanisms, being the only type of distortion that cannot be rendered benign or effectively shoved below the noise floor. The very existence of class A advocates is a formal protest against crossover distortion, with most audio enthusiasts sadly resigning themselves to living with it. Although it is true that crossover distortion cannot be completely eliminated (at least, at our current technological level), it is also true that crossover distortion is not as impossible as it is reputed to be. If the proper design methodology is followed to take advantage of all of the crossover linearization techniques, crossover distortion can fall well below the THD performance of some of the most elite class A amplifiers. This makes me wonder how many audiophiles have rejected class B amplifiers due to what they believe is audible crossover distortion when, in fact, they were hearing an entirely different kind of distortion altogether. Not all class B amplifiers are good class B amplifiers!

As explained in several previous discussions, crossover distortion is created from the nonconjugate exponential V_{be}/I_c curves (or V_{GS}/I_D curves) of the output devices while they are entering the cutoff (or pinchoff) region. Crossover distortion occurs in the zero-crossing area of the output waveshape, thereby making all signal types and amplitudes susceptible to its influence. V_{bias} can go a long way in reducing the detrimental effects of crossover distortion, but the low-current exponential curves of the output devices cannot sum into the creation of a linear transfer characteristic, regardless of the setting of V_{bias} .

It has been taught that crossover distortion is a constant, exerting the same absolute distortion regardless of the output amplitude. This would tend to make one believe that if crossover distortion measured 0.01 percent at 100 watts RMS, it would become 0.1 percent at 10 watts RMS, and an intolerable 1 percent at 1 watt RMS. Fortunately, this isn't even remotely close to the truth; crossover distortion decreases as the output amplitude decreases. The following discussion explains the reason for this unexpected behavior. Figure 7.7(a) illustrates a test circuit used to analyze the characteristics of crossover distortion at different output amplitudes. Notice the OPS is severely underbiased ($V_{\text{bias}}=0$ volts) so that the principles involved will show up easily on an oscilloscope. Initially, V1 is adjusted to 1 volt RMS, and the output waveform is illustrated in the Figure 7.7(c) oscillogram. The crossover distortion at this output level takes on the appearance of a horizontal step in the middle of the waveshape. This indicates that the greatest amount of energy directed toward the generation of nonfundamental harmonics will be focused in the lower-frequency realms (i.e., a horizontal line denotes DC in contrast to a vertical line denoting infinite frequency). The associated Figure 7.7(b) Fourier analysis graph confirms this supposition, showing all the higher-level crossover artifacts to be in the lower-freqs.

If the signal generator (V1) of Figure 7.7(a) is increased to 4 volts RMS, the oscillogram in Figure 7.7(e) results. Note that the horizontal steps of the 1-volt oscillogram have changed to slope lines, appearing to be at approximate 45-degree angles. This indicates that the energy directed toward harmonic generation is now directed to frequencies higher than in the previous analysis. The Fourier analysis chart in Figure 7.7(d) confirms this fact, illustrating that the harmonic generation is more evenly dispersed throughout the entire audio spectrum.

The important principle involved in these two tests is that *the frequency of crossover artifacts increases with an associated increase in output amplitude*. Note that this principle has nothing to do with the level of crossover distortion—only the frequency components associated with it. In going back to the principles involved with global NFB, it was established that global NFB is much more effective at eliminating distortion in the lower-frequency realms. Consequently, as the amplitude of the output signal decreases, the frequency content of

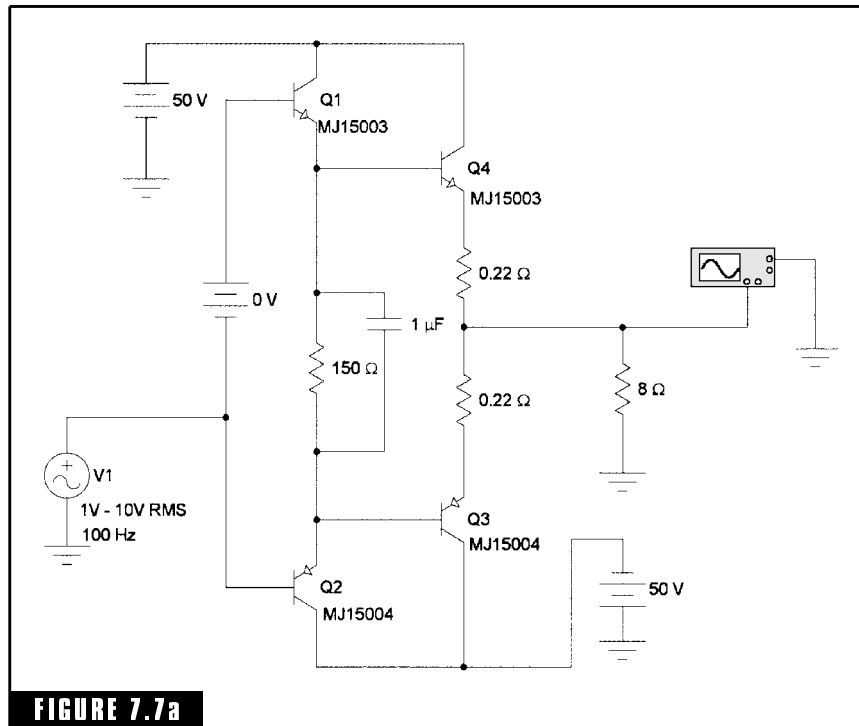
**FIGURE 7.7a**

Test circuit used to demonstrate how crossover distortion decreases with amplitude.

crossover distortion is pushed down into the lower-frequency regions where it can be effectively eliminated by the global NFB.

The reduction of crossover distortion in proportion to output amplitude reduction is not a linear function. Depending on the type of OPS design and the setting of V_{bias} , crossover distortion will decrease with output level, but at a comparatively reduced rate. The bottom line is that the percentage of crossover distortion at the lowest listening levels may be about three times higher than its percentage at maximum output. For example, if a hypothetical amplifier produces 0.003 percent of crossover distortion at 100 watts RMS, the percentage of crossover distortion could increase up to 0.009 percent at 1-watt output levels or lower.

EF OPS designs provide better performance in this area, with crossover artifacts becoming almost nonexistent at power output levels below 1 watt. In contrast, CF OPSs have a much narrower crossover region, forcing a larger portion of the crossover energy to be directed

toward the production of higher-frequency harmonics. In either case, optimum biasing and adequate global NFB techniques will bring crossover distortion artifacts down to levels far below human perception at low amplifier output levels.

It should be noted that the crossover distortion tests performed with the circuit of Figure 7.7(a) were all done within the crossover region. If you recall, the crossover region of an EF OPS is about 7 volts (dual-polarity) from the zero crossing point. This is descriptive of the entire nonlinear crossover region, much of which does not look as bad as the portion closest to the zero crossing point. Consequently, the 1-volt and the 4-volt tests utilized waveforms entirely enveloped in the crossover region. This explains the dramatic increase in THD when the output was increased from 1 to 4 volts. The accuracy of the principle involved is not compromised by this condition, as Fourier

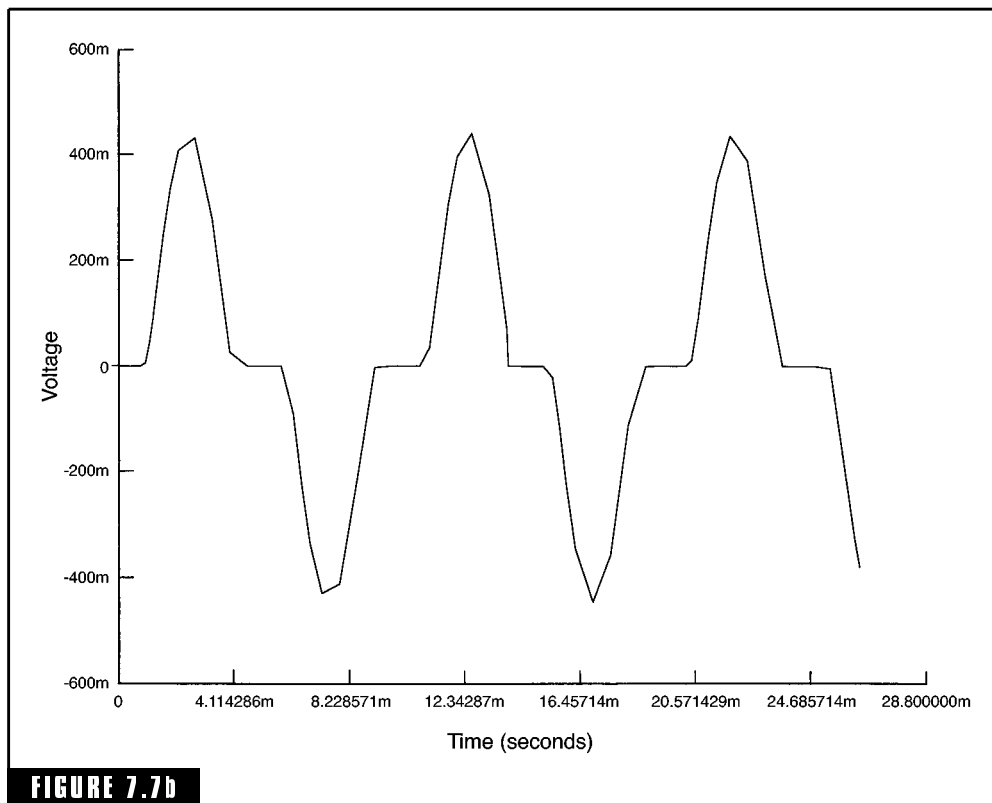

FIGURE 7.7b Oscilloscope of the low-level output of the test circuit of Figure 7.7(a).

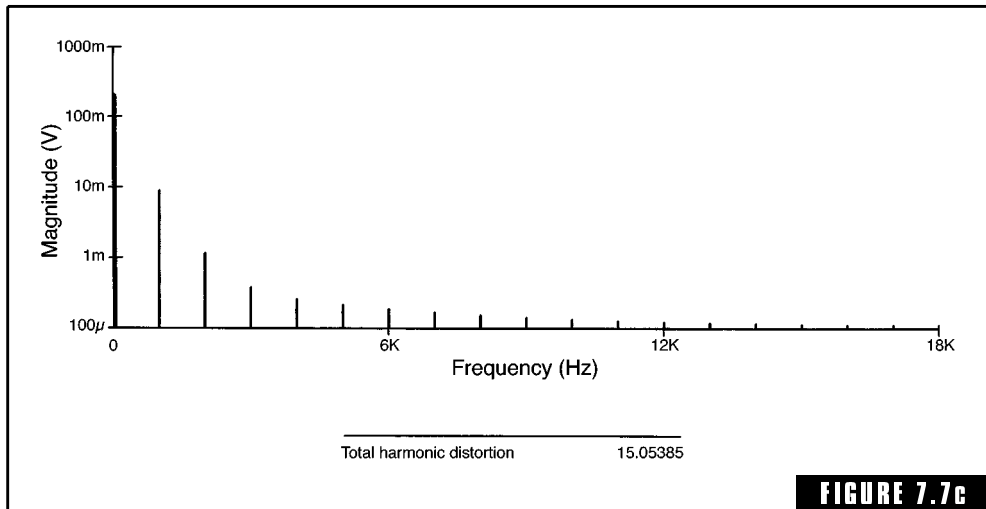

FIGURE 7.7c
 Fourier analysis of the low-level output of the test circuit of Figure 7.7(a). Note that the harmonic content of the crossover distortion is primarily in the low-frequency region.

analysis at higher output levels clearly indicates. I chose to use lower-level outputs for demonstration purposes because the principle is easier to see on an oscilloscope.

Audio hobbyists are often confused regarding the best method for adjusting the bias generator to obtain the optimum V_{bias} and lowest crossover distortion. Unfortunately, the best method requires the use of a good distortion analyzer, which is not always available to the typical hobbyist. There are other less accurate methods that usually provide satisfactory results.

Note: More information regarding V_{bias} adjustment will be provided in Chapter 13.

Large-Signal Nonlinearity (Beta-Droop) Distortion

All bipolar transistors exhibit the characteristic of decreasing beta parameters at higher collector currents. In OPS operation, this can cause a type of large-signal nonlinearity commonly referred to as *beta droop*. Simply stated, it means the current gain factors in a bipolar transistor OPS will drop off at peak current outputs—hence the name “beta droop.” MOSFETs are mercifully immune to this shortcoming

due to their different operational principles, albeit they have enough problems in contrasting areas.

Beta droop is the fundamental problem behind the effect of increasing distortion at higher power outputs, especially in cases where the amplifier is applied to driving 4-ohm loads instead of 8-ohm loads. This is one of several reasons that I advocate the complete abandonment of 2-ohm speaker loads (perhaps with the exception of automotive stereo). It is difficult enough to maintain good linearity with 8- and 4-ohm loads, especially in light of the radically variant reactive characteristics of loudspeakers and crossover networks. Doubling the already shaky current problems of 4-ohm loads by descending further downward into the 2-ohm realm seems to be a borderline exercise in audio psychosis.

It is interesting to note that the most severe aspect of the beta-droop problem lies with the predriver transistors rather than the output transistors. At first thought, this seems somewhat contradictory, since the output transistors are going to see the greatest I_c variations. However, it should be remembered that the gain factors of the predriver transistors will be effectively multiplied by the gain factors of the output drivers. Since the predriver transistors are typically lower-dissipation

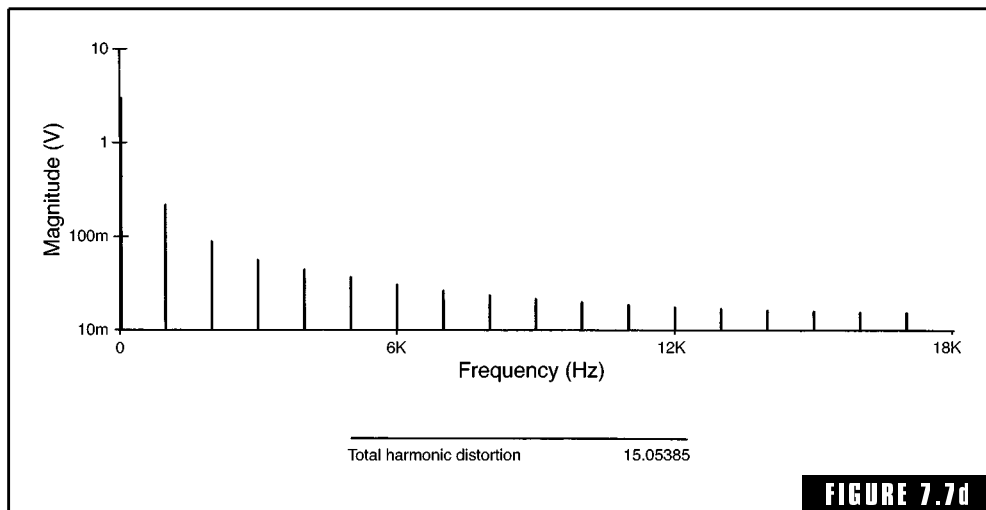

FIGURE 7.7d
Fourier analysis of the higher-level output of the test circuit in Figure 7.7(a). Note how the harmonic content of crossover distortion has dramatically increased in high-frequency content.

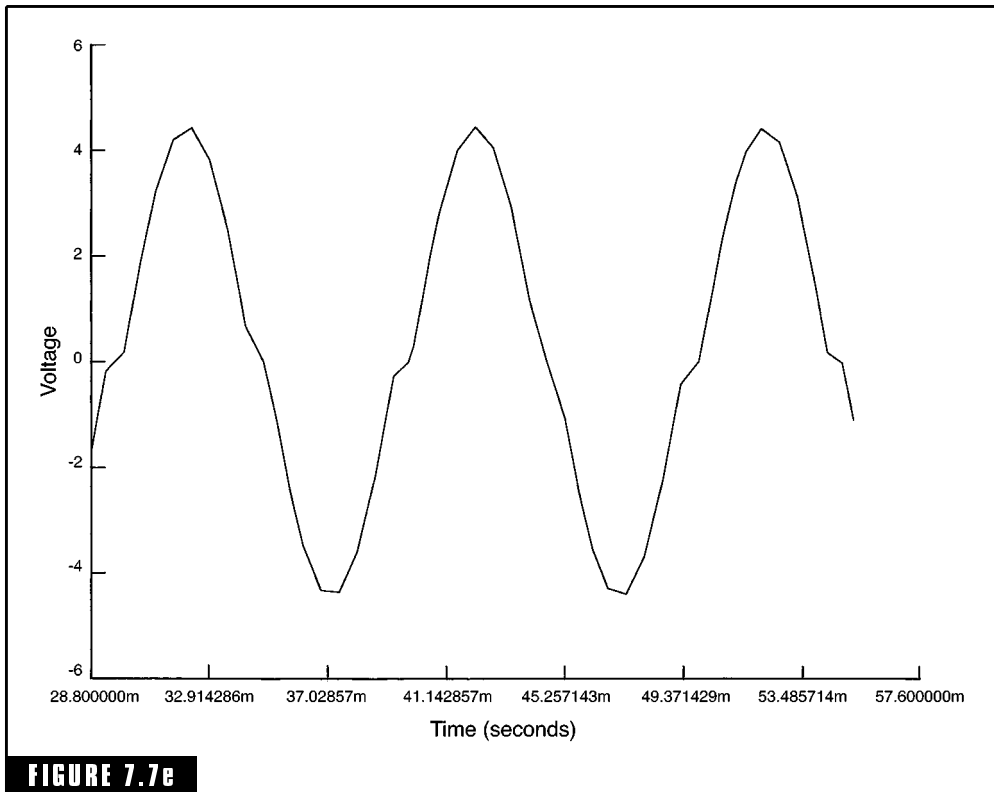

FIGURE 7.7e Oscilloscope of higher-level output from the test circuit in Figure 7.7(a).

devices with higher beta values, they are prone to wider beta variances as a product of I_c changes. Spice simulation indicates that if the beta is held as a constant in the predriver transistors, beta-droop problems are effectively eliminated.

An accurate understanding of the beta-droop problem clarifies several methods of reducing and/or effectively eliminating it. CF OPSs are automatically more immune to beta droop due to their inherent local NFB loop. If the load demands placed on the predriver pairs are kept to a minimum, beta droop can barely be detected when driving 4-ohm loads. Beta-enhancement techniques (i.e., Darlington pairs) incorporated into the predriver stage are an obvious solution applicable to both EF and CF OPSs, but they also add an additional stage of phase lag which could lead to instability problems. Again, if applying this technique, it becomes a matter of paramount importance to utilize

predriver transistors with low inherent capacitance parameters. Along this same line of reasoning, it is not surprising that OPS triples are very good in respect to large-signal linearity.

Unfortunately, this is one of those compromise situations wherein the best interests of beta-droop reduction conflict with the best interests of switching distortion reduction. As explained previously, switching distortion problems are improved by lowering the resistance values associated with the predriver stage. This provides low-impedance discharge paths for any stored transistor charges in the output transistors. In contrast, lowering the associated predriver resistance values increases the I_c maximums seen in the predriver stage, proportionally increasing beta-droop effects.

With all things considered, the following steps appear to be the most realistic at keeping beta-droop problems to a minimum. In EF OPS designs, utilize a switchoff network, and keep predriver loading to a minimum. The use of well-chosen predriver transistors is crucial. It is desirable to have high beta, voltage, and frequency parameters for this application; I have found the 2SB649/2SD669 complementary pairs hard to beat in this respect. The good inherent stability characteristics of EF OPSs make them a better candidate for beta-enhancement techniques.

With the exception of incorporating beta-enhancement techniques, the same basic guidelines apply to CF OPS designs. The improved linearity characteristics of CF stages allow a little more flexibility regarding predriver loading concerns. This is fortunate because there isn't any easy way to minimize switching distortion in CF stages other than lowering the predriver stage impedance.

Unfortunately, it becomes difficult to effectively reduce beta-droop problems in QC OPS designs. The combination of EF and CF techniques in a singular OPS has an opposing incompatibility in this respect. The most that can be hoped for is low large-signal nonlinearity resulting from using the most appropriate predriver transistors.

Switching Distortion

Switching distortion has already been discussed rather extensively in the previous chapter, but the following brief reiteration is provided in keeping with the general theme of this section. Switching distortion occurs in complementary output transistors resulting from

their inability to switch off (i.e., go into cutoff) fast enough when the output signal is passing through the zero crossing point. At higher audio frequencies, this switchoff delay can manifest itself in the form of *cross-conduction* (i.e., both output transistors conducting at the same time) causing a type of distortion very similar to *gm* doubling. For this reason, switching distortion is often mistaken for crossover distortion. The difference, however, can readily be detected since switching distortion will usually disappear at lower frequencies. In extreme cases, switching distortion can cause rapid overheating of the output transistors and/or destruction of the same.

In the case of EF OPS designs, switching distortion can be virtually eliminated by using an appropriate switchoff network as detailed in Chapter 6. With CF OPS designs, the absolute elimination of switching distortion would require two additional power supply rails of slightly higher voltage. While this is almost certainly impractical for the benefits derived, switching distortion can be reduced to very acceptable levels in CF stages by utilizing low-capacitance transistors in the OPS and keeping the predriver stage impedances at reasonably low values (i.e., compromise on beta-droop performance).

Differential Imbalance Distortion

If input stage differential amplifiers are not accurately balanced, a significant amount of second harmonic distortion will result. The theory involved in the generation of this distortion was discussed in Chapter 4. The incorporation of current mirrors is the complete remedy for this problem, with the additional benefit of increased slew rate.

VA Loading Distortion

In essence, VA loading distortion amounts to an impedance mismatch between the OPS and the VA, further complicated by the nonlinear loading characteristic of the OPS input impedance. The root problem here can either be a VA stage with excessively high output impedance or an OPS with an excessively low and overtly nonlinear input impedance.

In the case of VA designs utilizing active loading and beta-enhancement techniques, VA loading distortion can almost always be ignored as negligible if the OPS input impedance is anywhere near a reasonable value. Some amplifier designs incorporate a small-value resistor (typically about 100 ohms) between the VA and OPS predriver

transistors to increase the OPS input impedance. The more common practice is to install a few low-value resistors (that is, 4.7 to 10 ohms typically) in the emitter legs of the predriver transistors. In extreme cases, the output of the VA can be buffered with an additional transistor stage (almost always an EF topology). Although this modification will inject an additional stage of phase lag, the contribution is usually minor.

High-Power Distortion Mechanisms

There are several types of distortion mechanisms related to the high-voltage, high-current conditions inherent to audio power amplifiers. Many of these concerns will be addressed in Chapter 9, wherein power supply and grounding techniques will be thoroughly discussed.

All high-power distortion mechanisms have one thing in common; they result from IR drops or electrical fields that would be considered negligible in most low-power electronic circuits. When working with peak current levels in the 10- to 50-amp range, a straight piece of wire can no longer be thought of as the same electrical point from end to end; ground wires often carry signal voltages, and high-current junctions become unacceptable references due to their electrical turbulence.

Following a few common-sense rules can eliminate virtually all of these problems. First, establish a *high-quality ground* (HQG) point, sometimes called a *star point* or *star ground*. Run individual ground lines for high-current grounding applications to the HQG point, providing dedicated ground wires for signal return lines. Second, try to keep as much physical distance as possible between sensitive signal lines and high-current lines, high-current PC board tracks, or power transformers. Low-voltage signal wires should be shielded, and wiring running from the power supply to the PC board rail connections should be twisted together. Third, avoid using high-current connection points (junctions of RE resistors, common connection points of large filter capacitors, etc.) for critical reference points, such as signal ground or feedback loops.

Note: These considerations will be discussed in Chapter 12.

Capacitor Distortion

Much of what has been published regarding distortion mechanisms inherent to electrolytic capacitors is pure speculation. However, there

is a type of electrolytic charge-discharge capacitor distortion that can be significant at lower audio frequencies. The problematic areas in this respect are the input coupling capacitors [C1 and C2 in Figure 7.6(a)] and the DC blocking capacitor for the global NFB loop [C6 in Figure 7.6(a)].

Capacitor distortion becomes significant only when the applied frequency and capacitor value are such that a significant AC voltage can be measured across the capacitor. The simple solution to this problem is to increase the capacitor value until any significant AC voltage appearing across the capacitor is so low in frequency that it becomes irrelevant. For example, C6 in Figure 7.6(a) is much higher in capacity value than needed for the desired AC frequency response. The calculated capacity value was multiplied by approximately 5 to ensure that capacitor distortion would not become significant within the audio bandwidth. Luckily, input coupling capacitors and NFB DC blocking capacitors are typically low-voltage applications, so the large increases in capacitor values will have little effect on cost or size.

Fuse Distortion

In some amplifier designs, a protection fuse is placed in series with the speaker output connection, providing a measure of protection for speaker systems in the event of an OPS failure. If the current flow through the fuse is close to its maximum rating, the heating effect on the fuse element will cause it to vary in resistance. At low frequencies, wherein the thermal cycling of the fuse element can keep up with the frequency variations, a type of distortion will be produced, appropriately called *fuse distortion*.

Fuse distortion can be minimized by going to a higher-rated fuse, but then the protection is lost. In reality, protection fuses incorporated into the amplifier output line provide little protection anyway. Amplifier outputs should be protected with specialized electronic circuits that sense overload conditions and rapidly curtail output action. If the electronic protection circuit(s) fails, catastrophic OPS failure is still protected by the power supply rail fuses. Therefore, I see little purpose to incorporating output fusing at all.

Slew Rate

Slew rate is defined as the maximum rate of voltage change at the output of an amplifier. It is the most meaningful definition of an

amplifier's speed, but it is seldom provided as part of the formal specifications of a commercial amplifier. The term *slew rate* was originally applied to operational amplifiers, but it has been adopted for audio power amplifiers as well. Many audiophiles prefer to use the term *slew limit* in place of *slew rate* because, technically speaking, slew rate could be describing the rate of change of any dynamic voltage (i.e., not necessarily at the limit of an amplifier's capability). In contrast, the term *slew limit* clearly states its precise meaning, indicating this speed to be the maximum limit that the amplifier can process. Considering that the term *slew rate* has been used as the definitive speed parameter of operational amplifiers for a long time, I see no reason to not use it in the same way for audio power amplifiers.

Slew rate is usually expressed in terms of volts per microsecond, describing the fastest possible transition at the output of an amplifier. Slew rate can be used to define *rise time* (or *positive slewing*) and *fall time* (or *negative slewing*) independently, but in the case of audio power amplifiers, it is most commonly used as a singular expression to define the slowest of the two speeds. Slew rate is typically measured by applying a square wave signal to the input of an amplifier and measuring the rise and fall times at the output. Resistive loads (i.e., dummy loads) are used for loading purposes when performing this test.

There are several expressions that can help us relate slew rate to sine wave frequencies and power bandwidth:

$$\text{Maximum frequency of sine wave} = \frac{\text{slew rate}}{6.28 \times E_{\text{out(PK)}}}$$

For example, assume you have an amplifier with a slew rate of 30 V/ μ s and you want to know the maximum sine wave frequency that it can sustain at an output voltage of 35.3 volts RMS. 35.3 volts RMS works out to about 50 volts peak (I made this easy on myself). 50 volts multiplied by 6.28 comes out to 314. The term "30 V/ μ s" is another way of saying "30 V divided by 1 μ s," or 30,000,000. 30,000,000 divided by 314 equals 95,541 Hz, or about 95 kHz. Therefore, an audio power amplifier with a slew rate of 30 V/ μ s can accurately reproduce a sine wave frequency of 95 kHz at a 35.3-volt RMS output level. Note that if the output amplitude doubled (i.e., increased to 70.7 volts RMS), the slew rate would also have to double to reproduce the same 95-kHz sine wave frequency.

If you need to know the slew rate of a given sine wave voltage, the equation is:

$$\text{Sinusoidal slew rate} = 6.28 \times \text{frequency} \times E_{\text{sine(PK)}}$$

For example, calculating the previous problem in reverse, we would like to calculate the slew rate of a 95-kHz sine wave at a 35.3-volt RMS level. Again, 35.3 volts RMS equals 50 volts peak. Therefore, 6.28 multiplied by 95,000 multiplied by 50 comes out to 29,830,000, or approximately 30 V/ μ s.

To put these relationships into perspective, the following short list provides some common output power levels and describes the required slew rate for an 80-kHz power bandwidth. The majority of audiophiles consider these slew rate specifications to be the ultimate requirements for any type of program material, including CD and DAT formats. All loads are assumed to be 8 ohms.

32 watts RMS	= 11 V/ μ s
64 watts RMS	= 16 V/ μ s
125 watts RMS	= 23 V/ μ s
250 watts RMS	= 32 V/ μ s
500 watts RMS	= 45 V/ μ s
1000 watts RMS	= 64 V/ μ s

In the case of 4-ohm loads, the power ratings of the previous list can be doubled (that is, 1000 watts RMS into 4 ohms requires a slew rate of 45 V/ μ s, etc.).

Improving Slew Rates

In the majority of amplifier designs, slew rates are already more than adequate. Occasionally, however, there are some circumstances that arise



It is accepted as an axiom in the audio fields that "faster is better," and it can be counted on that the faster of two almost identical amplifiers will be the better-selling model. It is obvious, however, that this can be taken to ridiculous, and even detrimental, extremes. For example, it would be foolish to design a 50-watt RMS amplifier with a 50-V/ μ s slew rate, and the chances of this amplifier suffering from high-frequency instability would certainly be much greater than a similar model designed to provide the more appropriate 16-V/ μ s response.

wherein the slew rate of an amplifier needs to be improved upon (most often, this will be in regard to high-power applications). A good understanding of slew rate is also necessary when constructing any kind of custom amplifier project.

Slew rate limitation in audio power amplifiers is a function of the interaction of the input and VA stage. In simplest terms, slew rate will depend on supplying the current needs of the compensation capacitor CC and will usually be limited by VA current limitations or differential tail current limitations. It should be noted that two-pole compensation techniques could have a significant effect upon slew rate and require an adjustment.

Figure 7.8(a) illustrates a circuit to test the slew rate of a high-performance input and VA stage similar to that of Figure 5.6(a). Note

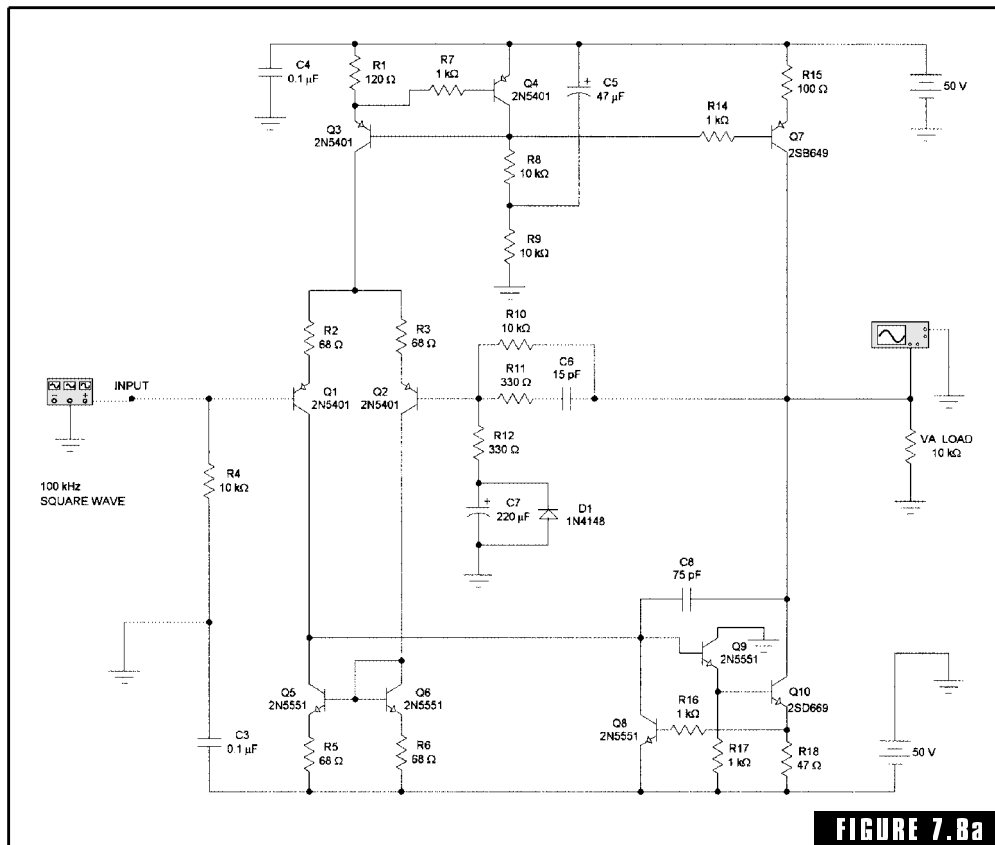
FIGURE 7.8a
High-performance input and VA tested for slew rate.

that a 100-kHz square wave has been applied to the input and a 10-k Ω resistor is used for a VA load. The compensation capacitor is C8.

When a positive-going transition is applied to the base of Q1, it will turn off. Current will be forced to flow from the current mirror (Q5), through C8 to the VA constant current source Q7. In this case, the maximum current flow through C8 is limited by the VA constant current source. When a negative-going transition is applied to the base of Q1, it will turn on. Now current will flow from the VA transistor (Q10) through C8, through Q1, and finally to the differential tail current transistor Q3. The maximum current flow through C8 is limited in this case by the differential tail current source. Note that the VA current source limits slew rate in one direction, but the tail current source limits slew rate in the other direction. This is the cause of asymmetrical slewing in many amplifier designs.

Note: Asymmetrical slew rates are not a bad thing as long as the slowest of the pair is fast enough! Symmetrical slewing does look better on an oscilloscope, but in this context, oscilloscope patterns have little to do with good sonics.

To improve the slew rate of the circuit in Figure 7.8(a), the obvious answer is to either increase the current output of the current sources or decrease the value of C8. Either method should be approached with caution since both modifications will significantly affect Nyquist stability. A peculiar little idiosyncrasy of either of these approaches involves transistor Q7. A positive-going rise at the VA output will couple a positive pulse to the base of Q7 through its own internal collector-base capacitance. Depending on the transistor type used, this could cause Q7 to turn off at the same instant that the rapid rate change requires it to turn on. The best remedy for this problem is to convert to an FET constant current source (FETs don't exhibit an equivalent gate-drain capacitance).

The output waveforms of Figure 7.8(a) are illustrated in its associated oscillogram in Figure 7.8(b), showing the positive slew rate to be about 26.6 V/ μ s and the negative at about 40 V/ μ s. Since the VA current source is set at a higher current level than the differential tail current source, the slower positive slew rate is almost certainly a result of the collector-base capacitance of Q7, so a JFET constant current source would probably increase the positive slew rate up to near symmetry. However, the moti-

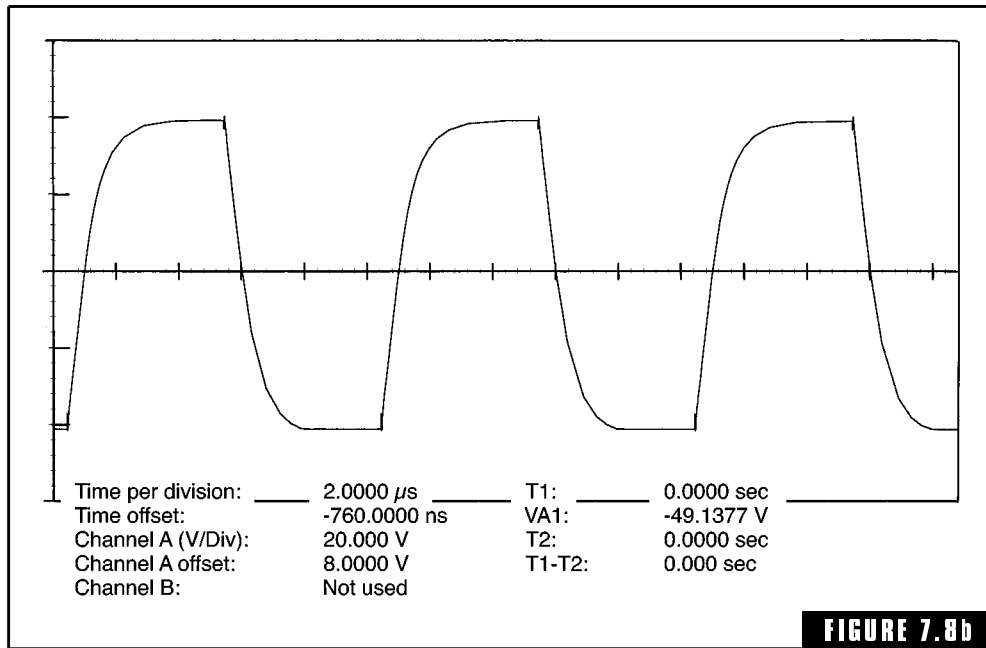

Oscilloscope that illustrates the slow rate performance of the circuit in Figure 7.8(a).

vation for making such a circuit modification would be to utilize this design for a power amplifier in excess of 150 watts at 8 ohms.

Figure 7.9(a) and its associated oscilloscope in Figure 7.9(b) illustrate the improved slow rate performance of a mirror-image topology. The VA stage of Figure 7.9(a) is actually a *cascode loaded, push-pull, complementary class A output circuit*. For a class A stage to function, it obviously has to be provided with quiescent bias, which is established by the collector voltage of Q1 for the upper half of the VA stage and the collector voltage of Q3 for the lower half. The collector voltages of Q1 and Q3 are ultimately established by their associated tail current sources, so the tail current sources of Q9 and Q10 are the major controlling factors for the I_q of the VA stage. The resistance values of the current mirror degeneration resistors (R1, R2, R7, and R8) and differential degeneration resistors (R3, R4, R5, and R6) will also have a minor role in setting the VA I_q since they will also affect minor changes in the collector voltages of Q1 and Q3. With the component values shown, the VA I_q of the circuit in Figure 7.9(a) will be about 44 mA.

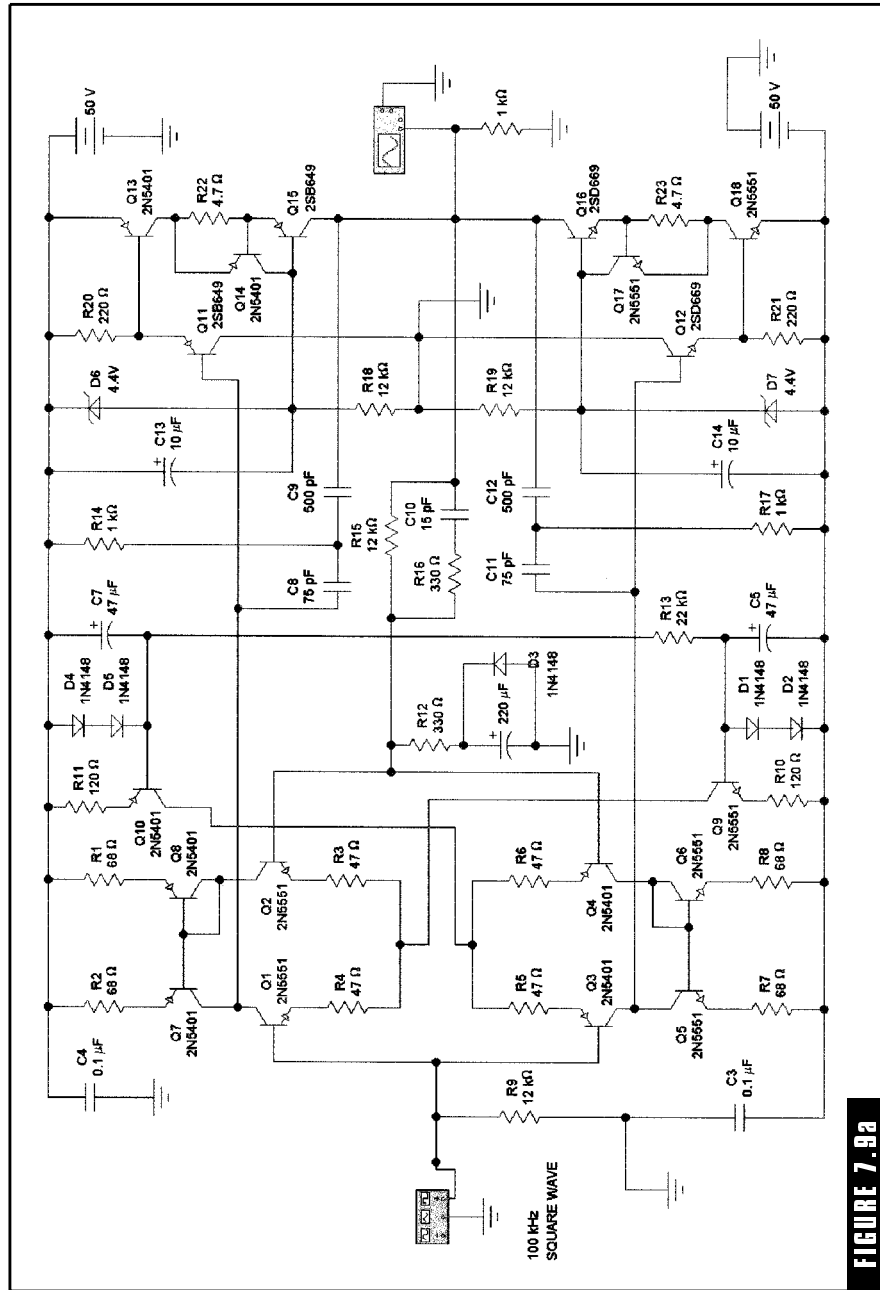

High-performance input and VA in Figure 7.8(a) tested for slew rate.

Since the VA is operating in push-pull mode with such high current reserves, current flow through C8 and C11 (the collective dominant-pole capacitor) becomes a primary function of the VA current. However, it should be remembered that there are now two compensation capacitors requiring a current supply and that the two-pole compensation feature also adds to the current demand. Even with these shortcomings, the oscillogram in Figure 7.9(b) shows a very healthy symmetrical 55-V/ μ s slew rate (the push-pull feature of the VA forces the slew rate to be symmetrical). The high-current capabilities of the VA stage also make it much less immune to OPS impedance variations [note the VA load resistor in Figure 7.9(a) is 10 times lower than the load resistor used in the test circuit of Figure 7.8(a)].

Slew rate improvement in mirror-image topologies is a simple matter of adjusting the tail current sources for the differential input stages. Care should be taken when making such changes because the differential tail currents affect the input gm which, in turn, affects open-loop gain. Invoking changes in open-loop gain without adjusting the compensation factor can lead to severe instability problems. If this design is modified for high slew rate–high current operation, the VA current sense resistors R22 and R23 may need to be slightly reduced.

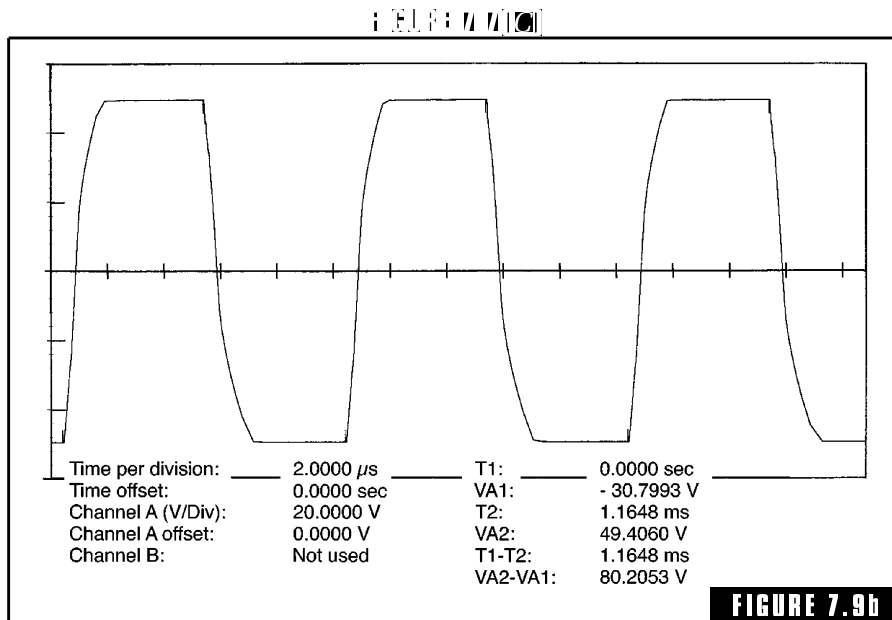

FIGURE 7.9b
Oscillogram that illustrates the improved symmetrical slew rate performance of the high-performance input and VA stages of Figure 7.9(a).

This page intentionally left blank.

Amplifier and Loudspeaker Protection Methods

It was once stated that a DC-coupled high-power audio amplifier is an accident waiting to happen. Modern high-quality audio systems demand power outputs high enough to arc-weld while being docile enough to protect sensitive speakers. Commercial amplifiers must be reliable enough to withstand long periods of maximum output and physical abuse and safe enough to place in either a professional stage environment or domestic family environment. I believe professional audio has accomplished these goals admirably, although I could not have made this statement in good conscience only a few short years ago. It is one thing to design a power amplifier that performs well; it is an entirely different thing to keep the amplifier performing in a reliable fashion. Part of this responsibility lies with reliable design techniques, while the remaining responsibility is placed on the protection circuitry. Without appropriate protection circuitry, it is simply impossible for any solid-state power amplifier to be considered reliable.

But what is considered appropriate? Of paramount importance is safety. There can be no short cuts, compromises, or divisive opinions in this area. Any amplifier in violation of nominal safety standards

should be fixed or dismantled—there are no other options! The next priority is internal protection. This includes all of the feedback, current-limit, fusing, and thermal monitoring circuits to prevent an amplifier from self-destructing. Third, an amplifier should be protected from any reasonable overload condition or external connection error. Mistakes can be made by anyone—from the seasoned professional to the novice. Power amplifiers should never be constructed without overload (thermal and current) and short-circuit protection. The various esoterics who advocate the design of OPSs without short-circuit protection need to take an advanced course in Murphy's law. This is a very unwise practice from any practical perspective. Finally, an amplifier should be protected from destroying expensive speaker systems in the event of an OPS failure. Speaker protection is relatively easy and inexpensive. Cheap insurance is better than buying new speaker drivers any day of the week!

Safety Protection Considerations

Large audio power amplifiers can be harbingers of very dangerous and lethal power levels. This is especially true of many European models that operate from 240 VAC mains supplies. From the physical perspective, there are numerous common-sense protection methods that should be observed. For example, the line cord should be rugged and oversized to handle the formidable line surges. The cabinet should be solid and well ventilated, but it should not contain any holes large enough for a finger to poke through (even a child's finger). It only takes a few moments to coat internal high-voltage points with a little silicone RTV or similar insulator. This isn't a required safety measure, but it can save injury or loss if someone inadvertently drops such items as wire rim glasses, key chains, coins, or even chewing gum wrappers (i.e., the aluminum foil) on the top of the amplifier where they can partially or totally fall through the ventilator slots. Obvious faults such as frayed power cords or loose connectors should be repaired immediately.

In my experience, the type of insulation used in hook-up wire is too often taken for granted. Many types of rubber insulation (i.e., typically used for automotive or marine applications) will melt when exposed to some of the nominal temperatures encountered inside a large audio power amplifier. While it is not common for heatsinks to reach such

temperatures, it is normal operating procedure for power resistors and vacuum tubes to do so.

It is always good to consider safety techniques involving the servicing of power amplifiers during the construction phase. (It isn't nice to kill your local amplifier repairperson!) Again, this is a situation wherein a little time and silicone RTV and/or heatshrink tubing can come in handy. Try to terminate high-voltage wiring in a conventional and expected method. One large amplifier manufacturer routinely connects the mains power through two thermal switches mounted to the OPS heatsinks. This kind of construction is not only dangerous to service personnel but it presents a very real hazard of placing the heatsinks at the mains potential in the event of physical damage. Keep the mains power close to the power transformer and power switch; avoid control or protection schemes that utilize the mains power. Some manufacturers place the line cord, power transformer, AC line fuse, power switch, and/or circuit breaker in one small neat area in the rear of the amplifier enclosure. This is definitely a good practice.

Figure 8.1 illustrates the recommended areas for the incorporation of safety fuses. A line fuse or mains circuit breaker is mandatory. A circuit breaker is more convenient, and it eliminates the possibility of someone's replacing the line fuse with a fuse of the wrong current rating. Unfortunately, circuit breakers are more expensive than fuses. Rail (or HT) fuses are mandatory if fusing is not incorporated into the power amplifier OPS. Even if the amplifier output is fused, it is still a good idea to incorporate rail fuses to protect the amplifier circuitry in the event of an OPS failure. The fuses installed in the secondary of the power transformer (labeled "sec. fuses" in Figure 8.1) are not mandatory, but they will save the power transformer from destruction due to a partial short circuit in the bridge rectifier. The line fuse and secondary fuses should be the slow-blow types to withstand the high surge currents drawn by the reservoir capacitors during power up.

Electronic Overload Protection for Semiconductor Devices

Overload in the context of this discussion means an excessive voltage-current condition applied to a semiconductor device that is beyond its published operational parameters. Attempting to protect semiconductor

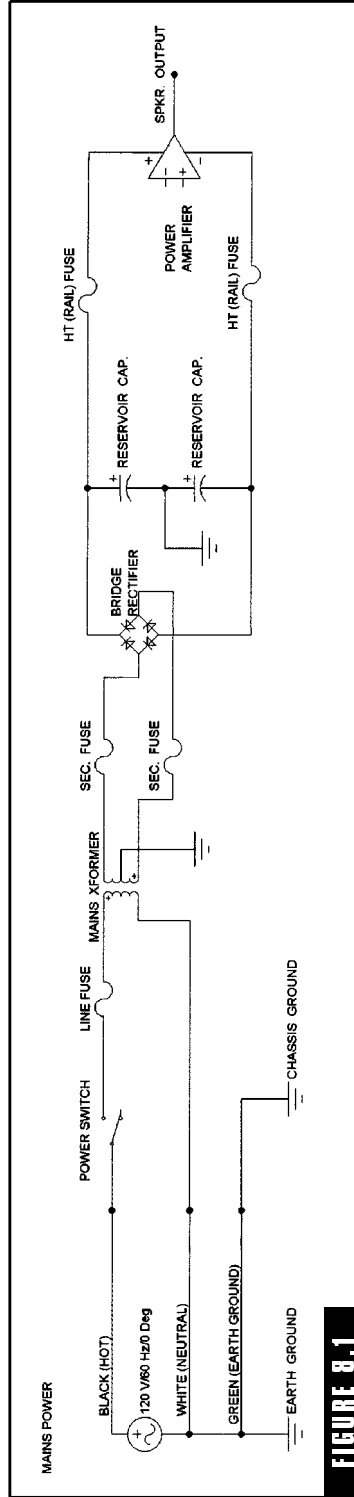

FIGURE 8.1

Recommended fuse protection for a typical audio power amplifier.

devices with fuses is not a viable option. A typical semiconductor device will fail from an overcurrent condition long before a fuse element has time to melt. Therefore, reliable overload protection must rely on various electronic methods of rapid response.

In previous chapters, we examined several methods of protecting the VA stage transistors from overcurrent conditions. The primary theme of this section will focus on OPS overcurrent protection since this presents the greatest threat to amplifier reliability by a very wide margin.

Protecting Bipolar Junction Transistors

It is a rather obvious fact that we shouldn't ever exceed the primary breakdown parameters of BJTs (or any other electronic device, for that matter). Primary breakdown parameters are those specifications provided by transistor manufacturers describing maximum limits of voltage, current, and temperature relative to a specific power transistor, usually termed as *absolute maximum ratings*, or similar language. For the most part, these specifications are self-explanatory and relatively easy to adhere to.

Regarding audio power amplifiers, a parameter of frequent confusion is V_{CE} , which is the maximum voltage from the collector to emitter. The general rule is to choose transistors with a V_{CE} rating of at least twice the sum of the power supply rails. This is to provide some additional insurance against damage from reactive loads. For example, if you were building an amplifier utilizing positive and negative 40-volt rails, the V_{CE} ratings of the transistors should be at least 160 volts [that is, $(40 + 40) \times 2$]. The only exception to this rule exists when a small-signal transistor is isolated from one of the power supply rails by a cascode stage. In these situations, the V_{CE} rating of the small-signal device need not be much in excess of the singular power supply rail voltage.

BJTs suffer from a very nasty complication referred to as *secondary breakdown*. Secondary breakdown results as a complication of localized hot spots that form internally on the transistor's silicon wafer material. It happens when the operating voltages become large enough to introduce the beginnings of *Early effect* (reducing the effective base width), creating a diversification of current distribution. As these effects increase, their combined influence promotes an occasion of thermal avalanche breakdown, and the transistor goes on

to semiconductor Heaven. Depending on the transistor type and internal geometry, secondary breakdown currents can be as low as 150 mA and as high as 3 amps.

Secondary breakdown causes a complex failure pattern that cannot be represented with a simple parameter definition. Consequently, semiconductor manufacturers provide a graphical analysis of safe transistor operation, called a *safe operating area* or (SOA) chart. Figure 8.2 illustrates an SOA chart for a hypothetical transistor. The upper curve represents the maximum load line for the transistor while the bottom curve represents the area of secondary breakdown. The area of concern is below the intersection point of the two curves, called the *second breakdown region*. For example, the load line at 100 volts shows the maximum current to be about 2 amps (obviously, this is a 200-watt transistor). However, the second breakdown curve indicates that the transistor will go into secondary breakdown if the current exceeds about 1.25 amps at 100 volts. Further up on the load line, however, it is permissible to operate the transistor at its full rated power dissipation. The operating region to the left of both curves is the safe operating area. SOA charts, like the one illustrated in Figure 8.2, allow us to plot a “protection locus,” defining the allowable current-voltage conditions of a specific OPS design. This is necessary to develop an electronic protection circuit that will stay within the designated boundaries.

Figure 8.3 illustrates the first step in developing a protection method. For discussion sake, assume the OPS will operate from dual 35-volt power supply rails. The load line for 8-ohm loads is plotted by placing point *X* at 35 volts and calculating the maximum current flow through the load at 35 volts. In this case, 35 volts divided by 8 ohms equals about 4.3 amps. Therefore, point *E* is placed on the *Y* axis at 4.3 amps, and a diagonal line is drawn between points *E* and *X*. This line represents all of the possible voltage and current conditions that can occur with a resistive load of 8 ohms. The same procedure is followed for 4-ohm loads, producing line *F* and *X*. Finally, since speaker loads represent reactive loads, we must also take this into consideration. Worst-case reactive conditions could cause voltage increases up to the value of the opposing power supply rail, so the 35 volts on the *X* axis is doubled, providing point *R* at 70 volts. A final slope is drawn from the worst-case voltage condition (point *R*) to the worst-case current condition of 4 ohms (point *F*). The protection locus, representing the allowable conditions of

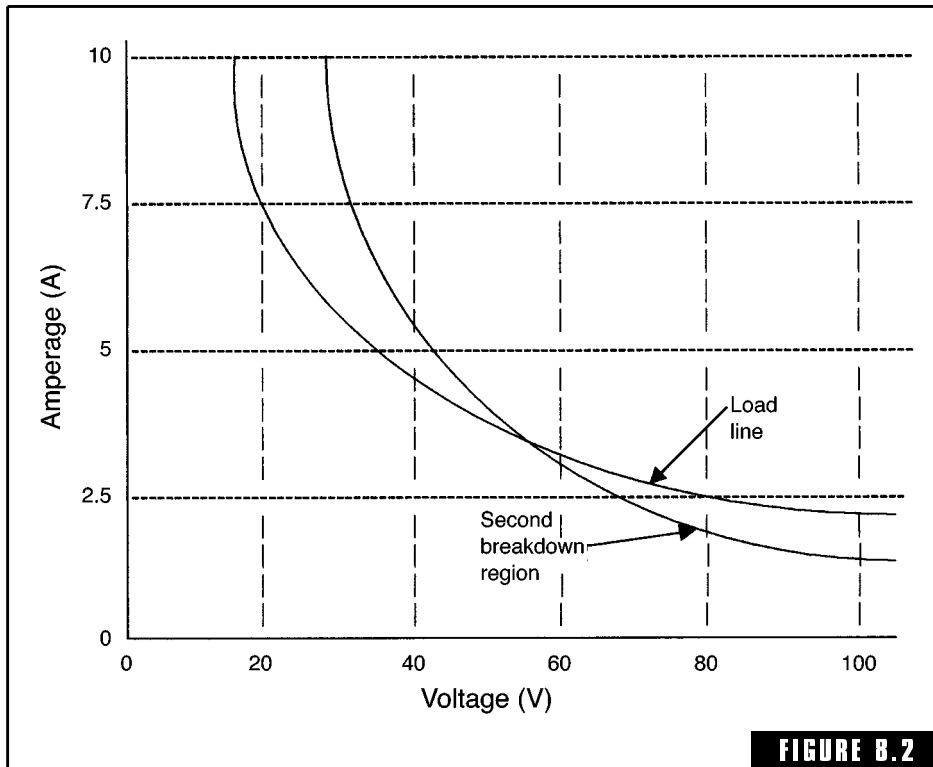

FIGURE 8.2

A safe operating area (SOA) chart for a hypothetical bipolar junction transistor.

the electronic protection circuitry, should be to the left of slope FR , and this will ensure the OPS will operate within the SOA at all times.

As first thought, it would seem that adequate OPS protection would be afforded by simply protecting the output transistors from exceeding a maximum current setting. Unfortunately, things are rarely as simple in the field of audio electronics. Figure 8.4 shows the protection locus provided by simple current-limit protection set at about 5.1 amps. A horizontal line is plotted from the 5.1-amp point on the Y axis extending to the rail voltage potential on the X axis. The resulting rectangular protection locus provides a graphical representation of all allowable voltage-current conditions that will not cause an activation of the protection circuitry.

Evaluating Figure 8.4, note that the entire 8-ohm resistive slope (line EX) is within the protection locus. The 35-volt power supply rails represent the peak voltage that can appear across the load, so a

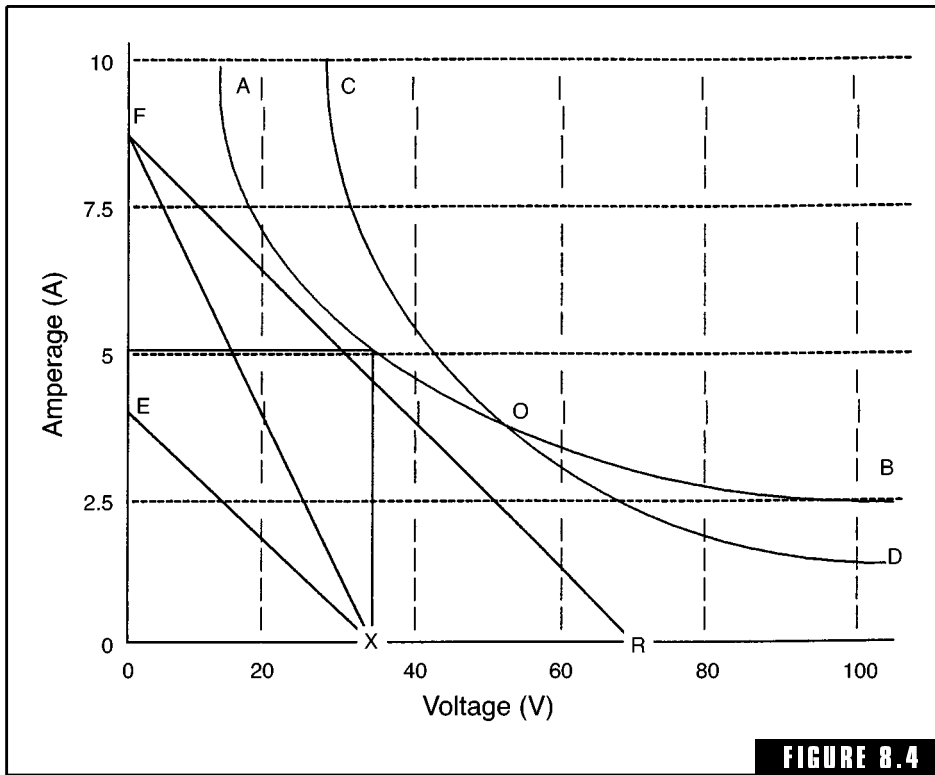

Plot of the response of simple V-I limiting protection circuit.

bilities of the OPS, especially in the cases of low-impedance loads and/or highly reactive loads.

Figure 8.5 illustrates a typical EF OPS incorporating a simple current-limiting protection circuit. RE1 functions as a current-sensing resistor, with its voltage drop being proportional to the emitter current of Q3. RE1's voltage drop is applied to the voltage divider network of R3 and R1, providing a scaled proportional voltage to the base of protection transistor Q5. If Q3's emitter current increases beyond the preset limit, the voltage increase at the base of Q5 will cause its collector-emitter impedance to drop. This action effectively shunts all additional drive current away from Q1's base, placing a maximum ceiling on Q3's emitter current regardless

QUICK TIP

Actually, this protection locus is a little too close for comfort—the current limit should be set a little less than 5 amps so the protection locus could not come close to touching the maximum load line.

of the load conditions (even down to a short-circuit condition). As soon as the overload condition is removed, the amplifier automatically goes back into normal operation. The complementary action of Q4 and Q6 is identical to that described for Q3 and Q5.

Blocking diodes D1 and D2 are to inhibit the protection transistors Q5 and Q6 from conducting during the wrong half-cycle. This could happen if the voltage drops across the RE resistors became high enough to cause the collector-base junctions of Q5 and Q6 to be forward biased.

The protection circuit of Figure 8.5 is set to limit current at about 4.5 amps under nominal conditions. Figure 8.5, like all protection circuit designs in this chapter, is a complete and functional circuit. Although I am utilizing different transistor types (actually, improved transistor types), this particular protection circuit is the same design that is currently being incorporated into a \$550 keyboard amplifier by a major manufacturer.

Simple current limiting is utilized in many modern amplifier designs. It is especially suitable for dedicated amplifier applications, wherein the amplifier is permanently connected to a single speaker system without the possibility of being exposed to significantly variable load impedances. Examples of this are many types of musical instrument amplifiers and powered speaker systems.

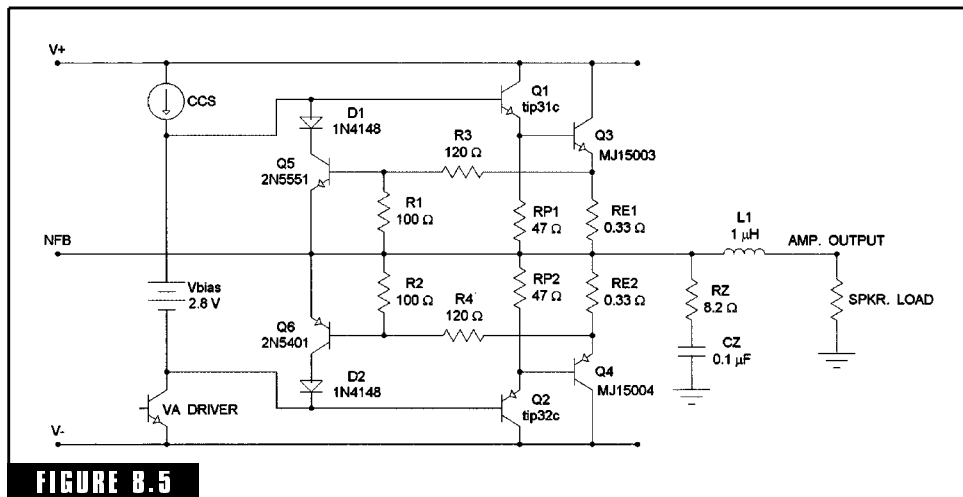

FIGURE 8.5

OPS incorporating simple V-I limiting protection circuit.

Single- and Dual-Slope Protection Methods

Figure 8.6 represents a greatly improved and much more practical type of OPS overload protection. The protection locus, represented by line *FS*, is now a slope, encompassing almost the entire SOA area. Note that 8-ohm, 4-ohm, and 4-ohm reactive loads are not restricted by the protection locus, allowing maximum power output without compromising the reliability of the protection circuitry. An electronic circuit providing such a protection locus requires the simultaneous monitoring of both current and voltage conditions.

The single-slope V-I limiting circuit of Figure 8.7 can provide the slope response as illustrated in Figure 8.6. It is almost identical to the protection circuit of Figure 8.5, with the exception of the additional resistors R5 and R6. These two resistors connect to the dual rail supplies and provide a continuous DC offset to the bases of the protection

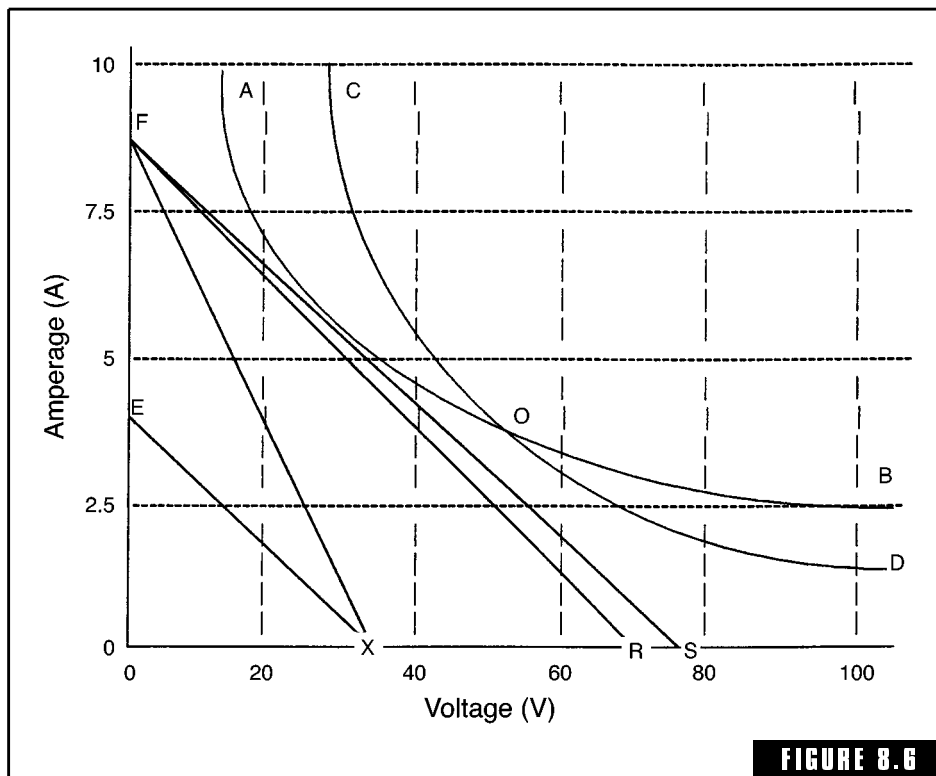
**FIGURE 8.6**

Plot of the response of single-slope V-I limiting protection circuit.

transistors. When the output rail is near ground potential, the DC offsets are stable. However, when the output rail begins to vary in proportion to signal changes, the DC offsets “vary in proportion to the difference in potential between the rail voltages and output rail.” For example, if the rail voltages are dual 40-volt supplies and the output rail is setting at 0 volts, there will be a 40-volt potential between the output rail and the positive power supply rail. This will cause some steady-state DC offset to be applied to the base of Q5 through the action of the voltage divider network of R5 and R1. If a positive signal voltage is applied to the OPS causing the output rail to climb to +32 volts, the difference between the output rail and the positive power supply rail will decrease to only 8 volts. Consequently, the DC offset at the base of Q5 decreases to a value of only 20 percent of what it originally was. The result is an interaction of current and voltage variables, providing a sloped response much more conducive to OPS efficiency.

The protection circuit of Figure 8.7 is the same circuit I incorporated into the hybrid amplifier design of Figure 7.6(a) of the previous chapter. The entire OPS design of Figure 8.7 is a good design for amplifiers up to about 80 watts RMS.

Manufacturers have been motivated to go to more complex forms of OPS protection as a means of improving the amplifier size versus output power ratio and decreasing costs. Although single-slope OPS pro-

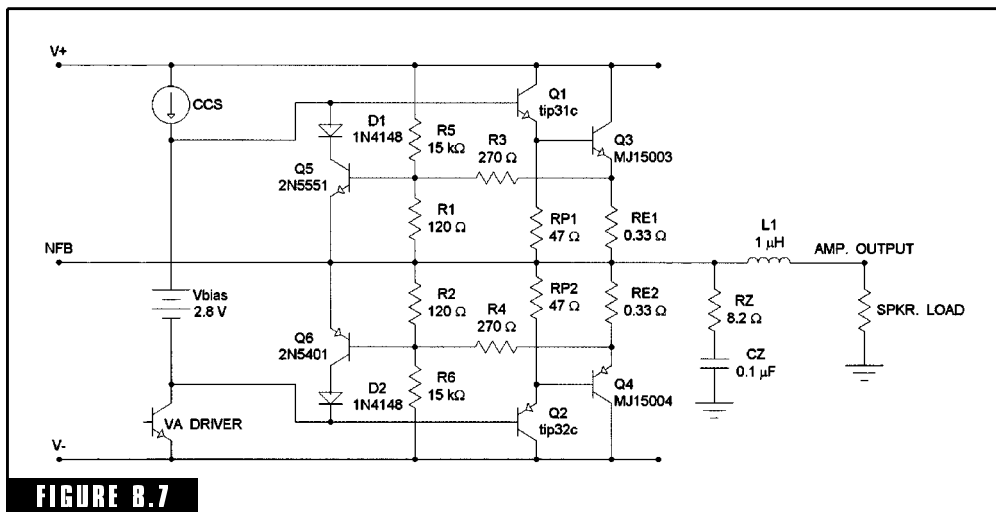

FIGURE 8.7
OPS incorporating single-slope V-I limiting protection circuit.

tection is highly practical, it is possible to reduce the number of output complementary pairs in larger amplifiers by utilizing a greater percentage of the available SOA region. Figure 8.8 illustrates how this can be accomplished. The protection locus (line *FYZ*) has been modified into a dual-slope response, utilizing a break point at *Y* and providing increased operational area in the higher-voltage regions (note how this method increases the protection locus beyond the 100-volt range). Higher-voltage operation can be accomplished with single-slope protection, but the available low-voltage, high-current SOA must be reduced in the process. Imagine extending line *YZ* to the *Y*-axis line; the maximum current at 0 volts would only be about 3 amps. Dual-slope protection provides the best of both worlds, allowing extended high-voltage operation without reducing the high-current maximums of optimum single-slope protection.

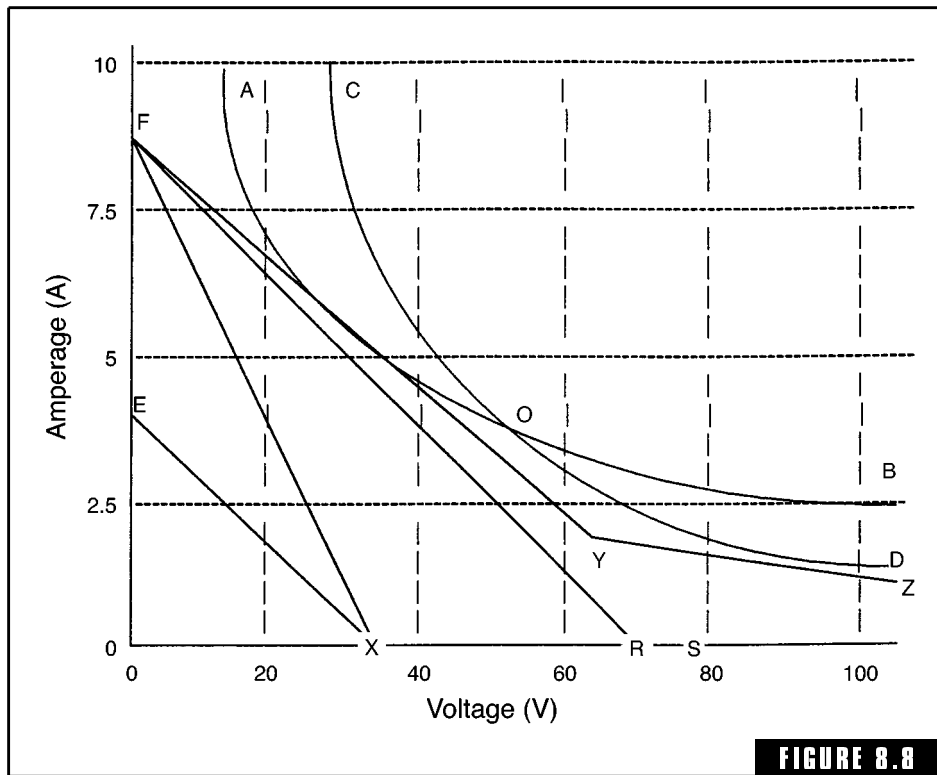

FIGURE 8.8

Plot of the response of dual-slope V-I limiting protection circuit.

The protection circuit of Figure 8.9 illustrates how dual-slope protection response can be accomplished. Note that Figure 8.9 includes an additional paralleled output pair; dual-slope protection is generally impractical for single pair output designs. The operational principle of the protection circuit is essentially the same as for Figure 8.7, but the two additional zener diode legs provide a voltage-controlled slope augmentation. With the output rail at 0 volts, zener diode D3 clamps the voltage across R7 and R1 at about 17 volts. Under these conditions, the offset voltage at the base of Q5 is much lower than it would be without the zener leg, providing the protection response of line *YZ* in Figure 8.8. Whenever the voltage on the output rail increases to about +20 volts, diode D3 drops out of the zener region, causing the zener leg to look like an open circuit. At output rail voltages of +20 volts or higher, the protection circuit exhibits the response of line *FY* in Figure 8.8, functioning identically to the circuit of Figure 8.7 (note that R5 and R7 of Figure 8.9 add up to the same resistance as R5 in Figure 8.7). The complementary action of Q6 and its associated circuitry is identical in providing protection during negative signal excursions.

The entire OPS design of Figure 8.9 is excellent, providing over 130 watts RMS into 8-ohm loads and about 200 watts into 4-ohm loads

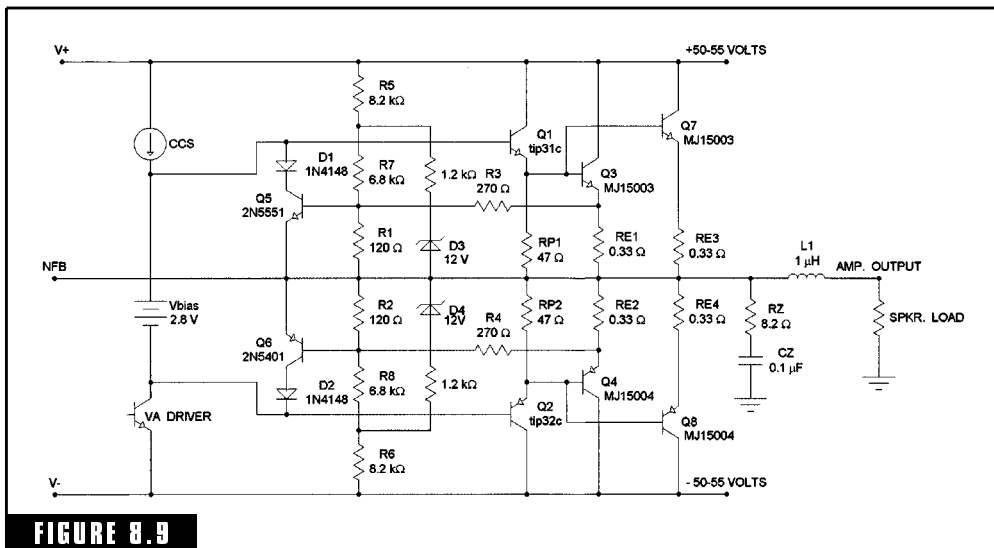

FIGURE 8.9 OPS incorporating a dual-slope V-I limiter.

(assuming realistic losses and typical power supply efficiencies). As shown in Figure 8.9, OPS protection circuits usually monitor only one set of RE resistors since it can be assumed that the current through multiple output pairs will be equally shared. This is not a rash assumption, providing the protection locus is not riding on the hairy edge of going into the secondary breakdown region. In the past, some manufacturers have monitored multiple sets of RE resistors, producing a summed current monitor signal to the protection circuits. In my opinion, this is an unnecessary exercise in redundancy for well-designed OPSs, and I am not aware of any proof that OPSs utilizing this technique are any more reliable than conventional OPSs.

Multislope Protection Methods and Variants

During the 1970s and 1980s, there were literally hundreds of individualistic OPS protection circuits incorporated into many new design topologies. Almost all of these new methods were prompted by the desire to squeeze more power out of X number of output devices, with power being the ultimate specification of a power amplifier's worthiness. With the rise of subjectivism, audiophile attitudes were focused back toward the real attributes of sonic quality, such as distortion, noise, and slew rate. I consider this to be one of the really positive attributes of subjectivism; it has forced us to go back to the basics in search of a better sonic experience.

The ultimate goal of all OPS protection methods is to emulate the actual SOA curves, or equally beneficial, to emulate the semielliptical reactive load line. While this objective sounds rather simple, in reality it becomes enormously complex, impossible to thoroughly test, and inaccurate within the confines of simulation models. The problem is due to the inability to effectively standardize audio loads. A power amplifier can be called upon to power anything from a pair of boom-box speakers to stadium-capacity exponential horn drivers. Nominal load impedances can be anything from 2 ohms to 16 ohms, with virtually any measure of reactive content. This all equates to an infinite number of loading conditions. Therefore, in theory, manufacturers would have to spend "infinite" time in thoroughly testing OPS protective circuitry. Not only is this approach quite impossible, but any attempt to even approximate it becomes impractical and excessively costly.

When we can begin to appreciate the complexity of the problem, we can begin to understand the methodology of many ex-manufacturers. During the seventies and eighties, when CAD modeling and CAM production techniques were not available to the average power amplifier manufacturer, power amplifiers were marketed with what the manufacturer hoped would eventually turn out to be a reliable protection system. From one extreme, manufacturers were squeezed to provide more watts per dollar, while from the other extreme, they were pressured to produce a reliable product. Unfortunately, watts per dollar can be achieved immediately, but reliability takes time to prove itself. The end result was that a lot of amplifiers blew up during this period, and this unfortunate situation led to much of the distrust in solid-state amplifiers within subjectivist circles today. However, it also provided a few time-tested protection circuits that did a reasonably good job of emulating reactive load lines. In general, these circuits are referred to as *multislope V-I limiters*.

Figure 8.10 illustrates a very common form of multislope V-I limiter. This circuit operates independently of the power supply rails because the principle is to emulate the general nature of most SOA curves. It accomplishes this task reasonably well, and in comparison to other major protection schemes, it provides good OPS protection for the broadest range of OPS designs and power supply voltages. This basic circuit design was developed in the 1970s and is still incorporated in many modern OPS designs. I like to use this protection circuit (or a variant) in public address amplifiers and musical instrument amplifiers because it limits the OPS to very low currents during short-circuit conditions. There are two advantages to this kind of current-foldback response. First, in applications where it is inevitable that speaker systems will be connected or disconnected while the amplifier is powered (never a good idea, but nevertheless, inevitable in public address and musical instrument amplifiers), arcing is reduced to a minimum while connections are being made and broken. Second, if the amplifier output is accidentally shorted for a long period of time, the OPS won't overheat under normal conditions.

In basic theory, the circuit of Figure 8.10 functions like a simple current limiting circuit. As the voltage across the RE resistors reaches a maximum limit (corresponding to a maximum emitter current limit of the output transistors), the protection transistors will turn on and

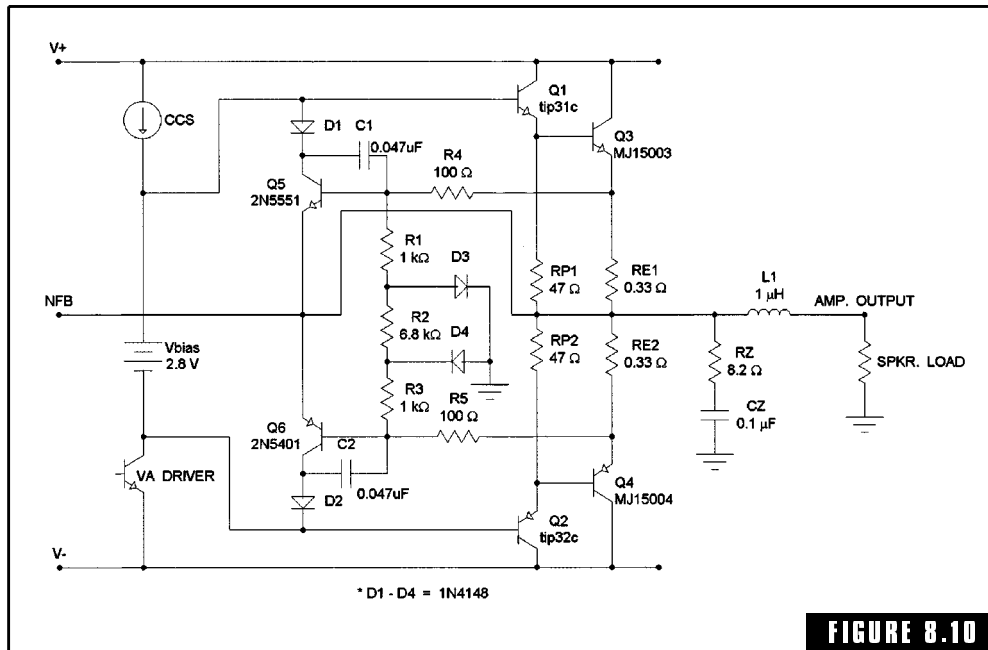

FIGURE 8.10

OPS incorporating a multislope V-I limiter.

divert drive current away from the predrivers. This holds the maximum OPS current at a ceiling limit. However, unlike simple current limiting, the bases of the protection transistors are referenced to circuit common through two steering diodes, D3 and D4, instead of the output rail. In effect, this allows the protection transistors to monitor the load impedance relative to the output current.

As a means of understanding the operation of the protection circuitry in Figure 8.10, we can analyze it with the OPS under several loading conditions. First, assume the output is short-circuited to circuit common (i.e., ground in most amplifier designs). As a positive signal voltage is applied to the OPS, all of the output voltage must be dropped across emitter resistor RE1. As soon as the voltage across RE1 approaches 0.7 volt (corresponding to a little over 2 amps of OPS current), Q5 is forward biased and begins limiting the maximum output current at this level.

Now, assume a 1-ohm load is connected to the output. Also assume a positive voltage is applied to the OPS sufficient to cause about 3 volts to be dropped across the 1-ohm load. Under these con-

ditions, RE1 and the 1-ohm load form a simple voltage divider network. Since 3 volts are being dropped across the 1-ohm load (corresponding to about 3 amps of OPS current flow), RE1 must drop about 1 volt ($3 \text{ amps} \times 0.33 \text{ ohm} = 0.99 \text{ volt}$). By adding the voltage drops across the load and resistor RE1, it can be determined that the emitter voltage of Q3 (in reference to circuit common) is approximately 4 volts. In coincidence, R4, R1, and D3 form another voltage divider. The entire emitter voltage will be dropped across this voltage divider also, with R4 dropping about 10 percent of the voltage appearing across R1. For discussion purposes, we can assume the forward voltage drop across D3 is always 0.7 volt. This leaves about 3.3 volts to be divided between R4 and R1, which comes out to about 3 volts across R1 and 0.3 volt across R4. Note that the voltage polarity across R4 causes it to buck the voltage developed across RE1. Since about 1 volt is across RE1 and 0.3 volt across R4, the base-emitter voltage of Q5 comes out to 0.7 volt. This is the approximate turn-on voltage of Q5, so the maximum output current of the OPS will now be held at about 3 amps.

If you perform the same series of calculations for a 2-ohm load, you will discover that the maximum OPS current for a 2-ohm load is approximately 6 amps. As previously shown, the protection circuit of Figure 8.10 will limit the OPS current to about 2 amps under a short-circuit condition. With 1-ohm and 2-ohm loads, the current will be limited to approximately 3 amps and 6 amps, respectively. This all boils down to the effect of monitoring the load impedance (by using a reference voltage divider in comparison to the output rail voltage) and limiting the OPS current accordingly. With the values shown, 4- and 8-ohm loads won't be limited at all (unless the reactive nature of the loads causes them to drop significantly below their nominal impedances). The complementary protection action is provided by protection transistor Q6 and its associated circuitry.

D3 and D4 are steering diodes, blocking leakage current from opposing signal cycles (i.e., they won't allow current to flow through the negative protective circuitry during positive cycles and vice versa). C1, C2, and R2 provide stability during current limiting action.

The protection circuit of Figure 8.10 is relatively easy to design or modify for special applications. It suffers the disadvantage of not having any reference to the power supply rails, so the value of the RE

resistors must be chosen to place the protection locus within the appropriate area of the SOA.

Figure 8.11 is a variant of Figure 8.10. The basic operational principles are essentially the same, so I won't be redundant in providing a detailed circuit description. This protection scheme is a little more suitable for large, high-power amplifiers, although a modified version of Figure 8.10 also appears to provide acceptable results. This basic design was utilized in a very popular 800-watt professional amplifier, incorporating five paralleled output pairs in its OPS design (not shown in the illustration for the sake of clarity).

Another common variant of Figure 8.10 is illustrated in Figure 8.12. Figure 8.12 is pretty much identical to Figure 8.10 with the exception that two rail resistors have been added (resistors R1 and R7).

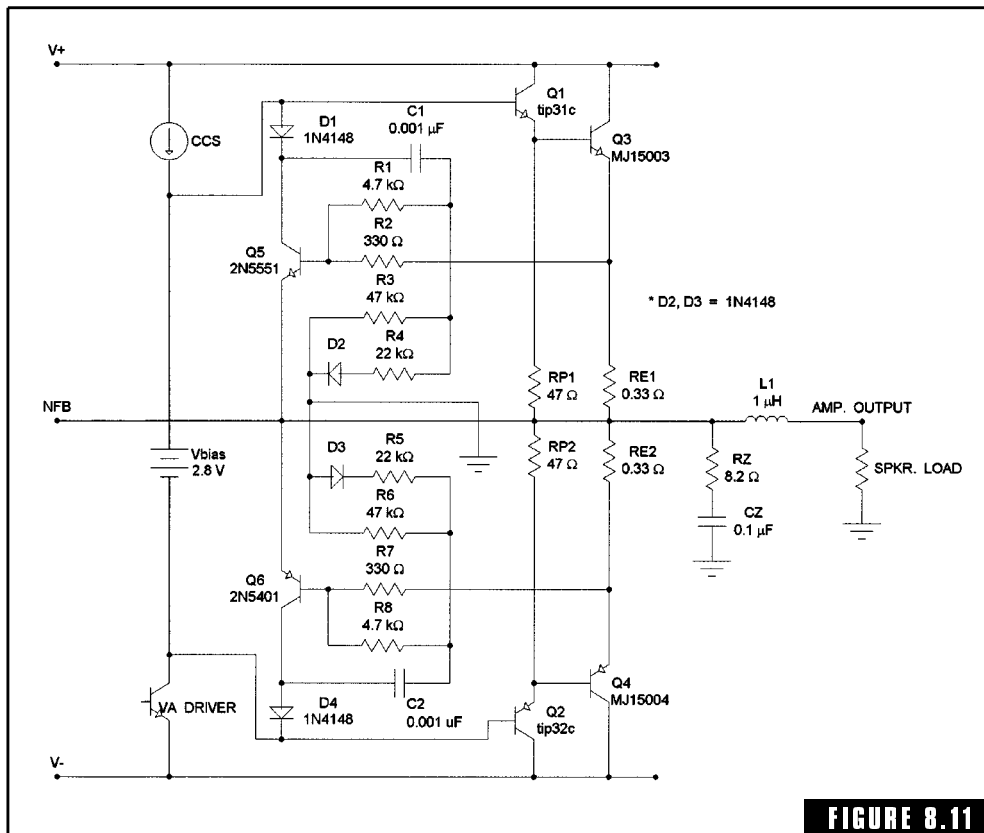
FIGURE 8.11

Commercial variation of a multislope V-I limiter.

The obvious intent here is to provide a power supply reference for the basic multislope V-I limiter. In reality, it functions almost identically to a single-slope protection circuit, so I see little point in going to the additional complexity.

Radical Methods of OPS Protection

There are a variety of nonconventional methods of providing OPS overload protection of past and present amplifier designs. One large German manufacturer places a low-value resistor in series with the speaker load. As current increases through the speaker, it increases proportionally through the series speaker resistor. The voltage across this sense resistor is compared to a preset current limit by means of several operational amplifiers. An overload condition triggers an electronic latch, forcing the user to clear the problem and momentarily turn off the power before the amplifier can be used again. This system has the potential of being a very good protection method, but the manufacturer chose to only monitor the positive half-cycles of the signal

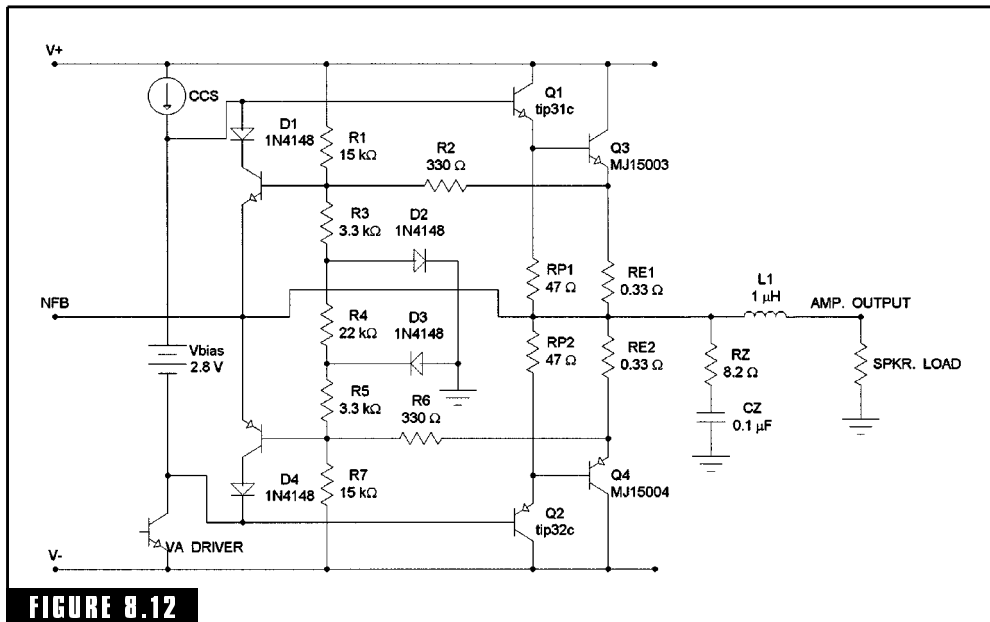
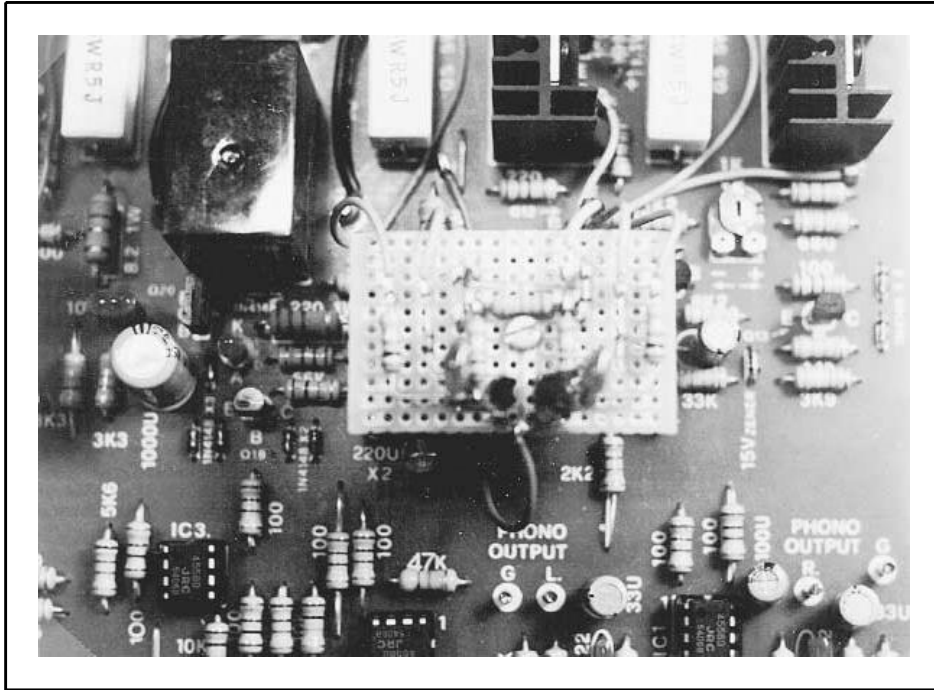

FIGURE 8.12

OPS incorporating multislope variant with reference to power supply rails.



This photo illustrates how a multislope OPS protection circuit was incorporated into a commercial amplifier without any OPS protection. The small perfbord is physically mounted to the main PC board with a single standoff.

waveform. Therefore, the negative half-cycles are without any protection at all. Output transistors can easily be destroyed in a half-cycle of improper loading at audio frequencies.

Due to the low cost and easy availability of modern microprocessor-based control systems, a few larger amplifier manufacturers have begun to incorporate digital signal processing techniques in conjunction with microprocessor-based protection systems. The motivation for this method is further improvements in the size-cost-power ratios of commercial amplifiers. There is no question that such a system can provide the ultimate in protection and reliability, but many audiophiles consider it to be a matter of overkill. They point out that there are classic models of well-designed and reliable audio amplifiers of 20 years ago that are still in use today, making the need for such extremes questionable.

MOSFET OPS Protection Methods

Lateral MOSFETs have decided advantages over BJTs when it comes to OPS protection schemes. They survive all kinds of abuse without multiloop load-line limiters or any other type of special considerations. The reasons for this are as follows:

1. The integral protection diodes quickly hard-clamp the gate drive when the junction temperature exceeds maximum ratings (providing the gate drive current is not excessively high).
2. The maximum junction temperatures for lateral MOSFETs are considerably higher than for BJTs.
3. The maximum current flow through a lateral MOSFET is self-limiting, due to increased channel resistance at higher temperatures.
4. Lateral MOSFETs are immune to secondary breakdown.

As a consequence of all of these characteristic advantages, the required electronic overload protection circuits for MOSFET OPSs are reduced to a few passive components. Basically, the whole process boils down to simply limiting the maximum gate voltage.

Figure 8.13 illustrates two methods for providing adequate overload protection to lateral MOSFET OPSs. Figure 8.13(a) shows the most common method. The maximum gate to source voltage is clamped with a zener diode, limiting the maximum source current by the maximum gate voltage. Diodes D2 and D3 are incorporated to isolate the MOSFET gates from output rail potentials. Resistors R1 and R2 limit excess VA drive current if the protection zeners begin to conduct.

In cases where the VA stage is a push-pull design (i.e., high current) with very fast slew rates, the simple zener clamp arrangement of Figure 8.13(a) may not react fast and hard enough. The circuit of Figure 8-13(b) will provide much better performance in these situations. Whenever ZD1 goes into zener conduction, Q5 will be saturated by the forward bias voltage of D2, providing gate pull-down faster than a single zener diode. Note also that the MOSFET gates will be pulled down near to the output rail potential. Thus, this protection circuit also provides a current-foldback action that is highly desirable under conditions of long-term overloads. Obviously, the same complementary action occurs with ZD4, D3, and Q6.

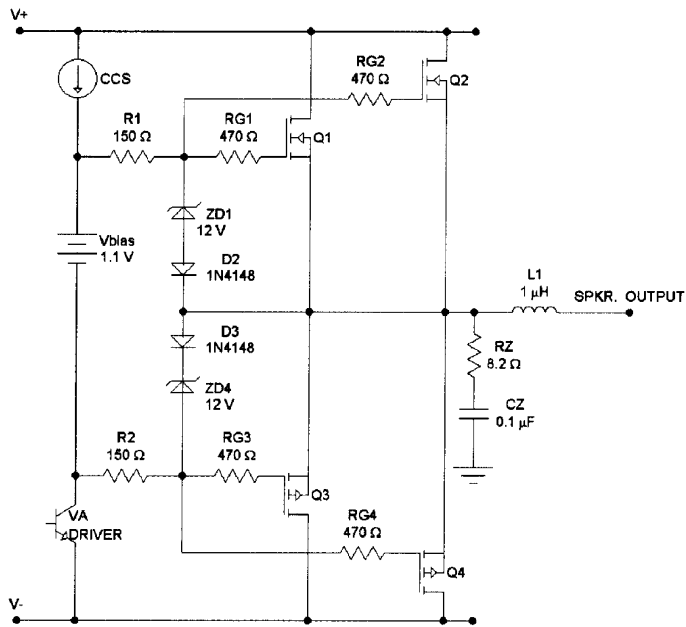

(a) Typical zener-clamped MOSFET current limit protection

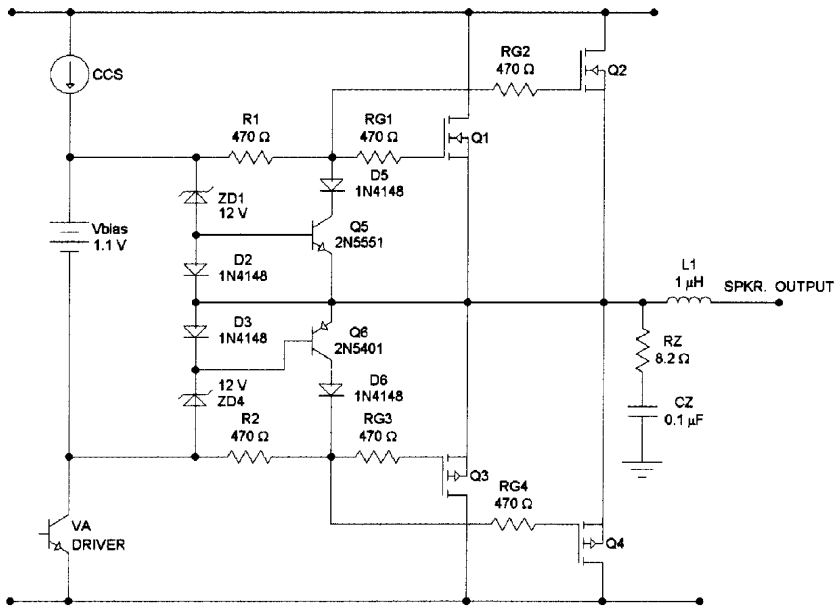

(b) Faster MOSFET clamp circuit for VA stages with high drive current and fast slew rates

FIGURE 8.13

Two examples of MOSFET OPS overcurrent protection circuits.

Both of the protection circuits of Figure 8.13 will provide adequate overload protection for the MOSFET output devices, but they suffer from one major disadvantage. The zener voltages are chosen to allow the MOSFETs to output maximum voltage and current swings for good transient response. However, the power supply rail fuses will blow if the output is short-circuited to ground, because the zener diodes provide current limitation only above the maximum current peaks. I consider any amplifier design that blows fuses under any reasonably anticipated condition to be a poor one.

My favorite overload protection circuit to use in conjunction with MOSFET OPSs is the one illustrated in Figure 8.10. This circuit effectively monitors the output load impedance and will not allow the MOSFET output devices to achieve high current levels when the output load impedance is too low or short-circuited. Under conditions of nominal output loading, it will not restrict output current at all, becoming sonically transparent. It also exhibits a current-foldback effect similar to the circuit of Figure 8.13(b), so OPS dissipation is kept to a minimum during extended periods of overload.

Note: Technically speaking, the circuit of Figure 8.10 does not actually provide a current-foldback action. Under improper output loading conditions, it doesn't allow the output current to get high enough to fold back. The end result is the same, however, in that the OPS current is kept low when overloaded.

Since the emulation of any type of SOA or reactive curve is irrelevant to MOSFET designs, the protection circuit of Figure 8.10 is very easy to modify for unique MOSFET OPS designs. The only concerns become the short-circuit output current and the minimum load at which current limiting begins to activate.

QUICK TIP

Although many will probably disagree with me on this issue, I certainly believe it is reasonable to expect to accidentally short circuit the outputs at least once in the lifetime of a typical amplifier.

I incorporated the protection circuit of Figure 8.10 in the “250 MOSFET” and “550 FET” amplifier designs of Chapter 11. Both of these amplifiers are capable of very high output power, but the outputs can be directly short-circuited to circuit common while operating at full output with hardly a spark. Not only is this action

impressive, but it is highly advantageous in high-power professional amplifiers intended for public address applications.

Designing and Implementing OPS Protection Circuits

This section will focus on the problems and methods of incorporating overload protection circuits into amplifiers utilizing BJT OPSs. As I discussed earlier, MOSFET OPSs are very easy to protect and don't present any significant design difficulties.

Although some BJT OPS overload protection circuits appear to be rather simple, in reality they are difficult to design so that the protection results will turn out as planned. There are several nonlinear and/or quasi-unpredictable variables that interact in a finished protection circuit. For example, referring back to Figure 8.7, the output impedance of the VA stage will have a very significant effect upon the actual protection locus. The collector-to-emitter impedance of the protection transistors (Q5 and Q6) will depend on the beta value of the devices and the available base current. If the OPS is being driven with a high output current VA stage, such as many push-pull VA designs, the relatively small base currents available to the protection transistors may not be enough to provide any protection at all. In other words, even though the protection transistors are forward biased, they may not have a collector-emitter impedance low enough to pull the VA drive signal down to a near output rail potential when the OPS is short-circuited. In these cases, the values of all of the associated resistors incorporated into the protection circuit may have to be decreased proportionally. It may also be necessary to place a few series resistors between the VA output and the OPS input to act as dropping resistors. It should also be remembered that the output impedance of the VA stage drops with a rise in frequency, and this comes into play when the protection circuitry is activated under high-frequency signal conditions.

Another problem involves the base impedance of the protection transistors. The nonlinear base-emitter junctions make it difficult to predict the precise value of the node voltages of the voltage divider protection networks. Continuing to refer to Figure 8.7, note how resistors R5, R3, and R1 are all summed at the base lead of transistor Q5. As the voltage at this node approaches the nonlinear conduction region of Q5 (typically between 0.65 and 0.75 volt), the impedance characteristics will vary dramatically.

The stability of the protection circuitry is another concern, especially in the high-frequency range. Protection circuitry instability is typically the result of the global NFB loop trying to correct the output level at the same time as the protection circuitry is trying to reduce it (i.e., the global NFB sees overload limiting as a form of distortion). Fortunately, this instability is almost always benign, with the protection circuitry providing sufficient OPS control to limit the destructive potential of the instability—but there are exceptions! In some cases, installing two small-value collector-base capacitors (for example, C1 and C2 in Figure 8.10) can effectively reduce high-frequency instability. This procedure must be approached with caution, however, because capacity values too high can couple a small portion of the signal voltages to the protection transistor bases, resulting in false limiting and increased amplifier distortion.

All the previously described complications provide a real headache to anyone trying to design or customize reliable OPS overload protection. The easy solution is to simply use one of the cookbook designs provided in this chapter or in the subsequent cookbook designs of Chapter 11. All of the protection designs provided herein are applicable to the major BJT output devices specified throughout this book and should provide adequate protection utilizing dual power supply rail voltages up to 65 volts. The protection circuit of Figure 8.11 can be used reliably with up to 85-volt rails. All these designs were tested with VA output impedances of 100 ohms, so the incorporation of these designs into almost any BJT OPS should be relatively easy (in most cases, additional circuit modifications will not be required). Even if you don't intend to build any power amplifiers from scratch, these protection circuits can usually be installed into commercially manufactured amplifiers with a minimum of PC board modification. I have often constructed the protection circuit illustrated in Figure 8.10 on a very small piece of perfboard. When completed, the small circuit board was mounted with a single stand-off above the main amplifier PC board and connected to the appropriate OPS points with a few small pieces of hook-up wire. Of course, this same technique will work equally well with any of the protection designs provided here.

Additional output pairs may be paralleled to any of the OPS designs included in this chapter for increased OPS current capability.

As discussed earlier, the protection circuitry only monitors one output pair to provide protection for multiple paralleled output pairs. The protection circuitry will function equally well with CF designs as long as the same value of RE resistors is used (obviously, in CF OPS designs, RE resistors are actually in the collector legs of the output transistors).

If a situation develops in which you encounter a special application or a unique OPS design, there may be a need to custom design an OPS protection circuit. If you understand the theory and operational principles provided in this chapter, it is not too difficult to come reasonably close to an optimum design. However, overload protection circuits can be tricky because you must risk destroying the output devices to adequately test the protection performance. Considering the limited resources available to the typical hobbyist, there are several good approaches that can be taken to accomplish custom-designed projects:

1. The best method is to obtain a good software simulation program and perform all of your trial-and-error design attempts with computer modeling. I use the *Electronics Workbench, Professional Edition*, for design simulation, but there are other good simulation systems available. The concept of computer modeling has frightened many hobbyists away, but their fears are unwarranted. There is a learning curve involved with any kind computer tool, but the typical hobbyist can become reasonably comfortable with the new generation of user-friendly simulation programs in a matter of a few days. Most importantly, dozens of OPS protection designs can be thoroughly tested in a matter of hours, and you don't wind up with \$100 worth of fried transistors at your feet!

2. The second-best design approach is to begin by incorporating one of the designs included in this chapter into a functional power amplifier. Use flea clips for soldering the protection circuit components in place so they can be easily removed and exchanged as needed. Using a signal generator as a signal source and a variety of resistive dummy loads, the output waveforms can be observed under a variety of output level and loading conditions. *This step must be performed with great caution.* For initial testing, the output load should not be lower than about 1 to 2 ohms until it has been determined that the protection

circuitry is functioning. From this point, a variety of lower-resistance loads can be tested to obtain several current-limit points that can be plotted on the SOA chart for the output devices being protected. Finally, modifications to the protection circuitry can be made to adjust its action to that which is desired. The amplifier can then be retested to verify that the protection circuitry is functioning as anticipated. Even with the greatest of care, this type of experimental dynamic testing can result in a few destroyed output transistors. Keep this reality in mind, and make sure your power supplies and rail connections are properly fuse protected.

3. If you intend on experimenting with OPS protection circuits on a continual basis, a dedicated hardware simulation circuit can be constructed for this purpose. It should consist of a complete OPS design like the one used in the hybrid amplifier of Figure 7.6(a). Lateral MOSFETs are perfect for this application because they can withstand extreme short-term overloads (i.e., long enough for a fuse to blow), and they are not susceptible to secondary breakdown. If the protection circuits are going to be implemented in BJT OPS designs, the predriver transistors in the test circuit should also be BJTs. This is why a hybrid test setup is the best choice. Since the performance of the protection circuit will only apply to one output pair, only one complementary pair of MOSFETs is needed for simulation purposes. A variable DC power supply connected to the input of the simulation OPS can be used to control a variety of OPS output levels. A resistor placed in series with this power supply can simulate any value of VA output impedance desired. If the simulation circuit is constructed for permanent use, a small block of solderless breadboard can be mounted to it for quick and easy replacement of protection circuit components.

Are All V-I and Multislope Electronic Protection Systems Sonically Transparent?

The accurate and adamant answer to this question is a resounding *no*. A variety of electronic protection schemes incorporated into some commercial amplifier designs will definitely degrade sonic quality under certain loading conditions. This has led many esoterics to curtly reject all dependable overload protection circuits in favor of either no protection or dubious protection designs. Let us examine the practical truth of this matter, beginning with a discussion of the problem.

As we have already discussed, real-world speaker loading is reactive, involving the combined reactive natures of passive crossover networks in addition to the inherent reactive nature of the loudspeakers themselves. If a real-world speaker load happens to exhibit a high capacitive reactance (i.e., current leading the voltage), it is very probable that at high frequencies and high power output levels the phase difference between the amplifier's output voltage and current can reach extremes where the output current can be significantly high while the voltage is at the zero crossing point. To a typical multislope current-limit protection circuit, a significant output current at zero rail voltage looks like a short-circuited output load, and it will activate, resulting in distortion. Many esoterics simply stop at this point and condemn all electronic current-limit protection. However, there is a very important point that is often overlooked in this controversy.

Assume you have installed a multislope limiter in a BJT OPS design that is virtually ideal, following the SOA curve of the output devices precisely. If this protection circuit activates while the amplifier is powering a highly reactive load, it indicates that the output voltage-current conditions have exceeded the overload or secondary breakdown specifications of the output devices. In other words, the multislope limiter has done exactly what it was supposed to do—it kept the output devices in their SOA region at all times. If this situation caused discernible distortion, the problem is *not* in the protection circuit; it is in the OPS design or the load! Removing the OPS protection in this type of situation is like hitting your thumb with a hammer to make yourself forget about your headache. It doesn't cure the problem and only adds a secondary problem to an already bad situation.

There seems to be an ill-formed concept held by many audiophiles today that all audiophile-quality audio power amplifiers are supposed to be capable of powering any speaker load to the maximum power capability of the amplifier. This simply isn't true. Amplifier OPSs must be designed to accommodate certain limited extremes of load reactance according to the capabilities of the output devices. The principle involved here is not a matter of inconceivable ambiguities or unfathomable idiosyncrasies of audiophantasia delecti, it is a simple matter of basic physics.

Let's examine how this principle applies to a hypothetical situation. Suppose you have an exotic pair of audiophile speakers and you

want to drive them with a 100-watt audio power amplifier of your own construction. After performing an AC analysis on the speakers, the calculations reveal that at 100-watt power levels in conjunction with a particular frequency, the voltage-current phase differential could result in maximum current peaks of 4 amps while the output voltage is at the zero crossing point (this is obviously unrealistic, but it serves well for discussion purposes). You anticipate constructing an amplifier utilizing dual paralleled BJT output pairs and 50-volt power supply rails, which is typical for a 100-watt amplifier. In examining the SOA curves for the BJT devices you intend to use in the OPS, you discover the secondary breakdown region extends down to where the maximum allowable collector current at 50 volts is 1 amp. Unfortunately, things are not going to work out as you had anticipated. With a secondary breakdown specification of 1 amp at 50 volts, a minimum of four output pairs must be incorporated into the OPS design to be capable of providing 4-amp current peaks at zero output voltage.

In the previous hypothetical example, you have several options. You could decide to go ahead with your original plan of using dual output pairs in conjunction with adequate electronic overload protection. This will mean that the overload protection circuitry will not be sonically transparent under all conditions. It will activate at high volume levels and certain frequency conditions. However, you rationalize that you will seldom drive the speakers at 100-watt levels anyway, and in the few instances where some distortion might be discernible, you'll live with it. Another option would be to incorporate L-MOSFETs in place of the BJT devices. Since MOSFETs are not susceptible to secondary breakdown, you could simply modify the overload protection circuitry to accommodate the high reactance of the speaker systems (you would still need some current-limit protection to keep from blowing the rail fuses during an OPS short-circuit condition). Naturally, a third option would be to incorporate a different type of BJT output devices with higher SOA characteristics.

One of the problems involved with the controversy over electronic protection circuits is the competitive limitations placed upon commercial manufacturers. In order to maintain a competitive cost-performance edge, manufacturers do not have the luxury of incorporating as many output devices as they might like into an OPS design. Consequently, manufacturers have made sonic compromises with electronic protec-

tion circuitry in many amplifier designs. Manufacturers of professional high-power amplifiers must also anticipate many occasions wherein the user will plug and unplug speaker cables while the amplifier is operating at high power levels. If the short-circuit output current is not limited to reasonably low levels under these conditions, the speaker cable connectors can wind up welded to the amplifier's output connectors (or severely damaged from electrical arcing). Just recently, I read a construction article for a 500-watt RMS audio power amplifier wherein the designer utilized simple current-limit protection set to allow 35 amps of output current if the output happened to be short-circuited! This kind of design is not only outrageous but it is also potentially dangerous, especially when considering the fact that rail fuses and OPS fusing were totally absent.

There are viable complaints that can be made toward some cost-cutting methods of OPS overload protection. When considering high-power professional amplifiers, however, a slight sonic degradation resulting from safe and practical short-circuit limiting is certainly preferable to having cable connectors blow up in your face. In the case of domestic hi-fi, appropriate OPS design can easily render electronic overload protection circuits sonically transparent to practical loading circumstances. All of the amplifier designs in this book fall into that category.

A few types of expensive audiophile speaker systems exhibit extremely high reactive characteristics in comparison to typical high-quality speaker systems. I find it interesting that most audiophiles will point an accusing finger toward the power amplifier if it introduces discernible distortion from protection circuits when driving such atypical speaker loads. Why not criticize the speaker manufacturer for designing such an abnormal product? Why should all of the sonic responsibility be placed on the power amplifier without placing reasonable restrictions on the manufacturers of speaker systems?

One of the advantages of building your own audio power amplifiers is that you have the capability of making your own decisions in this controversy and following through with your personal attitudes. If you want to construct a 600-watt RMS amplifier so that it can drive a 1-hp capacitor-start AC motor without current-limit activation, that goal can be accomplished (in the field of industrial electronics, such amplifiers are called *variable-frequency AC motor controls*). The overload protection circuits incorporated into the MOSFET amplifiers contained in

this book can be easily modified (as detailed earlier) to provide higher output currents during zero voltage rail conditions if you anticipate driving extremely reactive speaker loads.

The only hard-and-fast rule that should never be broken in this situation is a simple one—BJT output devices should *never* be allowed to enter the secondary breakdown region under any circumstances! It is true that semiconductor manufacturers specify the tolerance of brief pulse excursions into the secondary breakdown region, but it must be remembered that we are dealing with audio frequencies. Many esoteric designs allow some compromise in this respect, and their poor reliability is a good testimony against the practice of trying to push the laws of physics too far.

Concluding Remarks on OPS Protection

To put it bluntly, any power amplifier designed so that it cannot withstand a direct short-circuit at its output terminals (without blowing a fuse) is a poor design. In addition, a good amplifier design should be capable of safely powering a wide and realistic variety of resistive-reactive loads without suffering component damage or blowing fuses. These are realistic expectations that are supported by basic common sense. Properly designed overload protection circuits used in conjunction with adequate OPS designs are sonically transparent and relatively inexpensive, with excellent overall reliability resulting from their utilization.

The individual builder can view the task of implementing OPS overload protection differently than a large manufacturer. Competitive production costs, assembly costs, and marketing concerns are typically of little importance to the hobbyist. The manufacturer must worry about squeezing every possible watt from each output device, but the hobbyist is free to add additional output pairs, providing a wider margin of safety and improved tolerance to reactive loading. Consequently, individually constructed audio power amplifiers can be much more reliable and sonically transparent than commercially available units.

Speaker Protection Methods (DC Offset Protection)

Direct-coupled audio power amplifiers pose an ominous threat to virtually any kind of speaker system. Most internal component failures

within an audio amplifier will place a considerable DC potential across the amplifier's output terminals. If a speaker system is connected to an amplifier's output terminals and erroneous DC potentials are allowed to persist for even brief periods, the voice coils of speaker system drivers may overheat and suffer permanent damage (in extreme cases, this condition can even represent a fire hazard). High-voltage DC potentials can also damage speakers by driving the speaker cones beyond their maximum mechanical excursions, but overheating of the voice coils is the more likely failure. High-quality speaker systems represent a substantial financial investment, so it becomes very prudent to provide some form of protection to disconnect the speaker and/or disable the amplifier if a significant DC potential appears at the amplifier output terminals. A significant DC voltage in this case is typically about 2 volts or higher.

Audio power amplifiers utilizing capacitors or transformers as output coupling devices are considered immune to DC offset problems (although output transformers and capacitors can develop internal shorts). However, any amplifier using such output coupling methods is automatically negated from the realm of high-quality audio, so it will be assumed throughout the remainder of this discussion that only high-quality, direct-coupled amplifiers are being considered.

Before discussing speaker protection systems that will work, it would be valuable to discuss a few methods that will not work. The entire range of amplifier output fuses and speaker protection fuses (or circuit breakers) will not provide adequate protection against all types of DC offset problems. Some fusing or circuit breaker methods will provide some protection of speaker systems in the event of a massive output device failure (i.e., when one of the power supply rails is applied directly to the speaker system), but 100 percent protection cannot be guaranteed in all cases. Some amplifier failures will create lower DC offsets at the amplifier output, such as 10 or 15 volts, and fuses or circuit breakers will not provide any protection in these cases. Such a failure condition will almost certainly destroy the speakers before any problem is recognized.

Amplifier output fusing is more of a nuisance than benefit. If the correct value of fast-blow-type fuse is found to provide some measure of protection, this fuse will always be susceptible to nuisance blowing during high levels of low-frequency musical transients. In addition, as

discussed earlier, they will also interject fuse distortion, so they are simply a bad idea from almost every perspective. Power supply rail fuses cannot provide adequate speaker protection because they suffer the same faults and limitations as amplifier output fuses.

Any type of speaker protection system depending on the function of the global NFB loop or the overload protection circuitry (such as various current foldback techniques) is an extremely bad idea. The most common type of BJT OPS failure is short-circuited output transistors. If an output transistor short-circuits from collector to emitter (the most common type of failure in BJTs), the power supply rail voltage is immediately applied to the speaker system, with the global NFB loop or any type of overload protection circuitry completely impotent. Therefore, any effective type of speaker protection system cannot depend on the internal amplifier functions. It is also preferable for it to operate from a different power supply and automatically return to a speaker-disconnected failsafe mode when operational power is not applied.

Figure 8.14 illustrates a common type of DC offset crowbar circuit. This type of speaker protection is provided in many high-power commercial and/or professional amplifiers. It boasts simple and reliable operation. If a significant DC potential appears at the amplifier output (i.e., the output of L1), capacitor C1 begins to charge through its 47-k Ω series resistor. If the offset voltage remains long enough for C1 to charge to the breakover voltage of the DIAC, the DIAC will provide a pulse to fire the TRIAC. Upon firing, the TRIAC will short-circuit the amplifier output to circuit common and blow the power supply rail fuse(s). In many designs, the DIAC is replaced with a silicon bilateral switch (SBS) for lower voltage triggering of the TRIAC (i.e., usually about 6 to 10 volts).

There are several problems associated with the type of drastic protection action provided in crowbar circuits. The concept of crowbar protection methods assumes one or more output transistors have already short-circuited, so the radical crowbar action will not cause any further component destruction. This is not always true since some types of feedback or offset problems can also cause DC offsets at the amplifier output. Theoretically, overload protection circuitry should protect the output transistors from direct OPS short-circuits, but some mediocre designs cannot cope with the abrupt action of a

**FIGURE 8.14**

Illustration of how catching diodes and a DC crowbar circuit (for speaker protection) are incorporated into a typical output stage.

fired TRIAC, so perfectly good output transistors may be destroyed by the crowbar action.

Another problem with crowbar circuits relates to the peak current capabilities of the TRIAC. If an output transistor suffers an internal collector-emitter short-circuit causing the crowbar action to activate, the TRIAC must instantaneously conduct the enormous current reserves stored in the power supply reservoir capacitors until one or more of the power supply rail fuses blow. Almost all commercial manufacturers underrate TRIACs in this regard, so crowbar action often results in the destruction of the TRIAC. Not only is the required replacement of the TRIAC an expensive nuisance, it is also common for repair personnel to fail to check the TRIAC when replacing the defective output transistor(s). If the TRIAC failed open during a previous crowbar action, the amplifier can be put back into service without replacing the defective TRIAC and all DC offset protection is lost. The end result of this risky situation is often much worse than the first problem. In sum, the crowbar circuit of Figure 8.14 will provide

adequate speaker protection (providing the circuit design is good), but it leaves much to be desired.

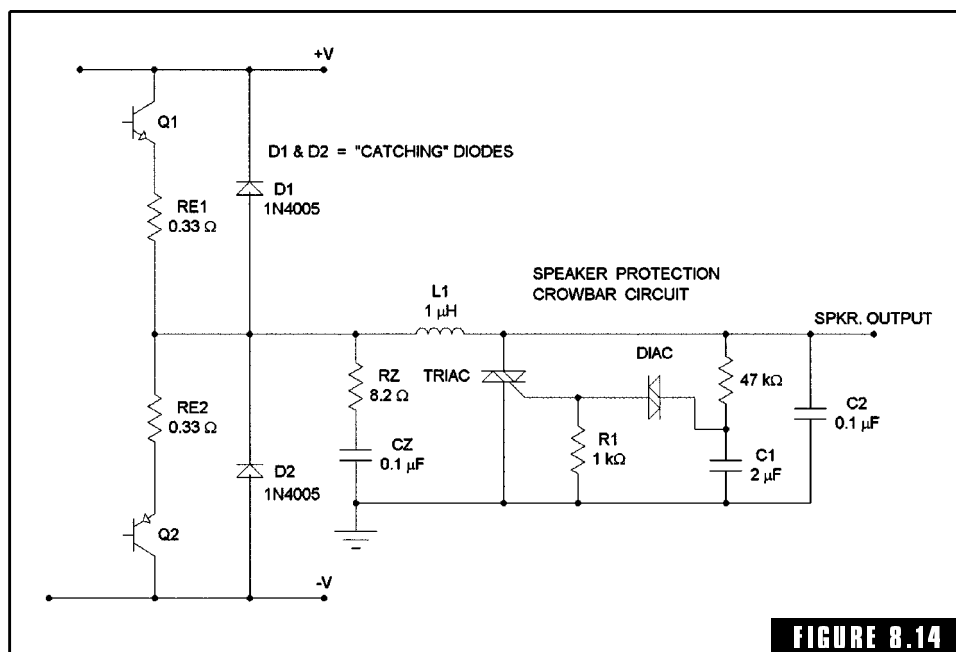
Figure 8.15 illustrates a much better and more reliable circuit for providing DC offset speaker protection. It also offers several other important actions that provide the optimum performance and protection of the entire amplifier. The circuit receives its operational power from its own power supply, receiving AC power directly from the secondary of the amplifier's power transformer. This is very desirable, because the dependence of a protection circuit on the same power supply providing operational power to the amplifier causes the protection circuit to be vulnerable to amplifier power supply problems. The power supply components are D1, C1, R1, and ZD2, making up a simple 24-volt zener regulated supply. As illustrated, the component values are correct for AC input voltages of between 27 and 35 VAC.

Note: Normally, this AC voltage is obtained from the center-tap and "one" secondary lead of a 55 to 70 V.C.T. power transformer.

The resistance value of R1 can be changed to accommodate higher or lower values of AC input voltage.

The input to the protection circuit of Figure 8.15 is connected to the output of the power amplifier. Note that the output of the amplifier is routed around the protection circuit and connected to the normally open contacts of relay CR1. When CR1 is energized, the output of the amplifier is connected directly to the speaker system through CR1's contacts. Therefore, when operational power is lost, CR1 opens, providing an open-circuit failsafe (i.e., the speaker load is disconnected in failsafe mode).

When power is first applied to the amplifier, the protection circuit will automatically be provided with operational power since it receives AC power from the same power transformer as the amplifier. R2, R3, R4, R5, LED1, C2, C3, Q1, and Q2 form a basic astable multivibrator oscillator. When power is first applied, the astable multivibrator will begin to oscillate at a frequency of about 2 Hz, flashing LED1 to provide a visual indication of its phase of operation. If there isn't any significant DC offset on the output of the amplifier, C4 will begin to charge through R7 from the 60-Hz positive pulses provided by D3 (note that D3 is connected directly to the AC input voltage). It will take

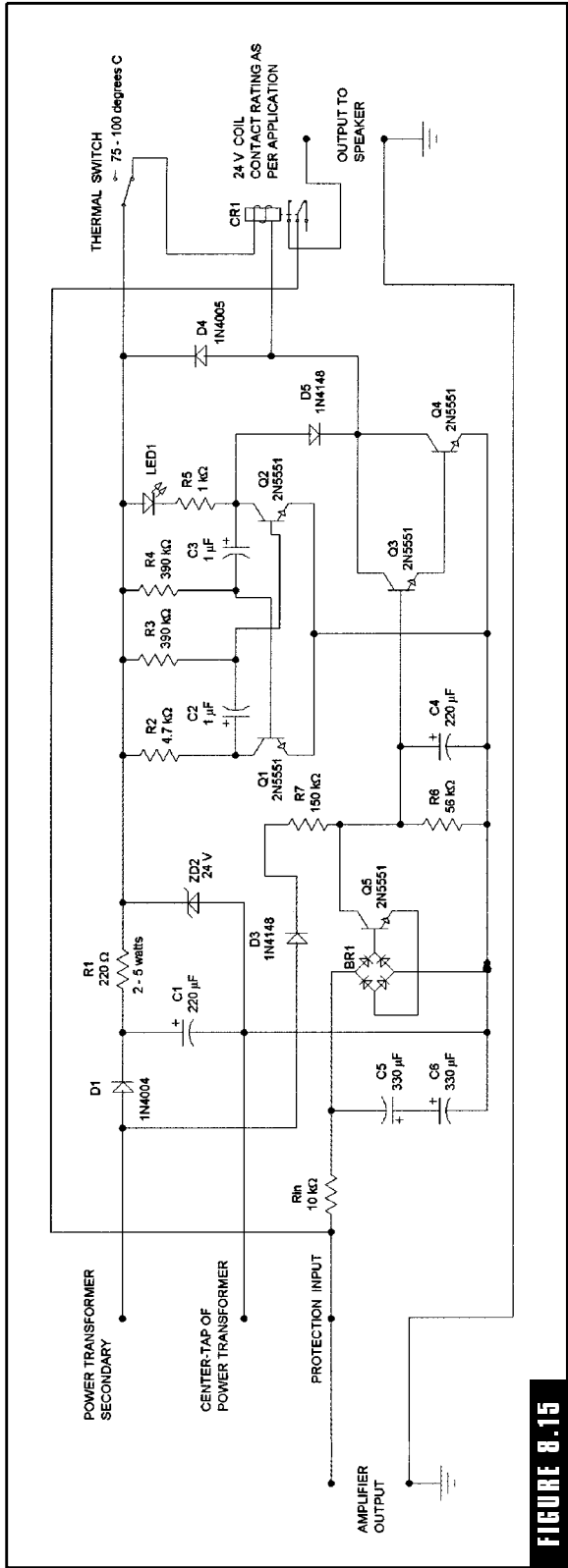

FIGURE 8.15

Automatic speaker protection and thermal shutdown circuit, providing delayed turn-on and unique four-status display.

about 2 seconds for C4 to charge to a sufficient level to saturate the Darlington pair of Q3 and Q4. When this occurs, CR1 will be energized, connecting the output of the amplifier directly to the speaker. The delayed turn-on action, referred to as *muting control*, gives the amplifier about 2 seconds to settle before being connected to the speaker. This eliminates annoying and potentially destructive turn-on transients, often called *turn-on thumps* (many direct-coupled amplifiers take as long as 100 ms to stabilize). At the same time CR1 is energized, the collector of Q2 is pulled low through D5 (and the action of the Darlington pair), inhibiting any further astable multivibrator oscillations and maintaining LED1 illuminated continuously. LED1 now provides the visual indication that the speakers are connected to the amplifier and the operation is normal.

If the amplifier DC offset becomes greater than about 1.7 volts DC, the fabricated nonpolarized capacitor C5 and C6 will charge to this level through isolating resistor Rin. Regardless of this voltage polarity, the diode bridge BR1 will rectify it (technically, steer it) so that it will saturate transistor Q5. When Q5 is turned on, its collector impedance goes low enough to discharge capacitor C4, removing the bias voltage required to keep Q3 and Q4 turned on. As a consequence, relay CR1 deenergizes and disconnects the amplifier output from the speaker load. Thus, the speaker is protected from any significant DC voltages from the amplifier output. At the same time, the astable multivibrator begins to oscillate, providing a visual indication through LED1 that the speaker is disconnected from the amplifier. If the condition clears (i.e., if the DC offset is removed from the amplifier output terminals), the protection circuit will automatically reset after a few seconds, restoring normal operation.

The thermal switch in Figure 8.15 is a normally closed version, mounted to the OPS heatsink or, preferably, to the top of one of the output devices. (Don't confuse a thermal switch with a "thermal fuse." Thermal fuses blow after one overtemperature condition and must subsequently be replaced. Thermal switches operate by means of a bimetallic strip contact and automatically reset after cooling. They are good for many thousands of operations.) If the output devices become overheated after a period of normal operation, the thermal switch will open causing relay CR1 to deenergize. This action disconnects the amplifier output from the speakers and should cause the heatsink and

output devices to begin cooling (since the amplifier is no longer under load). At the same time, the loss of CR1 as a collector load has a destabilizing effect on the Darlington pair (Q3 and Q4) and multivibrator, causing LED1 to begin flashing very rapidly (about 10 Hz). The rapid flashing of LED1 provides a visual indication that a thermal overload has occurred. When the heatsink and output devices cool sufficiently to overcome the normal temperature hysteresis of the thermal switch, the thermal switch contacts will close and reinstate normal operation of the protection circuit.

Finally, there are a few miscellaneous details about the protection circuit of Figure 8.15 that I should mention. The function of diode D4 is to suppress the inductive kickback spike that occurs when the relay coil is deenergized. The bridge rectifier BR1 can be constructed from discrete 1N4148 diodes, or a small encapsulated bridge module can be used. The maximum current capacity of the relay contacts should be chosen on the basis of their *DC current ratings*, not AC ratings. If the output devices are BJTs in TO-3 packages, the preferred method is to mount a 100°C thermal switch to the top of one of the TO-3 packages for a minimum of thermal delay. For other types of BJT packages, I use a 75°C thermal switch mounted to the OPS heatsink (this provides compensation for thermal resistance and thermal delay factors). When lateral MOSFETs are utilized for output devices, up to a 100°C thermal switch can be mounted to the heatsink, due to the much higher maximum operating temperature of MOSFETs in comparison to BJTs.

In sum, the protection circuit of Figure 8.15 provides a 2-second delay to avoid turn-on thumps, it automatically disconnects the speaker load in the event of an excessive DC offset or thermal overload condition, it provides a four-status visual indication of circuit conditions, it provides open-circuit failsafe action, and all protection actions automatically reset if the error condition is cleared. A summary of the four possible LED status indications is as follows:

LED off = power off

LED flashing slowly = 2-second turn-on delay, or DC offset protected

LED flashing rapidly = thermal overload, speaker load disconnected

LED on continuously = normal operation

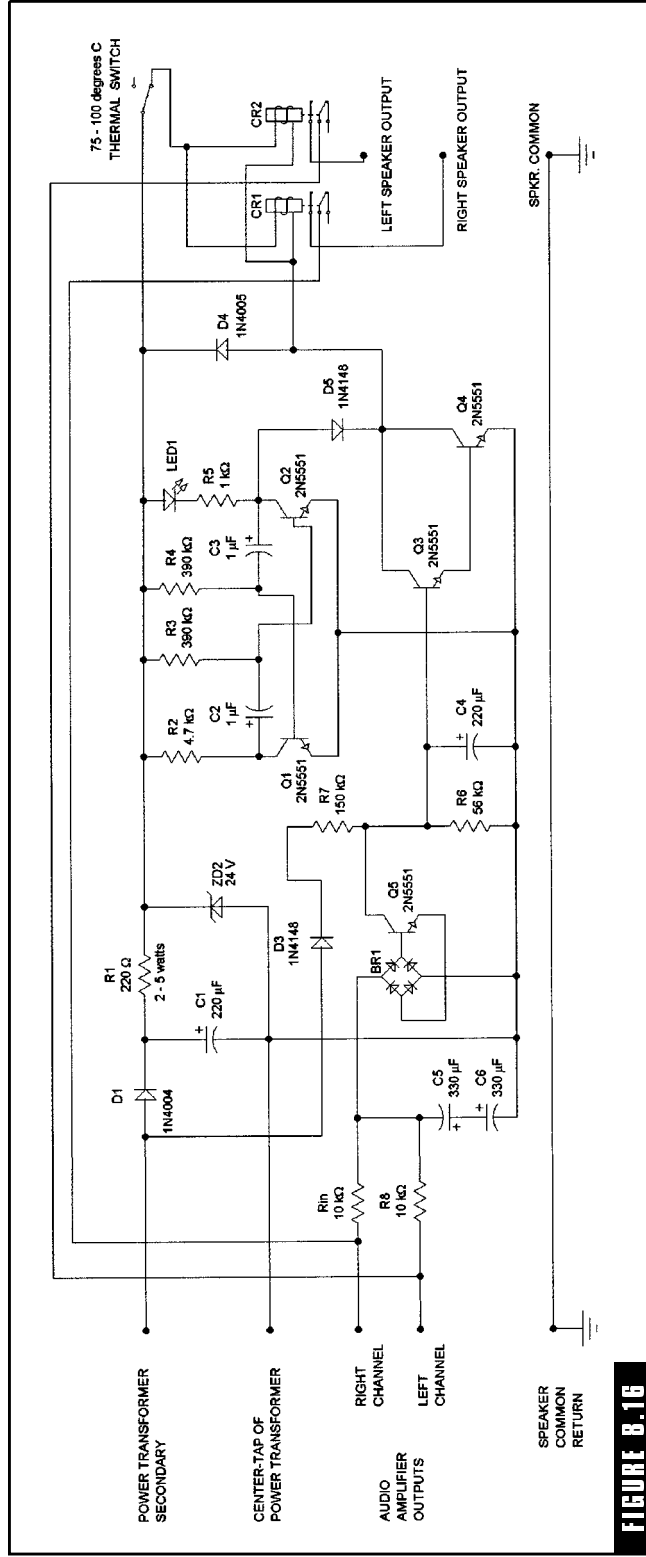

FIGURE 8.16

The protection circuit of Figure 8.15 modified for stereo applications.

Depending on the size of the power amplifier being protected, there are some considerations in using the circuit of Figure 8.15. As stated earlier, if the amplifier's power transformer provides center-tapped voltages higher than about 35 volts AC, the resistance value and power dissipation of R1 will have to be increased accordingly (I am assuming that most people reading this book will already understand the fundamentals of designing simple zener regulated power supplies). With the component values illustrated, the DC resistance of the 24 VDC relay coil (CR1) should be about 600 ohms or higher. Amplifiers with power output capabilities in the 200- to 300-watt RMS range can use a DPDT relay for CR1. The contacts should have a rating of at least 10 amps, and they should be connected in parallel (for maximum current handling capability). In the case of larger amplifiers, CR1's contact ratings should be increased up to the 25- to 30-amp range. This will probably force you to use a relay with a coil resistance significantly lower than 600 ohms, causing the relay coil to draw more current than the simple zener power supply can provide. There are numerous easy methods of modifying the power supply to increase its current capability, such as implementing a series pass transistor or going to an IC regulator of some type. Again, this is a problem of basic electronics, so I won't elaborate any further on this point. A better approach, however, will probably be to install a low-voltage transformer for dedicated use by the protection circuit(s). Since larger amplifiers will certainly utilize power transformers with much higher secondary voltages, the power losses associated with regulating down the secondary transformer voltages will probably make this approach more practical.

Figure 8.16 illustrates how the protection circuit of Figure 8.15 can be modified for use in stereo amplifier applications. Resistor R8 was added to provide an additional monitored input, allowing the input to Rin to be used to monitor the "right channel amplifier output" while the input to R8 monitors the "left channel amplifier output." An additional relay CR2 was also installed to provide the additional speaker load disconnect action. For medium-power stereo amplifier systems (up to approximately 100 watts RMS), CR1 and CR2 can be substituted with a single DPDT relay, with its dual isolated contacts providing the same speaker load disconnect action as two single-pole relays. Also, if separate heatsinks are utilized for the right and left amplifiers, an additional thermal switch can be placed in series with the one illustrated in

Figure 8.16 to accommodate thermal overload protection for both amplifier assemblies simultaneously.

The obvious disadvantage to the stereo protection circuit illustrated in Figure 8.16 is that both channels of the amplifier will be disabled whenever a DC offset or thermal overload occurs in either channel. This is of no concern in domestic hi-fi applications (in fact, it is probably more of an advantage than disadvantage), but for professional and public address applications, independent amplifier availability should always be provided. Therefore, a dual version of Figure 8.15 would be more appropriate for amplifiers designed for professional use.

The protection circuit in Figure 8.17 utilizes a slightly different method of monitoring destructive DC offsets on the amplifier's output. The basic operational principle is very similar to the previous protection circuit. Unlike the previous circuit, this protection circuit operates from the amplifier's power supply rail voltage. This is acceptable because the protection relay's failsafe is in the open condition.

When operational power is first applied to the circuit of Figure 8.17, the positive rectified voltage supplied by D2, C2, and R5 forces the base of Q2 into a slightly positive condition. Since Q2 is a PNP transistor, the positive base voltage drives it into cutoff. C3 begins to charge from the negative power supply rail through resistors R8 and R9. When C3 charges to a sufficiently high negative voltage, it turns on transistor Q3, which energizes relay CR1. The time delay while C3 is charging provides about a 1- to 2-second delay before the speaker is connected to the output of the amplifier. This action protects against turn-on thumps.

If a significant DC offset occurs at the output of the amplifier, a percentage of this offset will be dropped across the series output rail resistor RS. Bridge rectifier BR1 will steer this DC voltage so that it will saturate Q1, short-circuiting the small positive base bias of Q2 to the output rail through diode D1. With Q2's positive base bias reduced, the voltage divider of R6 and R7 will cause a negative voltage to be applied to the base of Q2 and saturate it. This action short-circuits the negative bias to the base of Q3, causing it to turn off and deenergize relay CR1. Thus, the speaker load is disconnected from the amplifier and protected from any significant DC offsets.

The primary advantage of this DC offset protection circuit is that it will also protect the amplifier and speaker load from high-frequency oscillations. Note that the output inductor L1 is included in the pro-

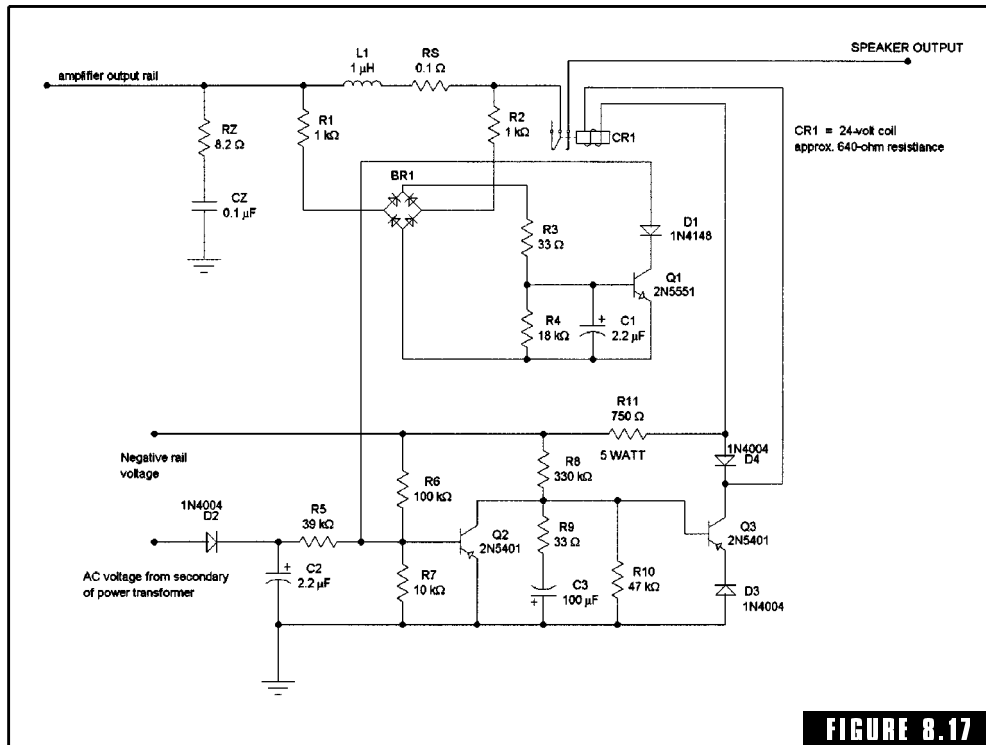

FIGURE 8.17

Automatic speaker protection and turn-on delay circuit that monitors for high-frequency oscillations.

tection circuit's sense loop. If the amplifier breaks into high-frequency oscillation (which is very destructive to the output devices and speaker tweeter systems), a large portion of the oscillation output will be dropped across L1 (L1 will not present any significant impedance to low frequencies). The high-frequency oscillations across L1 will be rectified by BR1 and applied as a positive bias to Q1. The previously described chain of events will then occur, deenergizing CR1 and disconnecting the speaker load. In most cases, when the speaker load is disconnected, the high-frequency oscillations will cease (amplifiers are typically pushed into high-frequency oscillation by the added reactance of the load). Therefore, this circuit will protect both the amplifier and speaker system from high-frequency damage until the problem can be eliminated.

The type of protection circuit illustrated in Figure 8.17 is most often applied to power amplifiers utilizing lateral MOSFET OPs

because they are much more prone to high-frequency oscillation than BJT devices. However, a well-designed MOSFET amplifier should not suffer from high-frequency oscillation tendencies, so I see little point in going to this type of protection system. A disadvantage of the circuit of Figure 8.17 is the need to place a resistor in series with the output rail. This will seriously affect the damping factor of the amplifier. In addition, R_S will dissipate a very significant amount of power, so it will decrease the overall OPS efficiency (typically, the power rating of R_S is about 10 watts).

The considerations involving the size of the power amplifier and the contact current rating of CR1 apply the same to the circuit of Figure 8.17 as previously described for the circuit of Figure 8.15. D4 suppresses the inductive kickback spikes produced whenever the coil of CR1 is deenergized. R9 limits the maximum discharge rate of C3 through Q2 when Q2 turns on and short-circuits the base of Q3. The function of D3 is to increase the required turn-on voltage of Q3 by about 0.7 volt, which helps to stabilize and lengthen the time delay. R11 drops the excess rail voltage applied to CR1's coil when energized. C1 protects Q1 from false turn-on resulting from musical transients.

Catching Diodes

A very simple and inexpensive protection option that is often overlooked is the installation of *catching diodes*. Figure 8.14 illustrates how catching diodes are incorporated into a typical OPS. Catching diodes are general-purpose diodes connected in a reverse-biased orientation from each power supply rail to the output rail. Their function is to suppress inductive back-EMF transients that can be generated from inductive speaker loads. In theory, these reverse-polarity kickback transients can be as high as two times the power supply rail potential, presenting the risk of output device failure by primary voltage breakdown. In reality, this type of failure is not common in OPSs without catching diodes, but their implementation is so easy and cheap, why take the risk?

1N4005 diodes perform well for this purpose in amplifiers of 150 watts or less. In higher-power amplifiers, catching diodes should be rated at about 3 amps with a PIV of 400 volts.

Summary

The concept that direct-coupled amplifiers are “an accident waiting to happen” is certainly true if adequate amplifier and speaker protection systems are not implemented. The task of providing reliable, universally effective protection methods that are sonically transparent is not an easy one, and it has taken a few decades to develop and field test the cream-of-the-crop circuits provided in this chapter.

To the novice wanting to incorporate protection circuits into custom-built or commercially manufactured power amplifiers, I have the following recommendations. If computer simulation testing methods are not available to you and you don't want to go to the trouble and expense of building a special test circuit, I suggest using the OPS overload protection circuit of Figure 8.10 for amplifier designs up to 200 watts RMS. I have found this circuit to be the most generally compatible with a fairly wide range of OPS designs. For very high power amplifiers (i.e., rail potentials over 60 volts), the circuit of Figure 8.11 is a good choice.

For DC offset speaker protection, I recommend the circuit of Figure 8.15. Its construction is noncritical (it can easily be constructed with perfboard and flea clips), and it provides extremely good and reliable operation.

A hypothetical audio power amplifier utilizing the protection systems of Figure 8.10, Figure 8.15, and appropriate catching diodes will be protected from OPS overload and short-circuit conditions, thermal overloads, and inductive kickback transients. In addition, the speaker loads will be protected from DC voltages and turn-on transients, and the amplifier will failsafe in a disconnected mode. The only thing missing in the overall protection scheme is protection against high-frequency oscillations, but I consider this to be a matter of good stability design.

This page intentionally left blank.

Audio Amplifier Power Supplies and Construction

The subject of audio amplifier power supplies, like most areas of audio technology, is surrounded by controversy. Throughout the short history of audio power amplifier development, there have been shifts of professional opinions, usually prompted by new developments that made older technologies obsolete. Often, older technologies will be brought back into the forefront, claiming long-lost benefits in sonic performance or reliability factors. From a historic overview, there have been three principle methods of supplying operational power to audio power amplifiers, with resurgences of popularity from time to time.

The earliest solid-state amplifier power supplies were simple unregulated (raw) DC supplies, consisting primarily of a power transformer, rectifier, and filter capacitor(s) (often called *reservoir capacitors*). Most of the early amplifier designs were either capacitor coupled or transformer coupled to the speaker load, so many of the early power

supplies were *single-ended* (i.e., they provided only one polarity of DC output voltage).

Shortly afterward, it was discovered that a linear regulated power supply could add significant improvement in the performance of many solid-state amplifier designs of that time. Hum and intermodulation distortion were the performance parameters benefiting the most from this modification.

As power amplifier designs improved, along with improvements in solid-state components, the high-power boom of the 1970s began. Linear regulated power supply designs were all but abandoned due to the additional inefficiencies involved, and the vast majority of power supply designs became the dual-polarity unregulated variety that is still, by far, the most popular type today.

Note: Single-ended power supplies cannot be used with direct-coupled amplifier designs.

During the past decade, there has been an increased popularity of linear regulated power supplies in some esoteric amplifier designs, with a few prominent audiophiles claiming significant improvements in amplifier performance. Around the same time, several amplifier manufacturers began incorporating switch-mode power supplies into their modern amplifier designs.

The advantages to switch-mode power supplies are less weight, smaller size, and less cost (provided that they are manufactured in quantity).

At present, there are strong advocates of all three power supply types (i.e., unregulated, linear regulated, and switch-mode). Obviously, before we can delve into power supply construction, we must decide on the best type of power supply to incorporate. In my opinion, the majority of the controversy in this area is unwarranted, as the facts are clear and easily interpreted.

An Evaluation of the Three Main Types of Amplifier Power Supplies

A dual-polarity unregulated raw DC power supply is very reliable and simple. In terms of cost, it is much less expensive than regulated

designs, but it can be more expensive than switching power supplies if the switching supplies are manufactured in large quantities. Unregulated power supplies provide an almost ideal environment for high-power audio amplifiers, delivering very high current peaks as needed by musical transients and wide dynamic ranges.

Unregulated power supplies have two disadvantages from the perspective of amplifier performance: the ripple content and the possibility of signal injection onto the power supply rails. Very large reservoir capacitors can reduce ripple to low values, but ultimately, ripple must be dealt with in terms of the amplifier's *power supply rejection ratio* (PSRR). Signal injection problems can be eliminated by correct implementation of the rail bypass capacitors and the simultaneous benefit of a high PSRR characteristic of the amplifier. It should also be understood that rail injection problems are equally problematic within all three of the major types of power supply design, so unregulated power supplies should not be singled out as especially difficult in this area. Both of these subjects will be discussed in greater detail a little later. From a convenience standpoint, unregulated supplies suffer from the heavy, bulky power transformer required for moderate- to high-power amplifiers, but this factor has been improved greatly of late with the easy availability of toroidal designs.

The large power transformer will be a source of abundant EMI radiation. Unshielded E + I laminated transformers are the worse culprits in this respect, with shielded E + I transformers coming in second, and toroidal transformers producing the least magnetic field leakage. The high-current bridge rectifier is also a source of RF emissions, caused by the abrupt turn-off of the high-current diodes. This condition usually worsens as current demands are increased, but can be substantially improved with the incorporation of snubbing capacitors.

The only advantage offered by linear regulated power supplies is the ability to reduce ripple content to the practical level of nonexistence. The price that must be paid for this luxury is an approximate 30 percent reduction in power supply efficiency, a much higher cost involved with the additional components and heatsinking required for the regulation devices, a decrease in overall reliability due to the additional components and circuitry, and the

Switch-mode power supplies are often called *switching power supplies* or *switching regulators*.

QUICK TIP

obvious increase in weight and bulk. Also, regulated power supplies suffer from all of the other ills previously detailed in reference to unregulated supplies. In fact, these problems are actually increased in regulated supplies because regulated supplies must be constructed on the foundation of an unregulated supply of greater capacity to compensate for the reduced efficiencies involved with effective voltage regulation.

The additional claimed benefits of regulated power supplies are mostly illusory. A modern well-designed power amplifier will probably reject ripple components as well as the active devices in a regulator circuit, so to include both in a complete power amplifier is an exercise in redundancy. While it is true that a regulated power supply will provide absolute consistency of output power levels in the face of line voltage reductions, it must be remembered that the “unregulated” portion of the power supply has to provide an output voltage about 20 to 30 percent higher, being regulated down to a lower level so that a level consistency can be maintained. An amplifier of the same size and weight without a regulator could theoretically start out with power output capabilities 20 to 30 percent higher, so a line voltage reduction of equal proportion would simply bring both amplifiers down to the same power output level. This does not turn out to be a 50-50 proposition because the amplifier with the regulated power supply will still cost more. In addition, the amplifier without the regulator circuit will be greatly superior in processing high-level transients, since it will inherently contain more headroom.

There is still another, and more serious, disadvantage with utilizing regulated power supplies in conjunction with audio power amplifiers. Regulated power supplies must incorporate some form of feedback loop to maintain regulation, and the power supply currents affected by this regulation effort are going to approximately equal the output currents of the amplifier section. Since we are already pushing amplifier components to their limits in terms of large-signal swings and slew rates, the regulator section of the power supply has only a slight advantage over the amplifier devices in terms of speed associated with large current variations. In simple terms, both the power supply regulator and power amplifier must contain a global NFB loop, with the two loops operating in concurrent fashion and each experiencing finite limitations regarding speed.

Two bad effects can develop from an amplifier loop trying to work with a power supply loop. First, as the amplifier loop is calling for a fast rise time from the OPS, the regulator loop has to be fast enough to provide the sharp current increase. At higher frequencies, the two response times become additive (i.e., the response time of the regulator must be added to the response time of the amplifier), and this can easily have a detrimental effect on slew rate performance (in fact, with high-power amplifiers, this will almost certainly be the result). Second, the global feedback loop of the regulator circuit will cause a rise in power supply output impedance with increases in frequency. While this effect can easily be negligible at audio frequencies, it must be remembered that the open-loop gain of a typical amplifier will not fall below unity until it reaches the megahertz region. The increase in high-frequency power supply output impedance automatically introduces a destabilizing effect within the amplifier. This situation amounts to a very unhappy state of stability performance for any high-performance amplifier and becomes increasingly worse as amplifier output power increases.

The controversy over the use of linear regulated power supplies in high-performance audio power amplifiers boils down to a simple, bottom-line statement—it's a bad idea! Some audiophiles may consider this last statement to be overly blunt, but I cannot honestly conceive of how any other assessment can be made.

The decision to incorporate switching power supplies in some commercial amplifiers has never been an issue of sonic performance. In fact, there are serious shortcomings involved with switch-mode power supplies that must be resolved before they can even be used with amplifier circuits. The advantages of switch-mode power supplies are weight, size, and cost. Naturally, these attributes raise dollar signs in the eyes of manufacturers, so there has been a modern competitive push toward switching power supply use within manufacturing circles. To fully appreciate the decision to utilize switch-mode power supplies in audio amplifiers, the hobbyist must try to put himself (or herself) in the shoes of the competitive manufacturer. If you examine a well-designed switching power supply, it is immediately obvious that it is much more complex than a simple raw DC power supply. The quantity and diversity of a switching power supply's electronic components is 10 to 1, or greater, in comparison to raw DC supplies. The first impression is that it must be much more expensive to develop and

construct; therefore, it must also be superior in performance. All of these assumptions are not necessarily true.

The R&D costs of switching power supplies are much higher than simple raw DC power supplies. However, R&D expenses are a one-time expenditure. Once a suitable design has been developed, it can simply be copied and manufactured for as many years as it remains competitive. In the long run, development costs can become quite insubstantial.

Manufacturers pay shockingly low prices for small electronic components when purchased in mass quantities. For example, a transistor that costs you about a dollar in your local electronics supply store will probably cost a large manufacturer about 3 cents! My first job when I got out of college was an engineering position with National Cash Register (NCR). During my first day on the job, I was amazed that the assembly line workers were instructed not to pick up any electronic components they accidentally dropped on the floor—the value of the components was not worth the labor time it took to pick them up! At the end of the day, large barrels of electronic components were swept up from the floor and sold to the Heathkit Company to resell as grab-bag specials. Heathkit paid only a few cents to the pound for these floor sweepings.

Electronic component manufacturers can afford to sell components so cheaply because they can be manufactured at very high rates with automated machinery. However, when it comes to the lowly power transformer as required for a linear power supply, there is not much that can be done to effectively reduce costs. A large power transformer requires a lot of expensive metal and personalized workmanship, making it impossible to compete with the type of cost reductions afforded by inexpensive materials and automated manufacturing processes. Consequently, manufacturers may have to pay as much for a large power transformer as they would have to pay for a thousand smaller electronic components.

This situation all boils down to the simple fact that a large manufacturer can probably manufacture a complete switch-mode power supply for about the same cost as the OEM cost of a substantial transformer. The switch-mode power supply may be more complex and contain a large quantity of components, but this all means little to a manufacturer that has set up a production line utilizing AI machinery and wave soldering processes.

Switch-mode power supplies offer some significant advantages from a marketing perspective. Marketing personnel love to be able to put fancy phrases like “digitally stabilized” or “advanced digital technology” on the front silkscreen of commercial amplifiers. The insinuation is that some new and improved technology has been incorporated into their “new-and-improved” line of amplifiers. Such terminology may mean nothing more than the use of a switching power supply (crudely defined as a digital apparatus). The term *digital* is especially meaningful in today’s marketplace because almost everyone associates digital with home computers, and the majority of consumers consider computers to be very reliable items.

It is ironic that the original motivation for going to switching power supplies has not materialized as hoped for by the early proponents. In theory, switching power supplies offered the capability of producing high-power amplifiers in much smaller enclosures, which would be advantageous from a marketing and cost perspective. Unfortunately, while some progress was made toward this goal, the attempt at significant size reduction has not been very successful. In fact, there are some manufacturing firms in the United Kingdom that are producing amplifiers utilizing conventional power supply design and class B OPSs with better power density than competitive designs incorporating switch-mode power supplies and class G OPSs! The primary size-determining factor in high-power audio amplifiers is the heatsinking and ventilation space required for dependable operation. About the only hope for small, light, high-powered audio amplifiers is a major breakthrough in class D technology, but I hold out little hope for this materializing (at least in terms of high-quality, sonically excellent performance models).

Along this same line of discussion, switch-mode power supplies do provide the advantage of lower overall weight. If you have ever tried to install a 2-kW power amplifier into a 6-foot equipment rack, you already know how important that advantage can be!

Thus far, I have been discussing switching power supplies on the basis of present concerns, but there are future considerations that are already starting to emerge in large professional amplifier systems. High-power audio amplifiers, having RMS output capabilities of 1 kW and higher, have already reached the practical limits of AC power requirements. Professional groups and entertainers may use as many

as a dozen such amplifiers when performing outside or in large auditoriums, with the combined power load resulting in a variety of AC power (mains) problems.

A new generation of smart switching power supplies are being developed by several manufacturers, providing automatic *power factor correction* (PFC) for the reduction of problems associated with the AC mains power. Switching power supplies are especially suited for the incorporation of PFC, so I expect to see more smart switch-mode power supplies incorporated into future professional audio amplifiers.

There are several disadvantages associated with switch-mode power supplies. The first and most obvious disadvantage is their reliability. They are more complex, contain more active components, and are much more likely to fail (especially from the effects of power line transients and other AC power line problems). My experience in this respect is not very favorable. In virtually every instance of switch-mode power supply failure that I have been associated with, the manufacturer has been reluctant to supply parts or information for servicing. Manufacturers recognize that switch-mode power supplies are rather temperamental, and they are additionally concerned that a user could modify the power supply so that its RFI emissions would be adversely affected. Several amplifier manufacturers have introduced switch-mode power supplies and later discontinued their use due to reliability and servicing problems. It is not my intention to insinuate that all manufacturers are experiencing severe problems with their switch-mode power supply designs, but there is no doubt that the reliability of switch-mode power supplies will always be very poor when compared to unregulated designs.

Switch-mode power supplies are notorious generators of RFI emissions because they function on the principle of high-frequency switching of the nonisolated AC power line. To put it mildly, their generation of high-frequency interference is prolific (i.e., in both directions—outgoing onto the AC line and internal to the amplifier circuitry). Many of the designs I have encountered appear to take up as much space with shielding protection as is needed for the power supply itself. Generally speaking, the problem is almost impossible to completely eradicate.

Switch-mode power supplies are likely to be slow in providing the transient current demands of the amplifier OPS. In this respect, they suffer from the same problem as linear regulated power supplies, and

this characteristic requires very close scrutiny to avoid slew distortion problems. Ripple content in switch-mode power supplies is an in-between parameter; it is improved over unregulated designs but inferior to regulated designs.

Choosing a Power Supply Type

Looking at the facts in a condensed form, the following statements can be made:

- 1.** Linear regulated power supplies are a poor choice from virtually every perspective. They are more expensive, more prone to failure, and require a larger raw DC power supply to start with. They can seriously degrade the performance of the amplifier in the areas of transient processing (i.e., headroom), slew rate, and high-frequency stability. Their only redeeming feature is the practical elimination of ripple, but this can be effectively accomplished within well-designed amplifier circuitry.

- 2.** Switch-mode power supplies offer the advantages of lower weight and reduced ripple content in comparison to unregulated designs (also, reduced cost if you happen to be a large manufacturer, or intend to buy OEM versions). In the context of very large professional amplifiers, switch-mode power supplies may incorporate PFC or other smart operational characteristics. Their disadvantages are very high levels of electromagnetic interference emissions, complexity, poor reliability, and poor transient current response (in comparison to unregulated designs).

- 3.** Unregulated raw DC power supplies have the disadvantages of the weight and cost of the power transformer, and worrisome levels of EMI radiation. In every other respect, their performance (as applicable to audio power amplifiers) is far superior to the other choices, definitely providing the opportunity for the best performance from a conventional audio power amplifier.

It may seem that every time we strive to achieve improved amplifier performance, we have to use a more complicated circuit design. I am happy to say that in the case of amplifier power supplies, the simplest is the best for the vast majority of practical audio amplifiers. I am referring, of course, to dual-polarity unregulated DC power supplies. As we delve into the design and construction of amplifier power supplies, it

will be seen how the minor problems associated with unregulated power supplies can be easily and effectively dealt with.

Power Transformer Considerations

The heart of an amplifier's power supply is the power transformer. This is also likely to be the most expensive component in the entire amplifier. It suffers the disadvantages of being heavy, bulky, and expensive, but it also probably represents the most reliable device in the entire amplifier (provided that appropriate secondary fuses are installed). Power transformers operate on a relatively simple principle of electromagnetic induction, they have no moving parts, and there is nothing internal to them that can wear out in the practical sense. I have scavenged power transformers for use in audio amplifiers that were over 50 years old, with little concern that reliability would be compromised.

The most important electrical specification of a transformer is its voltampere (VA) rating. The VA rating of a power transformer is simply the maximum specified secondary current(s) multiplied by the secondary voltage. For example, a power transformer with two secondaries, each providing 30 volts at 3 amps, would have a "load VA rating" of 180 VA ($3 \text{ amps} \times 30 \text{ volts} \times 2 \text{ secondaries} = 180 \text{ VA}$). In many cases, the primary voltage, secondary voltage(s), secondary current(s), and VA rating are the only electrical specifications provided by the transformer manufacturer. This is unfortunate because there are other important considerations.

Amplifier connoisseurs often jump to immediate conclusions regarding the quality, power, and performance of an audio power amplifier by the size of its power transformer. This is a lot like judging how fast a car can go based on the size of the engine. In reality, size is not a very good determining factor in judging the true VA rating of a transformer since a variety of manufacturing techniques can cause

a substantial difference in size and weight between two power transformers of the same ratings.

There are dissenting opinions regarding the required size of power transformers relative to given amplifier power ratings. It

**TRADE
SECRET**

**This is an area where
the hobbyist can really**

**save a lot of money by scavenging old
equipment!**

may seem odd that something so seemingly basic could be argued about, but there are valid rationalizations involved. Music and speech information inherently contain a high *peak-to-average power ratio*. In simple language, this means that an amplifier reproducing music at maximum volume (without excessive distortion) will not output its maximum power into a speaker load. This is because music or speech information contains a wide range of instantaneous amplitude levels, corresponding to the dynamic range of the program material. For example, if you sinewave tested a hypothetical 100-watt RMS audio amplifier at maximum output, you would be delivering 100 watts RMS to a speaker load. In contrast, if you performed a maximum output test on the same amplifier using recorded music as a test signal, the lulls, voids, and low-amplitude peaks of the musical passage may cause only 60 watts (on the average) to be delivered to the speaker load.

Manufacturers often incorporate transformers in commercial amplifiers rated for about 70 percent of the power required for continuous sinewave testing. This is not as bad as it seems, especially in cases of stereo amplifiers sharing a common power supply. About the only time a stereo amplifier will be continuously sinewave tested with both channels driven is during evaluation. In all other situations, the amplifier will be processing program material or sinewave tested on only one channel at a time (i.e., after a repair). Utilizing an underrated power transformer saves money and reduces the overall weight of commercial amplifiers, with both qualities being advantageous from a marketing perspective.

The only real-world problem that I am aware of in underrated power transformers is the possibility of overheating the transformer in situations where the amplifier is excessively overdriven (creating severe distortion) or the program material happens to be highly compressed. Therefore, if transformer underrated is going to be practiced, the transformer should be equipped with an internal thermal cutout. Thermal cutouts come in two varieties. One type utilizes a thermal fuse buried in the outer winding layers as a means of meeting various safety standards. Safety standards are met, but the transformer is effectively destroyed the first time the fuse blows. For obvious reasons, I certainly do not recommend using this type of transformer. The other type of thermal cutout utilizes a bimetallic switch for this purpose (often referred to as *thermostatically protected*), which will provide

the protective shut-down action but will also reset after the transformer cools. Consequently, the transformer can be used again in the normal fashion.

I do not like to underrate transformers in the power amplifiers I construct. I have two reasons for this overindulgent attitude. First, I simply like the assurance of knowing that the power transformer will not overheat under any anticipated conditions. I am willing to sacrifice a few extra dollars and aggravate my lower back condition for this luxury. Second, the regulation factor of the transformer is improved, and this provides better performance from the amplifier due to the lower power supply droop effects.

Power transformers do have a regulation factor, but this should not be confused with any type of feedback loop or active regulation circuitry. The regulation factor of a transformer is simply the ratio of the secondary voltage loaded (to maximum specifications) versus the unloaded secondary voltage. For example, if a transformer provided a secondary voltage of 30 volts unloaded and 25 volts fully loaded, the regulation factor would be about 83 percent (25 divided by 30 = 0.833). Transformer manufacturers appear to be somewhat reluctant about providing this specification, but it becomes important when analyzing the maximum drop in DC levels of a power supply when fully loaded (referred to as *power supply droop*). Obviously, an underrated transformer is going to cause a more severe droop in power supply DC levels at maximum power levels than a fully rated transformer.

Depending on your personal applications and location, it may be prudent to obtain power transformers with versatile primaries so that completed amplifiers can be easily adapted to both European and U.S. mains supplies. In commercial applications, it is also important to remember that federal emissions regulations vary widely throughout Europe, the United Kingdom, and the United States. It is possible to be in violation of certain emissions regulations by using unshielded E + I transformers in conjunction with some enclosure designs.

Transformer EMI Problems

For optimum hum reduction performance, the EMI radiation of large power supply transformers must be dealt with. EMI from transformers produces hum through induction of unwanted currents at the power

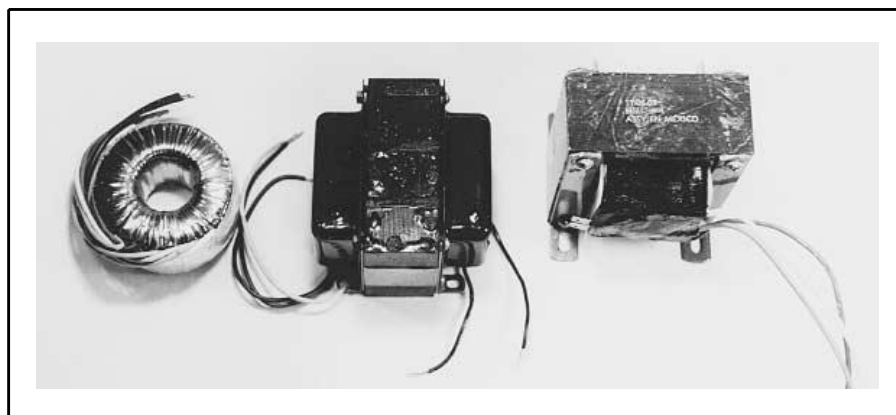

Three common types of power transformers used in power supplies for audio power amplifiers. On the right, an unshielded E+I laminated transformer. The middle is a shielded E + I type. Note the side edge of the copper belly-band on this model. The left-side transformer is a toroidal type.

line frequency. Basic electrical mathematics informs us that the induction coefficient is directly proportional to the inverse square of the distance, so the most effective means of reducing unwanted induction is space. In the physical layout of a complete amplifier, keep the power transformer as far away as possible from sensitive circuitry (i.e., high-gain, low-current, low-voltage circuitry) and signal wiring, especially signal conductors terminating into high impedances. The typical way of accomplishing optimum performance in this respect is to mount the power transformer in the rear of the amplifier enclosure, close to the incoming AC line, reservoir capacitors, power switch, line fuse, rectifier, and all other power supply components. The input and VA stage of the amplifier circuitry are mounted close to the front of the enclosure, putting as much distance as possible between them and the power transformer. In addition, input signal wires, and all other signal wiring, should be kept as far away from the power transformer as possible.

Toroidal transformer designs are the best at producing a minimum of EMI. The second-best choice is a shielded E+I laminated transformer designed for use in electronic power supplies or power amplifiers. This type of transformer is usually encased in two metallic sides, with a copper *belly-band* (or *hum strap*, as it is sometimes called) looped around the outside of the windings. An unshielded E + I laminated transformer

is the worst choice in this regard, but it can be effectively used in some situations.

Power transformers do not radiate EMI in an even pattern. It is quite possible to significantly reduce EMI problems by simply turning a power transformer in a different direction. The normal procedure for installing toroidal transformers is to leave enough primary and secondary wire length to rotate the transformer for minimum hum after it has been installed. The mounting techniques for E + I laminated transformers make this technique a little more difficult.

It is possible to ascertain a basic idea of the EMI radiating pattern of an unknown transformer with a simple test. The primary of the transformer under test is connected to an appropriate AC source. A small transformer can be used as a sensing coil by connecting its primary to an oscilloscope and physically moving it around the outside area of the transformer under test. By observing the amplitude of the induced AC voltage into the sensing coil, a rough estimate of the EMI pattern can be made. This quick little procedure can aid in determining the best mounting position of many E + I laminated power transformers.

In some esoteric amplifier designs, the entire power supply is mounted in a different enclosure, which is physically placed in a remote location from the amplifier enclosure. The rectified, filtered, and fused rail supply power is provided to the amplifier via a heavy-duty cable. This method, of course, is the ultimate technique for eliminating EMI problems, but it is an extreme measure that cannot actually be justified on a performance basis. By utilizing a good-quality transformer and following the few common-sense construction techniques just detailed, it should be rather easy to push hum levels resulting from EMI down below the noise floor.

Rectification

In modern power supply designs, it is rare to come across a bridge rectifier made from discrete diodes. The modular types of diode bridges are small, inexpensive, and provide excellent performance in every respect, so there isn't any good reason not to use them. In most medium- to high-power amplifier designs, the bridge rectifier must be heatsinked. This is typically accomplished by mounting the diode bridge module to some unused area of the amplifier enclosure.

To reduce RF emissions from the hard and rapid turn-off of rectifier diodes, it is recommended that snubbing capacitors be soldered across all four connection posts of the rectifier module, as illustrated in Figure 9.1. Snubbing capacitors are typically 0.1- μ F ceramic disc types, and they should be soldered as close to the rectifier bridge terminals as possible for the optimum effect.

RF emissions external to the amplifier enclosure are significantly reduced with the use of an X capacitor, illustrated on the primary side of the power transformer in Figure 9.1. 0.1 μ F is a typical value. Care should be exercised that the voltage rating of the X capacitor is sufficient for the maximum peak-to-peak voltage level of the AC mains supply. Considering the typical AC variations above and below nominal RMS values, a good rule of thumb is to use a capacitor with a voltage rating of about three times the nominal RMS value.

The total circuit resistance from the power transformer secondary to the reservoir capacitors should be as close to zero as possible, with the use of heavy-gauge connection wire and heavy-duty fuse holders recommended. This means the initial power-up surge currents that must be handled by the bridge rectifier will be quite substantial. Therefore, it is a good practice to generously overrate bridge rectifier modules for optimum reliability.

Power Supply Fusing

As illustrated in Figure 9.1, the line fuse and secondary fuses will be in line with the huge surge currents resulting from the initial charging of the reservoir capacitors. Therefore, these fuses should always be of the slow-blow variety.

Secondary fuses are not required for safety purposes, but they are certainly a good idea. If one of the diodes internal to the bridge rectifier happened to short-circuit, it is possible that the transformer secondary would overheat and be destroyed before the line fuse blows. Fuses and fuse holders are relatively cheap, so it is prudent to protect the most expensive component in the amplifier for this small investment.

During the initial testing phase of a newly constructed amplifier, it is wise to examine the fuses carefully during power-up. If you notice any movement or warping of the fuse element at this time, the fuse is underrated and should be replaced with the next higher value.

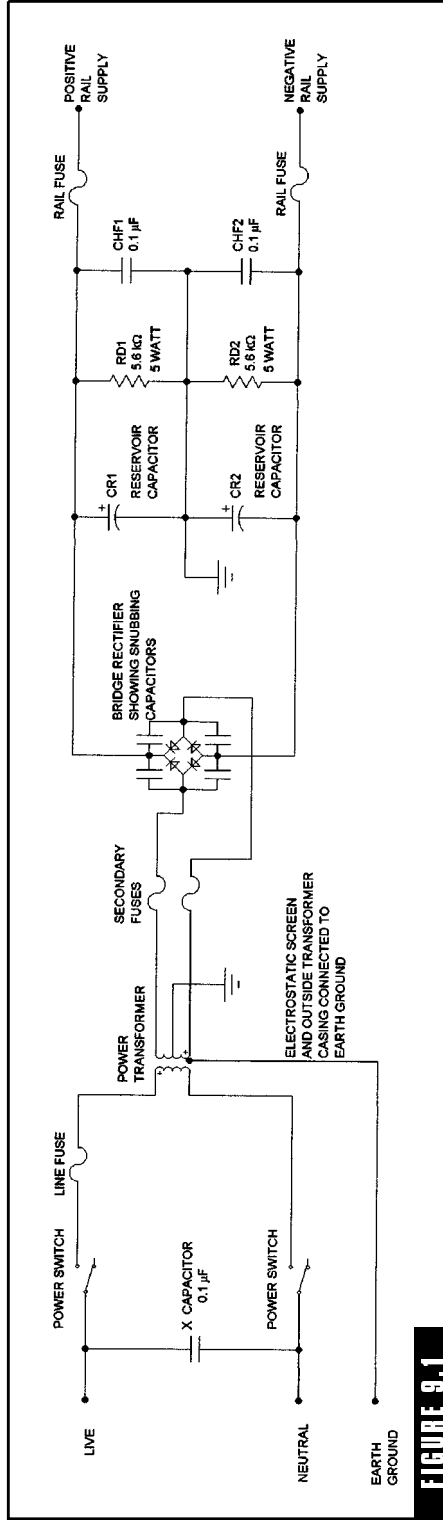

FIGURE 9.1

Wiring diagram of a typical amplifier power supply.

Reservoir Capacitors

The big controversy surrounding reservoir capacitors is the required capacity value for optimum amplifier performance. Many esoteric designs have gone to outrageous extremes in this regard, which boils down to a simple waste of money and available enclosure space. There is certainly a reasonable leeway in determining the total reservoir capacity you desire to use, but there are also a few myths floating around that have led to confusion.

There have been misunderstandings evolving from automotive sound systems involving the use of *stiffening capacitors* that have infiltrated into the other realms of professional audio. Some audiophiles have been misled to believe that large values of reservoir capacitors incorporated into line-powered audio amplifiers will provide a “firmer, stiffer bass response.” This is totally untrue. Stiffening capacitors can help low-frequency performance in automotive power amplifiers, but this is due to the limited capabilities of most DC power converters.

The reduction of ripple content is desirable to practical limits, but excessive power supply capacity is not the prudent method of reducing ripple-induced hum problems in high-quality power amplifiers. As long as ripple is reduced to reasonable levels, the amplifier’s PSRR shouldn’t have any trouble effectively eliminating it. A typical value of ripple inherent to a quality power supply under nominal loading is around 2 volts peak to peak.

As I stated back in Chapter 2, my rule of thumb for determining the size of the reservoir capacitors is to calculate 1000 μF per reservoir capacitor for every 10 watts of amplifier output power. For example, in the case of a 100-watt RMS amplifier, this comes out to about 10,000 μF of capacitance per rail supply. In truth, this method is overindulgent on my part, since 6800 μF per rail will provide excellent performance from a 100-watt RMS amplifier. A well-known commercial manufacturer of high-quality power amplifiers recommends 20,000 μF per rail for up to 225 watts RMS. Another commercial manufacturer specifies a minimum of 13,000 μF for their 300-watt RMS design, but suggests 20,000 μF per rail would be better. So, as can be seen, there is quite a bit of tolerance in this area without experiencing a significant deterioration in amplifier performance.

The best methodology for the typical hobbyist is to search through the surplus catalogs and find the best deals on capacitors with the voltage and capacity ratings such that about 1000 μF per 10 to 15 watts RMS can be achieved. Remember that capacitors can be connected in various parallel and series arrangements to provide the necessary ratings.

It is wise to overrate capacitor voltage by a least 10 percent to provide a safety margin if the line voltage happens to be higher than nominal. For example, most manufacturers utilize 63-volt capacitors for 50-VDC rails, or 75-volt capacitors for 60-VDC rails, and so on.

Miscellaneous Information about Power Supplies

Referring to Figure 9.1, resistors RD1 and RD2 are commonly called *bleeder resistors*. Their function is to safely discharge the reservoir capacitors when the operational power is turned off to the amplifier. Bleeder resistors are especially important in circumstances of amplifier failure, wherein one or both of the rail fuses blow. In these cases, the reservoir capacitors could remain charged at dangerous voltages for long periods of time. Depending on the power supply output voltages, the typical values for bleeder resistors are between 2.2 and 10 $\text{k}\Omega$, with power ratings between 2 and 10 watts each.

CHF1 and CHF2 are high-frequency decoupling capacitors. These capacitors are a last defense at eliminating any RF components that could be applied to the amplifier circuitry. RF components can originate with the bridge rectifier or be inductively coupled into the power supply through the line cord or other external RF source. CHF capacitors are not always incorporated into power supply designs, but when they are, the typical values range from about 0.01 to 0.33 μF . Voltage ratings should be in accordance to the DC output voltage of the power supply.

Power Supply Calculations

I assume the reader is familiar with the standard Ohm's law equations, so I will not go into detail regarding the calculation procedures for determining the required voltage and current outputs for specific amplifier power levels. This section will assume the reader already knows (or can easily calculate) the output specifications needed for the power supply to be constructed.

There are subtle design variations from one type (or manufacturer) of power transformers to another, making exact predictions of power supply output voltages a little difficult. To further complicate the issue, there are also slight variations in losses of bridge rectifier modules. A good rule of thumb is to multiply the AC secondary voltage of the power transformer by 1.4, and subtract about 1 volt from the answer to compensate for the bridge rectifier. For example, a power transformer with two 30-volt AC secondary windings (i.e., a 60 VCT transformer) would provide about 41 volts DC at the output of each rail of the power supply $[(30 \times 1.4) - 1 = 41 \text{ volts}]$. Exact levels of DC output voltage are not critical; a tolerance of minus 5 percent and plus 10 percent is reasonable. Power supply droop will cause the output voltage to drop on the average of 3 to 6 volts when the power supply is fully loaded. Keeping in mind that there are greater voltage losses associated with MOSFET OPSs, power supply output voltages should be souped up by about 7 percent to provide equivalent output power levels from MOSFET amplifiers.

The output current rating of the power supply is rather straightforward. It is assumed that the builder has a reasonable idea of the maximum current requirements of the power amplifier circuitry, in which case the secondary current ratings of the power transformer should be matched accordingly. If you are somewhat confused as to how to determine the required supply current for an untested power amplifier, a detailed explanation of this is provided in Chapter 10. If you intend to underrate the power transformer as in many commercial amplifiers, the maximum current rating of the power supply can be reduced to 70 percent of the maximum current demands of the power amplifier circuitry.

Rail Rejection in Power Amplifiers

The ability of a power amplifier to reject unwanted signals from the power supply rails is rather loosely defined by the term PSRR. PSRR involves two types of unwanted signal distortions: power supply ripple and signal injection on the rails. PSRR has nothing to do with induced signals from EMI radiation.

Ripple, of course, is inherent to any raw DC power supply, its component being a residual of the rectification process with a frequency of two times the AC power line frequency. Signal injection is caused by

the finite resistance of the rails themselves, creating minute voltage drops across the rail conductors. In class B amplifiers, the waveform of these voltage drops will be a half-wave reproduction of the amplified signal voltage because each power supply rail provides half of the current needed for each complete cycle.

Many of the previously discussed methods of improving the overall performance of power amplifiers provide a definite improvement of PSRR automatically. The primary game players involved for providing excellent PSRR are provided in the following list:

1. The use of constant current sources to provide tail current for the differential input stage and to act as a load for the VA stage
2. The incorporation of substantial rail decoupling capacitors physically located in close proximity to the input and VA stages
3. The utilization of a separate ground return line to the HQG point from all rail-decoupling capacitors (see Figure 9.2)
4. The use of a mirror-image topology and push-pull VA stage
5. The incorporation of decoupling capacitors across all voltage references for constant current sources or cascode stages (for example, C7 and C5 in Figure 7.6(a))

If the majority of techniques provided in the previous list have been incorporated into an amplifier design, the PSRR will be very high. Bluntly stated, the ripple and signal injection residuals on the output of the amplifier will most definitely be below the noise floor, even at high volume levels. If you have used the above techniques and still experience hum problems, they are resulting from EMI induction problems. In this case, the physical layout of your amplifier needs some further attention.

Power Supply Wiring Techniques

Wiring techniques within power supply construction are rather straightforward. There are only a few general rules to keep in mind.

As illustrated in Figure 9.2, it is very important to provide separate ground returns for the rail decoupling capacitors, the speaker load, and the input signal voltages. In my experience, this is the single most

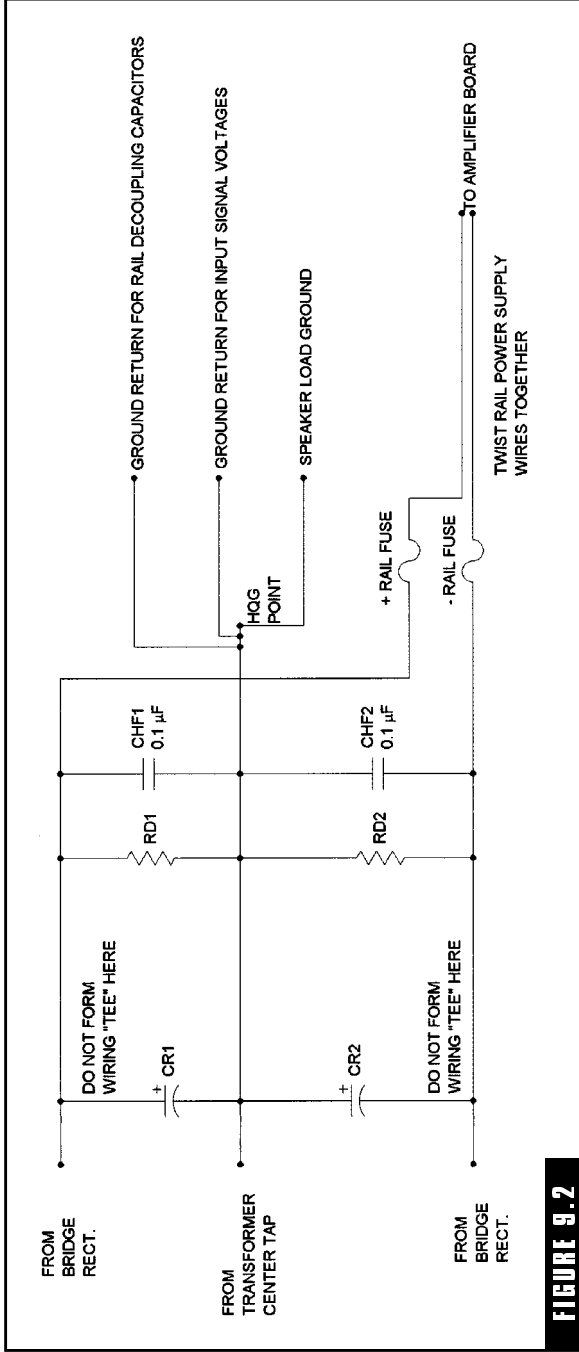

FIGURE 9.2

Illustration of good wiring techniques in power supply construction.

common fault inherent to amplifier designs, with many commercial designs totally “dropping the ball” in this respect.

Incoming AC wires should be tightly twisted together, along with the rail supply conductors. This helps to reduce interference from induced power supply ripple or AC line voltage signals. Twisting the wires together provides a self-canceling effect upon EMI fields.

A common mistake made by many audio hobbyists is forming a T network to connect the rail conductor, reservoir capacitors, and rectifier outputs together. In other words, a splice is made in the conductor connecting the bridge rectifier output and rail conductor together. Then a single conductor is run from this connection point to the reservoir capacitor. This is wrong! A T connection here will cause a significant voltage drop to occur across the single wire leading to the capacitor and the two connection points on either end. This voltage drop will look like an increase of ripple content on the rail supplies, and it can be surprisingly high due to the high charge currents running through it. The correct way to interconnect the reservoir capacitors is to run a wire from the rectifier directly to the capacitor terminal. Then connect the rail supply wire directly to this same point, right at the capacitor terminal.

Finally, all of the interconnection wire used throughout the power supply should be very heavy gauge, at least 18 AWG or considerably heavier depending on the power capabilities of the amplifier. The heavier the connection wire, the fewer wire losses will be involved! If you intend to use solderless connection lugs, it's worth the expense to purchase a professional model crimper for optimum conductivity at joint connections. Many types of cheap crimpers do a very sloppy job of applying adequate pressure to the crimp joints.

Crosstalk and DC Power Supplies

It is a common myth that individual power supplies will reduce crosstalk between stereo channels to a perceptible degree. This is certainly possible, but if there is perceptible crosstalk in a stereo amplifier sharing the same power supply, it is likely resulting from other errors that could be eliminated without going to the additional expense of dual supplies.

Crosstalk can occur in a stereo amplifier from two basic mechanisms: signal injection on the power supply rails and signal induction

from signal wires connected too close to each other. If the amplifier design is so poor that it is audibly picking up adjacent signals through the power supply rails, it is also suffering from severe problems with hum (from power supply ripple) and signal injection distortion from its own creation. In other words, you might as well scrap the design and start over again—an additional power supply is not the answer!

In virtually all cases of crosstalk problems in well-designed amplifiers, the problem is resulting from induction originating in high-current speaker output wires coming in close contact with input signal wiring. Consequently, crosstalk can be eliminated by a simple rerouting of signal wires (or discovering the shield wire is broken on the right channel amplifier, etc.).

QUICK >> TIP

All signal input wiring should be shielded. Some hobbyists and esoterics choose to shield other wiring throughout the amplifier. Usually, this is not necessary, but there are some problems originating in cramped spaces that can be remedied with this technique.

This page intentionally left blank.

Building the Optimum Audio Power Amplifier

The purpose of this chapter is to culminate all of the previous chapters into a single practical construction guide. Many of the principles or reasons behind the construction methods will not be explained in this context. It is advisable to go back and review any areas of confusion in the previous chapters wherein the subject is discussed in detail.

It is not my intention to dictate the optimum amplifier for anyone's construction goals. A high-quality amplifier design is chosen for use as a walk-through example in this chapter, but less complex designs can be applied to the same design steps with identical results.

In many design and decision-making steps, there is quite a bit of room for departure from the exact methods that I choose to use. Personal goals in the areas of cost, performance, size, weight, and on-hand inventory are important factors in the individualism of each construction project. There is nothing wrong with harboring a personal affection for a specific type of topology or OPS design, and frequent experimentation is a good teacher.

Above all, enjoy this book and have fun with it! It's O.K. to disagree with me on some issues and pursue your own heartfelt insights into

building a better audio amplifier. I sincerely hope this book turns out to be a foundation for others to use as a means of surpassing the technologies it contains.

Step 1. Establishing the Construction Goal

As an example of a construction goal, I am going to arbitrarily decide on a hybrid MOSFET stereo amplifier with an output power rating of about 70 watts RMS into an 8-ohm load. We will assume cost is of no concern, with optimum performance and quality being the determining factors of all design choices.

The application for this project will be assumed to be domestic hi-fi. Therefore, we don't have to worry about mechanical construction techniques that are overly rugged.

Step 2. Designing the Power Supply

In the previous chapter, we already determined that the best overall power supply design for an audio power amplifier application is a basic dual-supply unregulated raw DC power supply.

The voltage output of the power supply must equal the peak voltage across the speaker load plus the various voltage losses involved. The power transformer will be the determining factor for the output voltage and maximum current capability of the power supply, so it should be specified first.

Ohm's law tells us that about 24 volts RMS must be dropped across a resistive 8-ohm load to dissipate 70 watts RMS $[(24 \times 24) \div 8 = 72 \text{ watts}]$. The rail voltages of the power supply have to be high enough (in amplitude) to supply the peak voltage amplitudes to produce a 24-volt RMS amplifier output level. The peak value of 24 volts RMS is approximately 33.9 volts $(1.414 \times 24 = 33.936)$. For convenience sake, we can round this number off to 34 volts. At maximum power output of the amplifier, it can be estimated that the power supply will droop by about 3 to 6 volts, so this must be added to our peak calculation also. Roughly guessing that power supply droop will be about 5 volts (i.e., average), the peak calculation is brought up to 39 volts $(34 \text{ volts} + 5 \text{ volts} = 39 \text{ volts})$. Finally, since we are using MOSFETs for output devices, we must increase this value by about 7 percent to compensate

for the additional voltage losses. This brings our “desired power supply output voltage” up to 41.73 volts, or approximately 42 volts ($39 \text{ volts} \times 1.07 = 41.73 \text{ volts}$).

Since we now know the required power supply output voltage (that is, 42 volts), we can back-calculate to determine the required power transformer secondary voltage to provide it. Working backward, we must first add the estimated 1-volt drop of the bridge rectifier, bringing the voltage up to 43 volts. The RMS value of this voltage is the approximate secondary voltage needed, which comes out to 30.4 volts ($43 \text{ volts} \times 0.707 = 30.4 \text{ volts}$). Therefore, a power transformer with dual secondaries rated at 30 volts will work out nicely.

The next step is to calculate the current rating of the power transformer. Ohm’s law tells us that an 8-ohm load dissipating 72 watts will draw approximately 3 amps of current ($24 \text{ volts RMS} \div 8 \text{ ohms} = 3 \text{ amps RMS}$). Each power supply rail will supply one-half of this current on the average, or 1.5 amps per rail supply. Since we intend to power both sides of the stereo amplifier from the single power supply, this calculation must be doubled, equaling 3 amps per rail supply. Increasing this value by the rule-of-thumb factor of 20 percent (to compensate for normal losses), the desired maximum output current of each secondary comes out to 3.6 amps ($3 \text{ amps} \times 1.2 = 3.6 \text{ amps}$). Therefore, the VA rating of the power transformer will be 216-VA ($3.6 \text{ amps} \times 30 \text{ volts} \times 2 \text{ secondaries} = 216 \text{ VA}$).

With most domestic hi-fi applications, it is wise to anticipate the probability that the amplifier will be used to drive 4-ohm loads. It is almost universally assumed that a modern power amplifier will be capable of providing good performance and substantial increases in output power by paralleling 8-ohm speaker loads or switching to speaker systems with nominal 4-ohm impedance ratings. A worst-case 4-ohm loading of both amplifiers in our hypothetical stereo amplifier will require the VA rating of the power transformer to be doubled, bringing the previously calculated value up to 432 VA. Assuming normal losses and OPS efficiencies, this will mean that each amplifier will be capable of outputting approximately 110 watts RMS into a 4-ohm speaker load.

A power transformer rated at 432 VA seems a little large to power two amplifiers outputting a combined total of about 144 watts RMS (i.e., about 72 watts per channel), but 432 VA is about par for the

course in a stereo amplifier of this size. Under 4-ohm loading conditions, the combined total output power will be around 220 watts RMS (or a little higher). Based on the maximum transformer ratings, this equates to an overall efficiency of approximately 51 percent. Most manufacturers would underrate the power transformer to a secondary current maximum of about 6 amps (equating to 360 VA). As explained in the previous chapter, this would be adequate for powering both amplifiers when amplifying music or speech information. However, both channels of the amplifier could not deliver the maximum 4-ohm power output levels if sine wave tested simultaneously.

Obviously, the chances are nil that we are going to find a transformer rated exactly at 432 VA. In looking over the information from my power transformer supplier, I find that there are only two size breaks close to the desired 432 VA—330 VA and 530 VA. Since I believe 330 VA is too small for this application, the 530-VA model appears to be the best choice. This is illustrated in Figure 10.1. (*Note:* I'm using my primary transformer supplier as an example—an almost ideal 400 VA toroidal transformer for this hypothetical application is available from Plitron Manufacturing, Inc.)

Because cost is of no concern in this hypothetical project, I naturally chose to go with a toroidal power transformer. The transformer model of my choosing (as in the case of most toroidal power transformers) contains two primary windings. If 120 VAC mains power is used, the two primaries are placed in parallel, as Figure 10.1 illustrates. If I wanted to convert the amplifier for use with 240-VAC mains supplies at some later time, the primaries can be rewired in a series configuration. Virtually all toroidal transformers are rated for use with both 50- or 60-Hz line frequencies.

Most E + I laminated transformers used in amplifier power supplies have a *center-tapped secondary*. In other words, the secondary connections will consist of three wires, one of which is the center-tap wire. In contrast, most toroidal power transformers contain two *isolated secondaries*, meaning that two secondary wires must be connected together to form the center-tap. This is illustrated in Figure 10.1. Care must be exercised to connect the correct two secondary wires together, or the phase relationship between the two secondaries will buck each other and the power supply output will be zero.

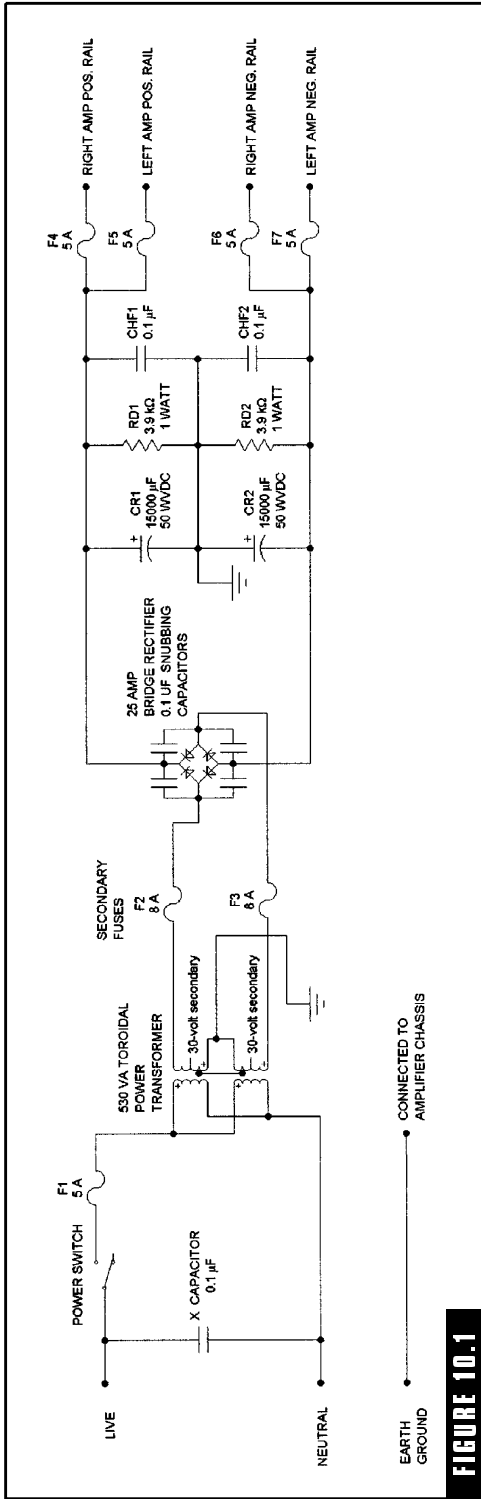

FIGURE 10.1

Power supply for 70-watt RMS stereo power amplifier.

In contrast to many E + I laminated transformers, toroidal transformers do not contain electrostatic screens or other types of shielding, so they do not have any direct connection to earth ground. In the case of shielded E+I transformers that do not provide an external wire or terminal connection for earth ground, one of the metal mounting feet should be securely connected to earth ground.

Either a 15- or 25-amp bridge rectifier can be used in the power supply design (15 and 25 amps are standard sizes). I like to go hefty with the bridge rectifier since the charge currents associated with the large-reservoir capacitors and heavy gauge wiring are quite large. A 25-amp rating in this case provides a comfortable margin of safety. The snubbing capacitors are the typical 0.1- μ F size, soldered directly to the terminals of the rectifier bridge. The capacity value of CR1 and CR2 was chosen according to the rule-of-thumb method described in the previous chapter. The total output power capability of both amplifiers should come out to about 144 watts RMS (into 8-ohm loads). At 1000 μ F per every 10 watts of output power, the capacity value of CR1 and CR2 should be about 14,400 μ F; 15,000 is a standard value. A typical commercially manufactured amplifier of this size would use about 6800 to 10,000 μ F per reservoir capacitor.

The size of F1 was determined by dividing the VA rating of the power transformer by the mains voltage. In this case, 530 VA divided by 120 VAC comes out to about 4.4 amps, so a 5-amp slow-blow fuse is a good choice. The size of F2 and F3 was determined by the maximum current capacity of the transformer secondaries. With a 530-VA rating, each secondary has a maximum current rating of 8.83 amps ($8.83 \text{ amps} \times 30 \text{ volts} \times 2 \text{ secondaries} = 529.8 \text{ VA}$). Under normal circumstances, the full 8.83 amps will not be needed, so I specified 8-amp slow-blow fuses.

Note that I specified separate rail fuses (F4, F5, F6, and F7) for each amplifier. This method is not absolutely necessary, but it provides a more rapid fuse action if a problem arises in one of the amplifiers. In power amplifiers intended for professional use, separate rail fusing is highly desirable because it provides the option of continuing to use one channel of the amplifier even if the other channel fails. I also like to use fast-blow type fuses for rail protection since the faster action can provide faster shutdown in the event of an OPS failure. In some cases, this can protect a few components from catching on fire. It is unlikely

that the speaker load currents will exceed 5 amps under any anticipated loading conditions, so I chose to specify 5-amp rail fuses in this case. For public address or musical instrument amplifiers, these rail fuses should definitely be increased to 6-amp ratings because the amplifier will have to make frequent use of the overload protection circuitry (i.e., overcurrent protection). It is unlikely that the 5-amp fuses will blow upon the first few occasions of OPS overloading, but if the OPS is continually short-circuited, the fuse elements will become weakened, resulting in poor reliability.

Finally, regarding the few miscellaneous power supply details, the standard capacity value for the X capacitor, 0.1 μF , was specified. Remember, this capacitor should be rated for at least 360 volts if used in conjunction with 120-VAC mains supplies. CHF1 and CHF2 were chosen to be 0.1 μF , which is also a common value. The resistance value of RD1 and RD2 is very unimportant, as long as its low enough to discharge the reservoir capacitors in a reasonable length of time. Naturally, you don't want to go too low in this regard or else you wind up dissipating a significant amount of power and increasing the power supply ripple; 3.9 $\text{k}\Omega$ is a good, middle-of-the-road value in this case.

As can be seen from this power supply design example, there is quite a bit of leeway in the choice of many power supply components. This is advantageous to the cost-conscious hobbyist who bargain hunts through the surplus electronic supply catalogs or happens to have accumulated a substantial scavenged inventory and would like to find uses for it. It should be remembered that modern audio power amplifiers are designed to be as immune as possible to power supply conditions, explaining the reason behind the broad acceptable power supply tolerances.

Step 3. Laying Out the Basic Topology

Since it was decided in step 1 that cost would be no object in this project, the input stage will be a mirror-image topology with a push-pull VA stage. It was also decided in the same step that the OPS would consist of a hybrid lateral MOSFET design.

At this point, we can decide on some additional specifications according to our needs and personal preferences. I have chosen to establish the input impedance at 10 $\text{k}\Omega$. Since the intended application

is domestic hi-fi, it is doubtful that this amplifier will ever be bridged, so the input impedance could be made much lower to reduce the noise specification (i.e., the reduction of Johnson noise). However, the noise should be very low anyway, and an input impedance of 10 k Ω assures that the amplifier will not excessively load almost any intended signal source.

With an application of domestic hi-fi, the chance of the OPS being shorted on a chronic basis does not exist. Therefore, it isn't really necessary to incorporate a more complex current foldback protection circuit. Also, since the output devices are lateral MOSFETs, we can forget about SOA curves and load lines. If simple current limiting is incorporated, the activation setting must be high to allow the OPS to process high-level transients without distortion. But if the activation setting is optimum for good transient processing, it will probably cause the rail fuses to blow if the OPS is short-circuited. A good option in this case is to go with a single-slope limiting circuit. With this method, we can obtain reasonably low output currents during a short-circuit condition, but high-level transient response will not be affected.

The 2SK1058 and 2SJ162 lateral MOSFETs as specified for this and other projects in this book have a maximum current rating (I_{DS}) of 7 amps with a maximum power dissipation of 100 watts. Under worst-case reactive 4-ohm loading, the OPS current peaks will approach about 6 amps, while any further current increases will automatically be limited by the overload protection circuitry (i.e., Q26, Q27, and their associated circuitry in Figure 10.2). Therefore, the output devices will remain in their SOA at all times.

Hitachi guarantees a maximum 400-watt power dissipation capability for their 2SK1058/2SJ162 devices for 10 ms, corresponding to an I_{DS} current flow of over 20 amps. In lab tests, these devices are shown to be capable of withstanding peak currents of 100 amps! This gives you an idea of how rugged these workhorses really are. Intermittent I_{DS} current peaks of 10 amps at audio frequencies are effortlessly handled by these devices, without any long-term reliability concerns.

The poorer efficiency (as compared to BJTs) of the MOSFET output devices will limit the maximum output power to about 110 watts RMS, as stated earlier. Therefore, the 100-watt-per-device rating will

be more than enough (assuming an approximate 60 percent efficiency and adequate heatsinking of the output devices). Under worst-case 4-ohm loading conditions, each output device will dissipate approximately 30 to 35 watts.

With all of the aforementioned decisions completed, a basic mirror-image topology can be laid out as illustrated in Figure 10.2. This schematic contains the component values of all of the components that are not dependent upon power supply voltages, compensation, or gain factors. In other words, these component values can be plugged into any mirror-image topology if the input impedance, OPS protection circuit, and number of paralleled output devices are known. Let's take a few minutes and walk through this schematic.

Since the input impedance was established at 10 k Ω , the value of R9 will be 10 k Ω . This automatically means that R15 must be 10 k Ω also to maintain the amplifier's DC offset balance. Because the input impedance is known, the value of the input coupling capacitor(s) can be determined. C1 and C2 form a nonpolarized coupling capacitor with a capacity value about 10 times higher than needed for a -3 -dB low-frequency response. The higher capacity was incorporated to ensure the absence of any capacitor distortion at the lowest audio input frequency. The capacity value of C3 and C4, the rail decoupling capacitors, is standard for a mirror-image input stage. (If this happened to be a single differential input stage design, the rail decoupling capacitors should be about 100 to 220 μ F.)

C6 is a good standard value for the NFB DC blocking capacitor, and C5, C7, C13, and C14 are all standard values for voltage reference bypass capacitors. These capacitors are all specified such that increasing the capacity value of any of them will provide no further performance enhancement upon the circuit.

R16 and C10 make up a high-frequency phase-advance circuit. It improves the action of the error signal generation by the differential input stages at high frequencies at which some significant phase lags are beginning to occur. Increasing or decreasing the value of either of these components will have a detrimental effect upon THD performance. Hence, you can consider these values to be standard also.

R20 and R21 are good common resistance values for stabilizing the Darlington VA drivers. Likewise, R14 and R17 are the standard resistance values used in two-pole compensation networks.

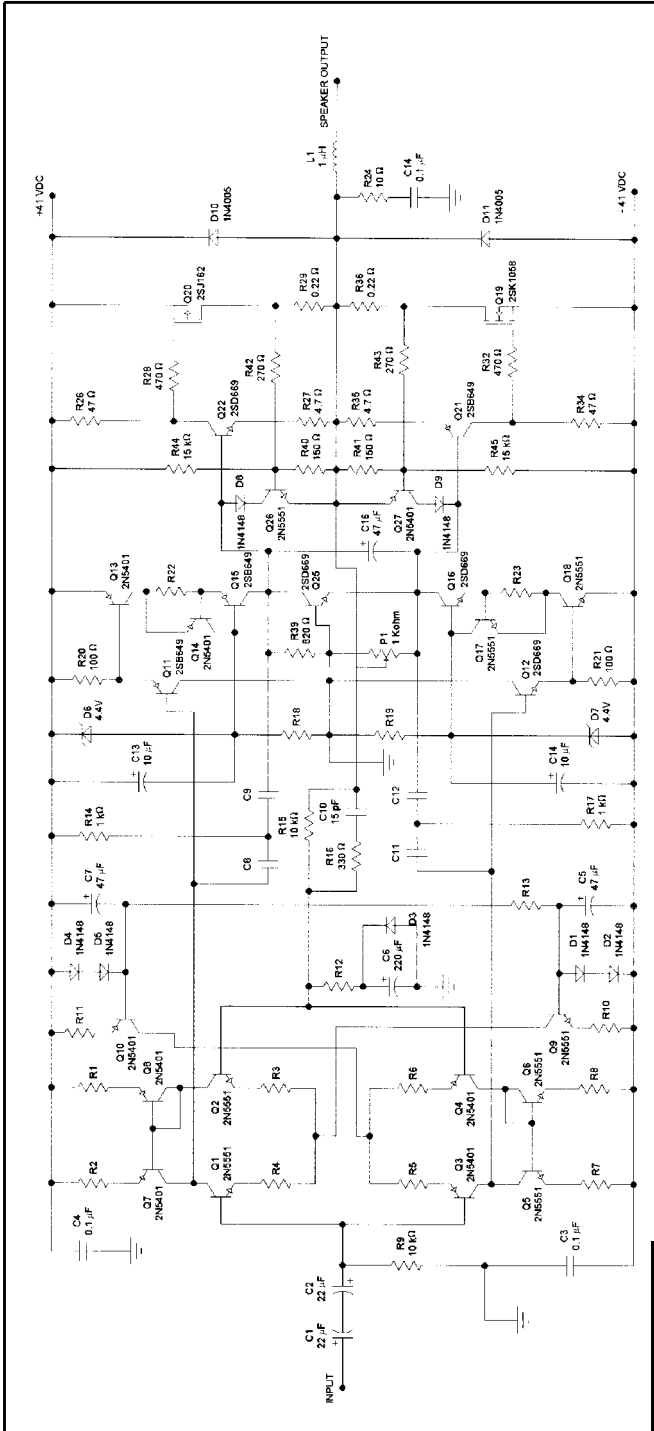

FIGURE 10.2

Established topology and known component values for a hybrid MOSFET amplifier before any calculations are performed.

R39, P1, Q25, and C16 make up the amplified diode bias circuit. These are established values that can be used in almost any type of audio amplifier design (the Qbias transistor type may vary depending on mounting considerations and OPS devices).

D8, D9, Q26, Q27, R44, R40, R41, R45, R42, and R43 comprise a single-slope OPS overload protection circuit. This circuit is almost identical to the protection circuit illustrated in Figure 8.7, with the exception that the values of R40 and R41 have been increased slightly to compensate for the lower values of R29 and R36. Current-limiting action at maximum output begins with speaker load impedances of about 2.5 ohms and lower.

The resistance values of R26 and R27 were chosen with several compromising factors involved. First, it is not desirable for Q22 to dissipate very much heat because this deteriorates the thermal accuracy and tracking capability of the bias circuit. With the values illustrated, Q22 will dissipate a little less than 2 watts under normal operating conditions. On the other hand, it is desirable for R26 and R27 to be low in resistance value to provide the best impedance interface with the relatively high gate capacitance of the MOSFET output devices. The resistance values of R26 and R27 represent a good compromise. The ratio of these two resistors sets the feedback gain of the CF OPS at 10. This also represents a good compromise between excellent high-frequency stability and a 10 to 1 improvement of linearity. All of these same factors apply to the complementary transistor Q21 and its associated resistors R34 and R35.

R28 and R32 are standard values for MOSFET gate resistors. R24 and C14 are the standard values for the Zobel network, with a standard 1- μ H inductor at the output. IN4005 diodes are commonly used for catching diodes.

The remaining semiconductor devices specified in the amplifier schematic were chosen because of their good performance, applicable specifications, and ease of availability.

Figure 10.2 represents a good basic building block for constructing audio power amplifiers. With the exception of Q21 and Q22, the remaining specified components (both active and passive) are applicable for rail voltages up to 90 volts DC and power output capabilities of over 600 watts RMS (with the incorporation of additional paralleled output stages). In the case of larger power amplifiers, Q21 and Q22

may have to be replaced with predrivers of higher power dissipation (but remember to keep the inherent capacitance low if the OPS is a CF design!).

Step 4. Determining the Application-Dependent Variables

As I stated previously, a well-designed audio power amplifier is like a large discrete-version operational amplifier. The goal of the optimum topology is to eliminate all voltage-dependent and power supply variables, causing the amplifier to function on the basis of internal ratios and the global NFB loop. The basic mirror-image topology of Figure 10.2 comes very close to the complete attainment of that goal.

The first step in calculating all of the unknown component values is to determine a value for CC (i.e., the compensation capacitor—in the case of push-pull VA designs, CC will consist of two discrete capacitors). In some cases, you may arbitrarily pick a CC value and discover that it will not fit with the succeeding component calculations. Experience has taught me that, generally speaking, small CC values work better with larger amplifiers, and vice versa. Since our application involves a power output of about 70 watts RMS with a single complementary output pair, we can classify this design as a medium-power amplifier. This means the CC value can be relatively high. For this example design situation, I'll begin with a value of 200 pF.

In Chapter 5, the equation for calculating the peak charge current of CC was discussed. It is as follows:

$$CC_{\text{IPK}} = 6.28 \times \text{frequency} \times CC \text{ (farads)} \times E_{\text{PK(VA)}}$$

Considering the output power to be 70 watts RMS and the calculation frequency to be 50 kHz (experience has taught me that 50 kHz is a good baseline frequency to use in these calculations), the answer comes out to be 2.2 mA. Multiplying this answer by 4 and then calculating 60 percent of that value, the desired tail currents for the input differential stages come out to be 5.28 mA.

Referring to Figure 10.2, the two differential tail current sources consist of Q9 and Q10, and their associated components. The resistance values of R10 and R11 establish the current setting of both constant current sources. Because we want this current to be about 5.28 mA, R10

and R11 can be 120-ohm resistors (this calculates out to 5.5 mA for each constant current source, which is close enough).

Since the value of CC was chosen to be 200 pF, C8 and C11 are specified to be 100 pF each (the total value of CC is split evenly in a push-pull VA design). Using the rule-of-thumb method of determining the capacity value of C9 and C12 (i.e., multiplying the compensation capacitor by a factor of 10), their values come out to be 1000 pF each.

Now that the tail currents for the differential input stages are known, the value of the current-mirror degeneration resistors (R1, R2, R7, and R8) can be calculated. It is desirable to have the voltage drop across the current-mirror degeneration resistors to come out to somewhere between 50 and 100 mV. As calculated earlier, the differential tail currents will be about 5.5 mA. Dividing this by 2, the quiescent current flow through each of the four current-mirror legs will be about 2.75 mA. If we start on the high side of this calculation, assuming the quiescent voltage drop to be 100 mV, the resistance value comes out to about 36 ohms [$100 \text{ mV} \div 2.75 \text{ mA} = 36.36 \text{ ohms}$]. Since we have sufficient room to go under this value, the standard value of 33 ohms seems to be a good choice (33 ohms provides a quiescent voltage drop of about 90 mV). Therefore, R1, R2, R7, and R8 can be specified at 33 ohms.

The differential tail currents and the value of the current-mirror degeneration resistors are the predominant determining factors involved in establishing the quiescent VA current (this is only applicable in push-pull VA designs—in single-ended VA designs, the constant current source used for the active load of the VA stage will determine its quiescent current value). Due to the ratios involved, it works out that the resistance value of R22 and R23 can simply be equivalent to the value of the current-mirror degeneration resistors. Therefore, in this case, R22 and R23 can be specified as 33 ohms also.

The resistance values of the differential transistor degeneration resistors (R3, R4, R5, and R6) are an experience-oriented approximation. In other words, we make our best guess. Technically speaking, we could calculate the required transconductance of the input stage, ascertain the high transconductance of the differential transistors without degeneration utilizing the appropriate transconductance curves for the devices chosen, and finally calculate the degeneration resistance needed to bring the transconductance value back down to the required value. In virtually all cases, this calculated degeneration resistance will

fall out between the value of the current-mirror degeneration resistors (33 ohms in this case) and an extreme high of around 150 ohms. In medium-power amplifiers, I normally consider a good value to be about 100 ohms. In high-power amplifier applications, I usually incorporate 47-ohm degeneration resistors. Therefore, in this case (i.e., medium power), 100 ohms would appear to be a good choice.

The resistance value of the differential transistor degeneration resistors will have subtle effects on the quiescent VA current (in push-pull designs only) and a negligible effect on THD performance, provided that it is kept within the range that I just described. Consequently, we really don't have to be overly concerned about exact values.

The resistance value of R12 will establish the closed-loop AC voltage gain of the amplifier. As calculated earlier, the RMS voltage across the speaker load must be about 24 volts to provide 72 watts of power. Since the typical sensitivity of most audio power amplifiers is about 1 volt RMS, this means we would have to have an AC voltage gain of 24 to reach the maximum output power with a 1-volt input signal. If R12 is specified at 390 ohms, the closed-loop AC voltage gain will come out to 26.6 $[(R15 + R12) \div R12 = 26.6]$. This is a good choice since it will establish the AC voltage gain a little higher than needed. However, R12's resistance value could be decreased if greater sensitivity is desired.

The resistance value of R13 is chosen to provide sufficient forward bias current to the diode voltage regulators (i.e., D1, D2, D4, and D5). Typically, the forward bias current doesn't need to be in excess of 2 to 5 mA for optimum performance. I normally neglect the small forward drop of the diodes and simply calculate the value of R13 based on the sum of the rail voltages (82 volts in this case) divided by about 5 mA. This comes out to 18.4 k Ω , so I specified an 18-k Ω resistor for R13. Caution should be exercised here that the power rating of the resistor is not inadvertently exceeded. In this case, R13 will have to dissipate about 370 mW, so a standard 1/2-watt resistor can be used. For larger power amplifiers, I often use two resistors in place of R13, with each resistor connected from the diode voltage regulators to circuit common (the same method shown for R18 and R19 in Figure 10.2).

The calculation for the resistance values of R18 and R19 is essentially the same as for R13, with a few additional considerations. First, an appropriate resistance value must be chosen so that neither the resistors nor the zener diodes will exceed their maximum power dis-

sipation ratings. Second, it should be realized that zener diodes require a higher current to remain in their zener conduction regions in comparison to the forward bias current required for standard diodes. In simple terms, this usually means that R18 and R19 are specified as low in resistance value as possible without burning up (I don't like going to 1-watt resistors if I can help it). A resistance value of 6.8 k Ω works out well in this case, providing about 5.4 mA of zener current and dissipating about 200 mW. This should be sufficient for 1/2-watt zeners, but would have to be increased if 1-watt zeners were used.

The entire amplifier design is now completed, as illustrated in Figure 10.3. During the initial testing procedures, the capacity value of C9 and C12 can be reduced for slightly improved performance (detectable only with a very good distortion analyzer), providing that there are no preliminary signs of instability brought on by the modification. As a general rule, I install all of the compensation capacitors using flea clips so that they can be easily changed if desired.

Summary

Construction and testing techniques will be discussed in depth in Chapters 12 and 13, so I won't be redundant by discussing them here. The finished amplifier, as illustrated in Figure 10.3, provides a distortion performance of approximately 0.0047 percent at 1 kHz, rising to only 0.012 percent at 20 kHz. These percentages can be improved slightly by playing with the values of the compensation capacitors.

Audio Amplifier Cookbook Designs and Discussions

A cookbook design is one in which the reader need only add the ingredients mixed with appropriate construction techniques and the amplifier will perform as indicated. If you would prefer not to take any chances with an amplifier design, the complete schematics included in this chapter provide a good selection of audio amplifier models for a variety of applications. In addition, the schematics contained in this chapter illustrate complete examples of how the many design considerations detailed in previous chapters can be implemented in a finished amplifier.

Only the amplifier schematics are contained here. External circuitry, such as power supplies, speaker protection circuits, thermal overload protection circuits, input conditioning circuits, volume controls, and external wiring are omitted for the sake of clarity.

The PC board artwork and component layout information for five of the most versatile of these designs are included in Appendix C of this book. The most readily available general-purpose heatsink types have been taken into consideration with these construction projects. If you decide to build one of these amplifiers, you can refer to the section on thermal dynamics in Chapter 12 for determining heatsink requirements.

Several of the designs contained here are definitely state of the art, representing performance levels that are significantly improved over commercial designs. However, it should be remembered that such performance levels can be obtained only if

QUICK TIP

If you happen to be a novice in this field, I recommend beginning with the amplifier design of Figure 11.1 for your first project. The PC board artwork has been especially simplified for beginners, with a sparsely populated component arrangement that makes component layout and PC board fabrication as simple as possible. It is a good starting point to gain some experience. The amplifier project of Figure 11.4 is also relatively easy if you feel a little more confident.

the remaining facets of power supply design, thermal dynamics, and good construction techniques are adhered to. I have tried to be conservative with my performance measurements while being factual with the goals that can be obtained. Unless your construction methods deviate radically from the conventional norm, I believe your results will be realistically close.

With appropriate modifications, it is possible to mix and match various stage designs to facilitate your personal concept of the ideal amplifier. I sincerely hope that all your projects turn out well and, most importantly, that you can experience the joy, satisfaction, and excellent sonics resulting from a well-planned construction goal. Exquisite sound is addictive!

Design 1. A Basic MOSFET Design

Figure 11.1 represents one of the most simple power amplifier designs possible that will still deliver reasonably good performance. It incorporates the 2SK1058/2SJ162 L-MOSFET devices, so reliability is excellent. In the event of an OPS short-circuit, the rail fuses will blow, but the L-MOSFETs can survive such current overloads due to their high transient-current parameters. This is the only

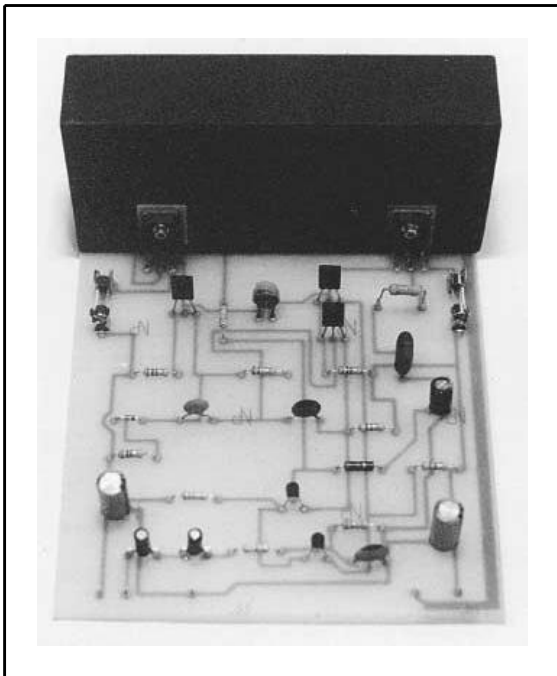

The basic MOSFET amplifier design of Figure 11.1. The PC board artwork for this model is provided in Appendix C.

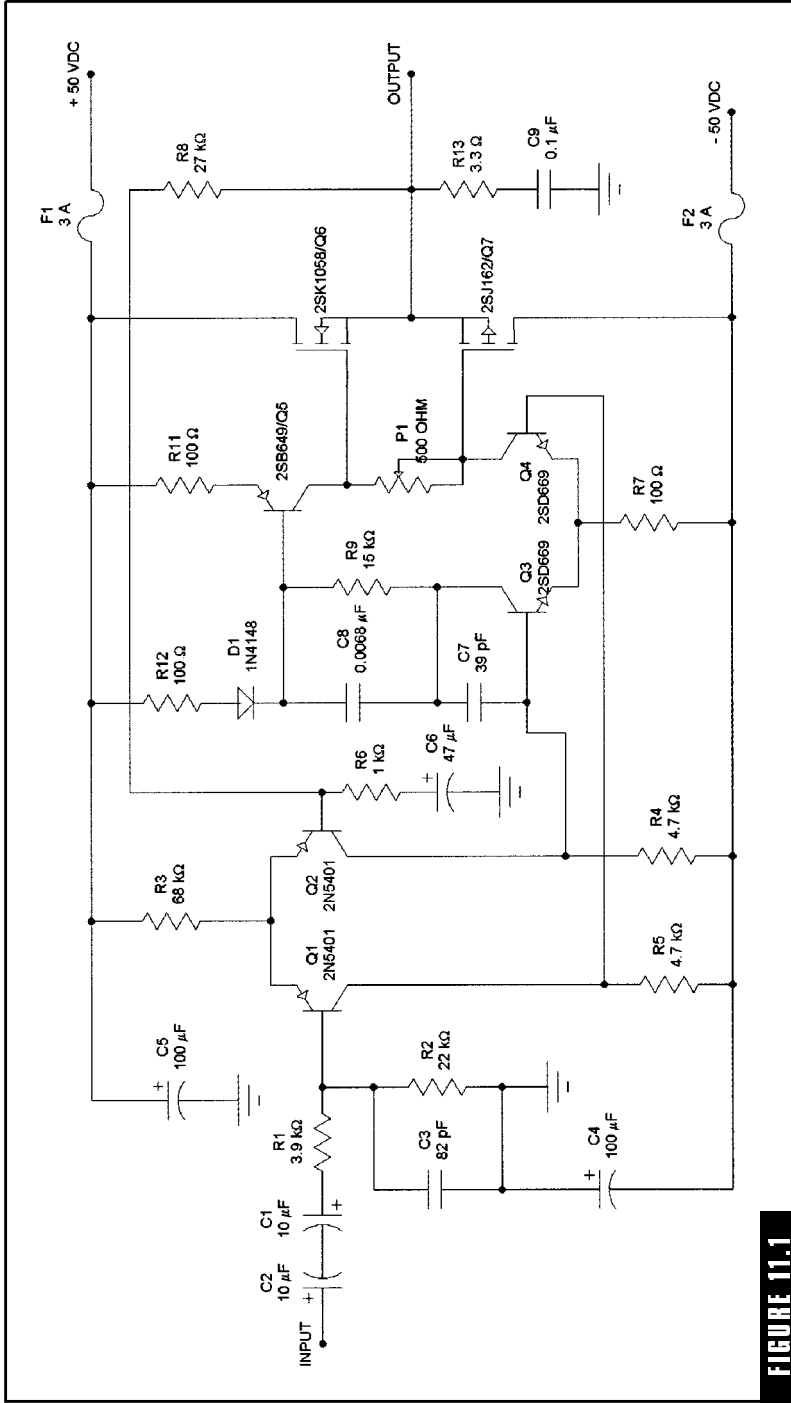

FIGURE 11.1

One of the simplest power amplifier designs possible that will provide reasonably good performance.

complete amplifier design in this book that doesn't provide some form of short-circuit protection.

The performance of this design in the low-frequency audio realm is good, with typical distortion specifications below 0.1 percent. However, at higher frequencies (i.e., above 5 kHz), distortion performance begins to deteriorate, typically reaching about 2 percent at 20 kHz.

Since OPS overload protection is not provided, this design should be incorporated only into dedicated speaker applications, such as powered subwoofer systems or budget guitar amplifiers. Surprisingly, many low-priced commercial powered subwoofer systems utilize this same basic circuit. Commercial guitar amplifiers utilizing IC audio amplifiers or encapsulated hybrid audio amplifier modules are typically higher in distortion content than this design, with significantly lower maximum output power capability. Therefore, the incorporation of this design into many low-priced guitar amplifiers will provide a decided improvement.

As can be visualized, there are practical applications for the design of Figure 11.1. In any event, it is a good beginning project to experiment with and gain some practical experience. Don't try to use this design with a speaker system until you have verified that the DC output voltage is near zero, and always incorporate rail fuses.

Design 2. A Versatile 1980s Vintage Amplifier Design

Figure 11.2 represents a 1980s concept of an optimum audio power amplifier. The fads of eighties-vintage esotericism, such as cascode input stages and differential VA stages, are apparent in this design. The only design changes I incorporated were to improve stability and PSRR; nothing has been done to modify the eighties-vintage sonics. However, this should not be misconstrued as a representation of the classic transistor sound of the seventies. For the most part, transistor sound is a colloquial definition for massive quantities of third harmonic distortion and excessive crossover distortion—in other words, a poorly designed amplifier. In contrast, Figure 11.2 is a high-quality amplifier design, exhibiting electronic enhancements associated with audio amplifier developments implemented in the 1980s. If you would like to construct a classic eighties design, this is a good choice.

From a modern practical perspective, I like to use this design for musical instrument amplifiers (i.e., guitar amplifiers, keyboard

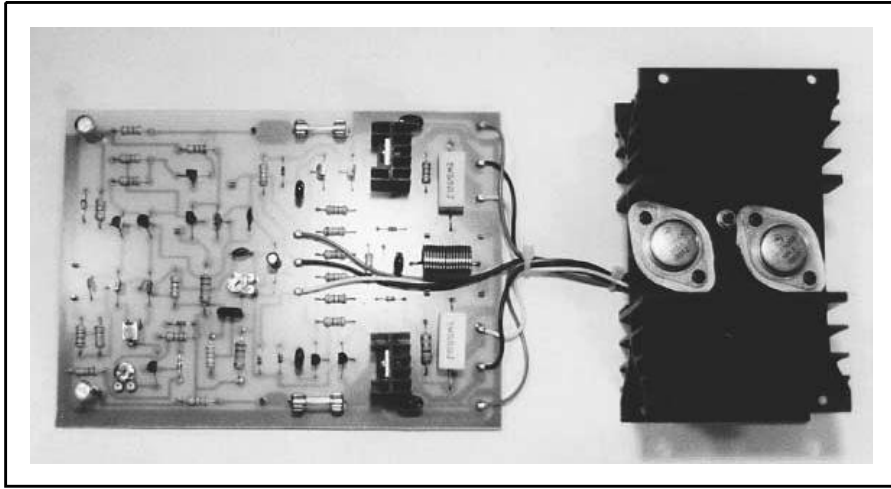

The 1980s-vintage audio amplifier design of Figure 11.2. The PC board artwork for this model is supplied in Appendix C.

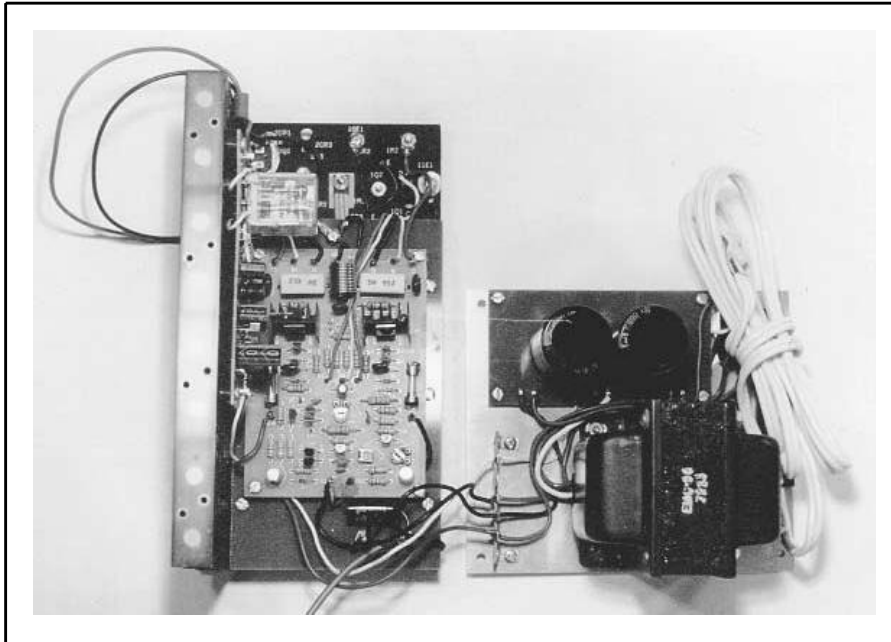

The amplifier design of Figure 11.2 mounted to an L-shaped heatsink with accompanying power supply and protection circuit of Figure 8.15. The intended application is a keyboard amplifier.

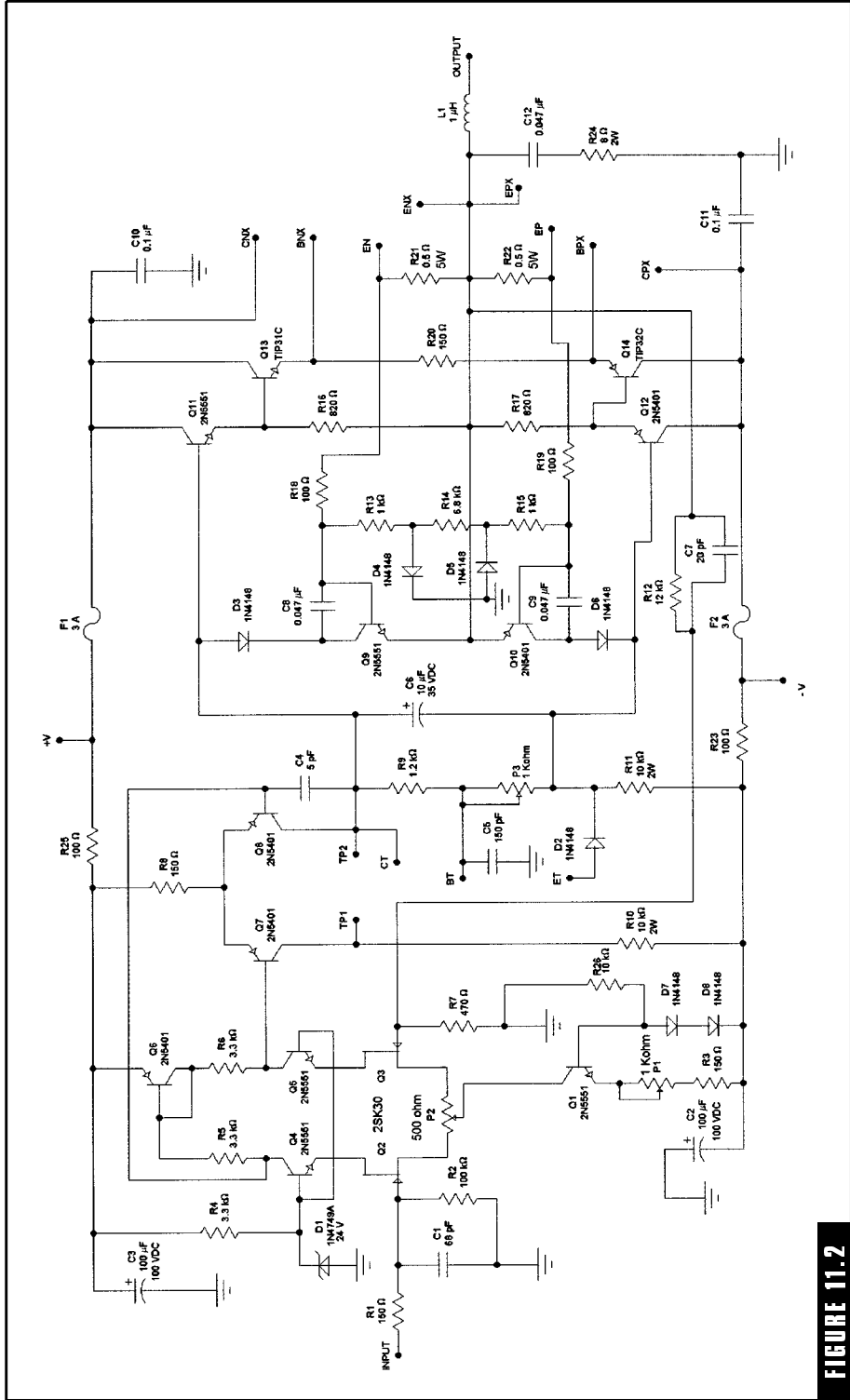

FIGURE 11.2

A common 1980s-vintage hi-fi amplifier design. This design, in particular, is highly versatile and is especially suited to musical instrument amplifiers.

amplifiers, bass amplifiers, etc.). It possesses a benign retaliation characteristic when upset with terrible injustices, such as plugging a guitar cord into the amplifier before plugging it into the guitar or keyboard. The primary reason behind this easygoing behavior is the J-FET input stage, which promises an absolute zero input offset voltage combined with relatively low transconductance. To my knowledge, this is about the only real advantage offered by differential J-FET input stages.

The design of Figure 11.2 is also a good choice for a high-quality stereo hi-fi system. If you are adamant about “direct FET coupling for CD playback” (as advertised on the front silkscreen of many commercial audio power amplifiers), this is the design to choose.

Several years ago, due to personal requirements, I converted this design into a highly versatile single PC board format. Depending on your personal goals, this could be advantageous. Figure 11.3 illustrates how the design of Figure 11.2 is utilized. For medium output power (i.e., up to approximately 80 watts RMS), only a single complementary output pair is needed, so Q2 and Q4 in Figure 11.3 are

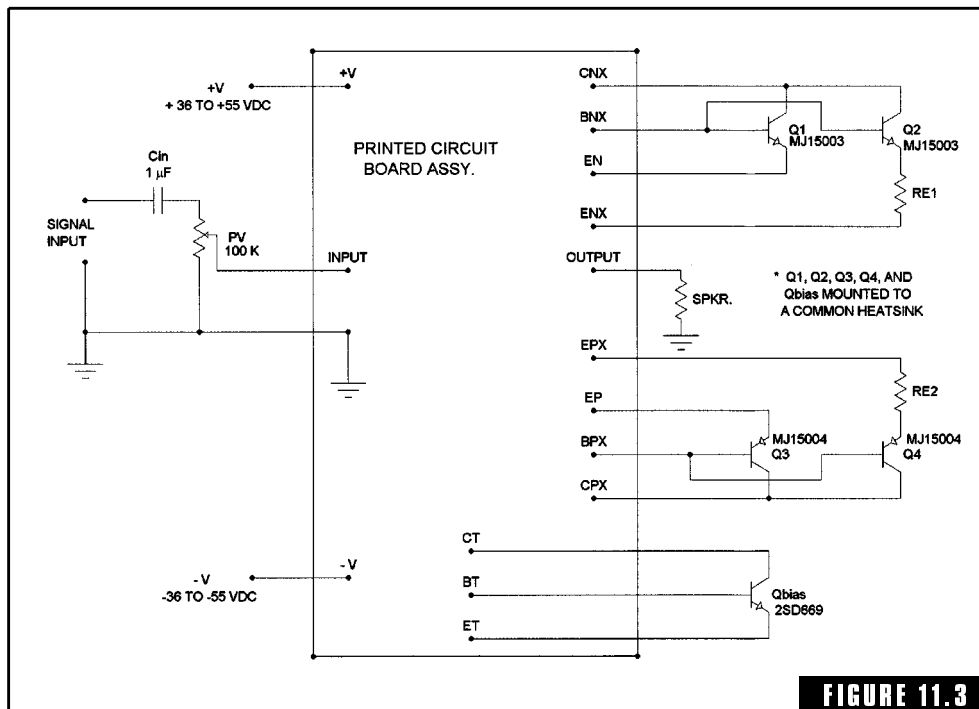

FIGURE 11.3

Connection diagram for power amplifier PC assembly illustrated in Figure 11.2.

deleted. For higher output power applications, up to three complementary output pairs can be installed, providing a maximum output capability of about 250 watts RMS. The only modifications required are extra sets of RE resistors (which must be mounted externally), higher power supply voltages, and higher-rated rail fuses. The on-board RE resistors R21 and R22 automatically take care of the current overload concerns regardless of how many parallel output stages are incorporated.

The initial setup procedure for this amplifier is a little different from most designs. Upon application of operational power, P1 is adjusted first to obtain a balanced (i.e., zero volts) condition between test points TP1 and TP2. When this is accomplished, P2 is adjusted to obtain zero DC volts at the output. Since the adjustment of P1 and P2 is interactive, the procedure must be repeated until both conditions can be obtained simultaneously. Finally, P3 is adjusted for the lowest crossover distortion performance as in the case of any other class B amplifier.

The functional aspects of the unique input and VA stage design are detailed in Chapter 5 (Figure 5.5). Typical distortion performance for this amplifier design is about 0.04 percent at maximum output power (i.e., with a single output device pair at 80 watts RMS).

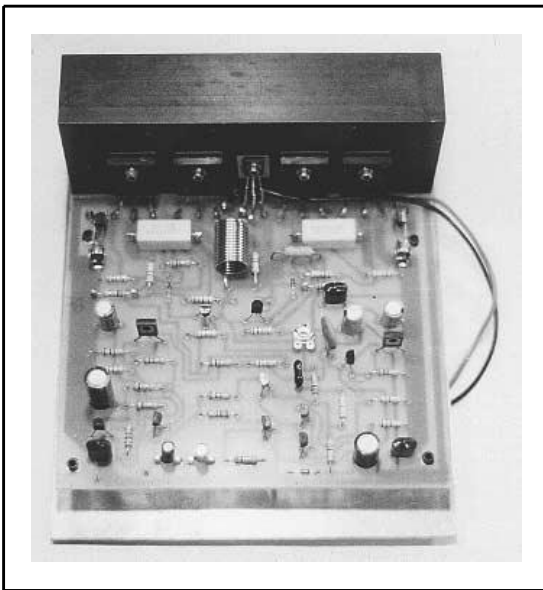

The low-distortion amplifier design of Figure 11.4. The PC board artwork for this model is provided in Appendix C.

Design 3. An Optimum Low-Distortion Medium-Power Audio Amplifier

For typical domestic hi-fi applications, it is difficult to surpass the amplifier design of Figure 11.4. It incorporates all of the best design attributes for low-distortion performance in all three stages, bringing class B performance to levels often considered impossible. All of the distortion enhancements and their associative operational principles have been discussed in previous chapters. (Note the OPS is a 100 percent local feedback CF design.)

After construction, the only adjustment required is the V_{bias} adjustment P1. When optimally adjusted, the performance

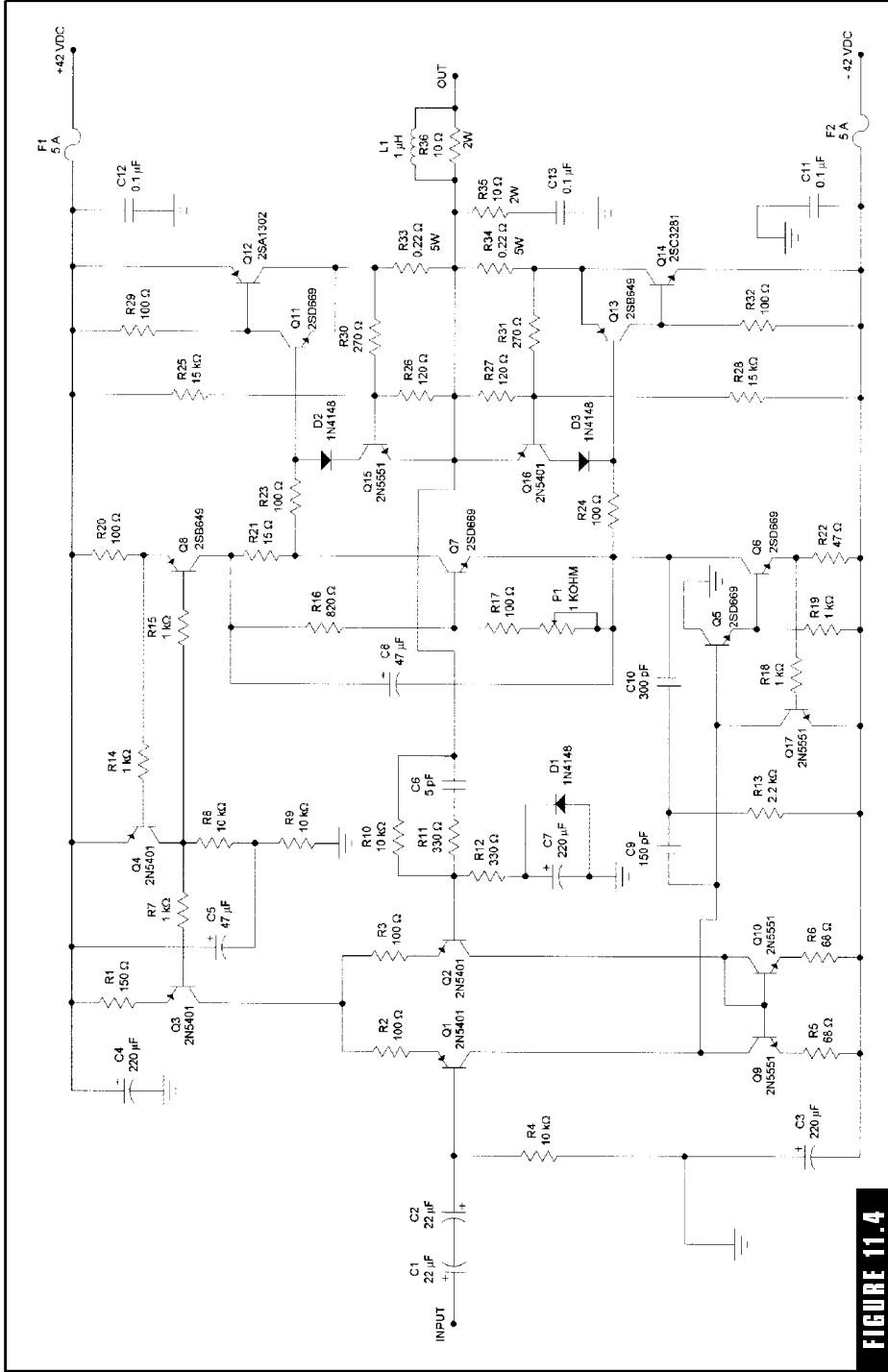

FIGURE 11.4

A very low distortion complementary-feedback amplifier design especially suited for domestic hi-fi applications.

illustrated in the associated distortion charts (Figure 11.5) can be realized. In a nutshell, it boils down to distortion levels for second and third harmonics down into the five-digit region (i.e., four leading zeros!) at 1 kHz, and the two-pole compensation pushes distortion at 50 kHz down to 0.0014 percent for second harmonics and 0.00052 percent for third harmonics. Overall THD is approximately 0.0009 percent.

OPS overload protection is provided by a typical single-slope protection network. The Qbias, pre-driver, and output transistors are connected vertically to the PC board and mounted to a heatsink rated for approximately 0.8°C/watt. Even though thermal tracking accuracy could be improved by mounting Qbias and the pre-driver transistors to a separate heatsink, this method is satisfactory, due to the moderate dissipation level. MJ15003/MJ15004 complementary output pairs can also be substituted for the 2SA1302/2SC3281 devices (that is, Q12 and Q14).

Design 4. A Low-Distortion L-MOSFET Audio Amplifier

The design of Figure 11.6 utilizes the same basic input and VA stage design of Figure 11.4 with an L-MOSFET CF OPS (i.e., lateral MOSFET complementary-feedback output stage). This is typically what most audiophiles call a *hybrid design*, defined as the incorporation of BJTs and MOSFETs in the OPS design.

This design is very conservatively rated for 120 watts RMS maximum output power into an 8-ohm load (at least 200 watts into 4-ohm loads). The low transconductance of the L-MOSFET OPS increases the THD specification up to about 0.006 percent, but I consider this to be a small price to pay for the extraordinary reliability and simplicity of bias considerations associated with L-MOSFET devices. This amplifier is an excellent choice for a high-quality domestic hi-fi application.

A single-slope current-limit circuit provides OPS overload protection (in this case, current-limit protection is needed only to keep from blowing rail fuses in an overloaded condition). Since the OPS design is a CF L-MOSFET type, Q7 need only be thermally coupled to one of the predriver transistors Q11 and Q12. The complementary MOSFET output devices can be mounted to individual heatsinks, if desired.

QUICK TIP

As used throughout this book, the term *hybrid* should not be confused with *hybrid audio amplifier modules*, which, for the most part, are rather ill-conceived class B amplifiers encapsulated in a single modular package.

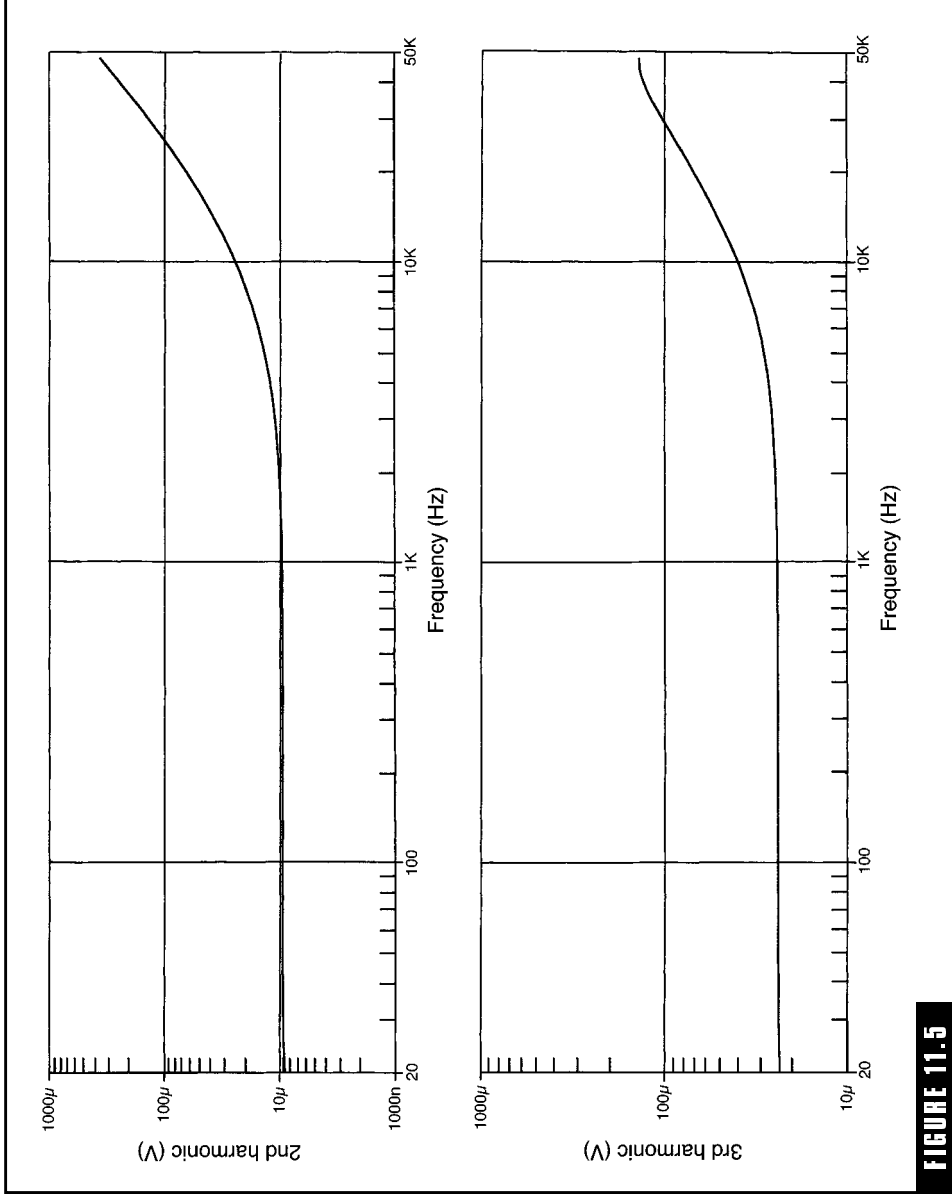

FIGURE 11.5

Distortion graphs illustrating the excellent performance of the amplifier design in Figure 11.4.

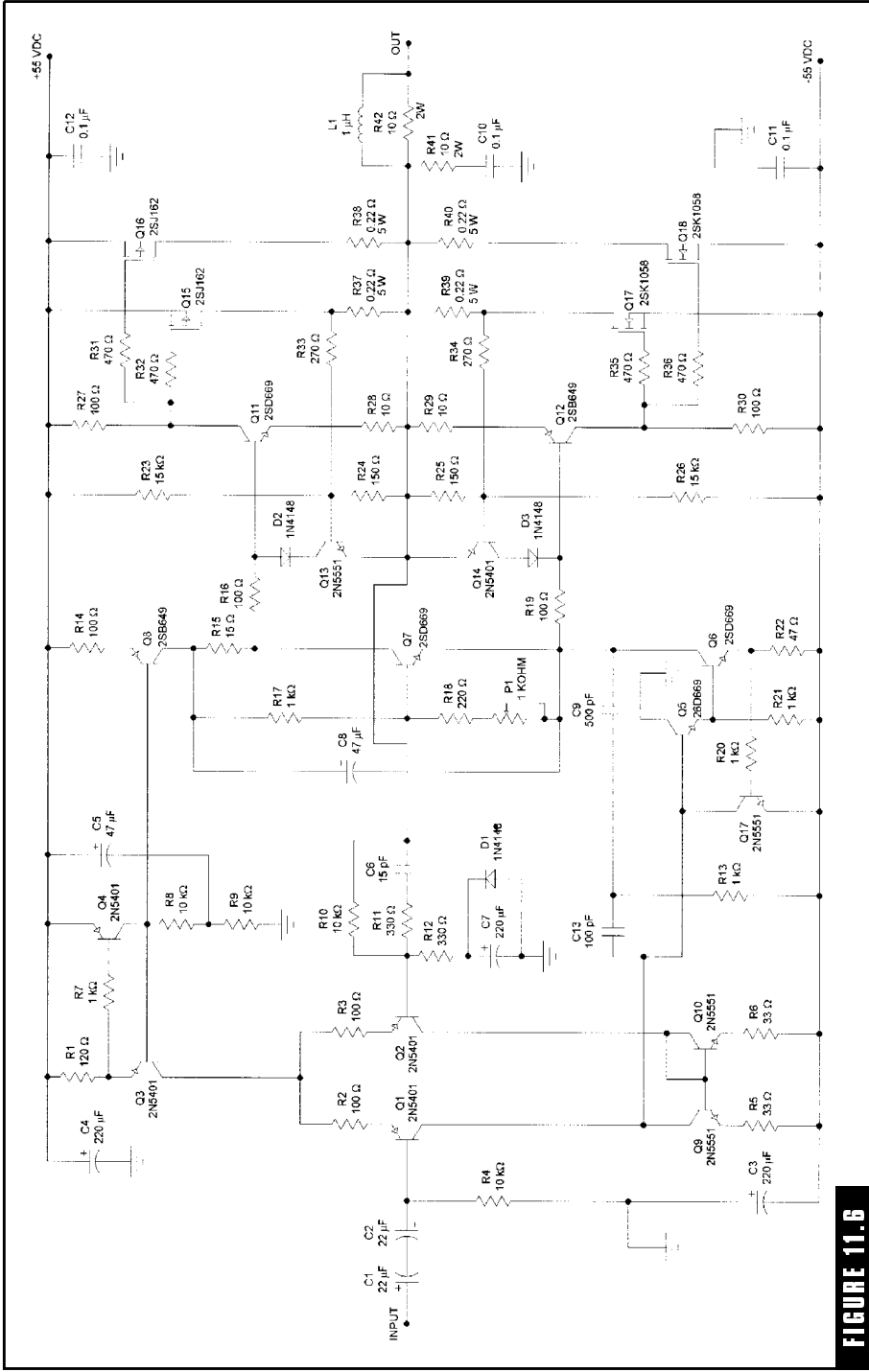

FIGURE 11.6

A low-distortion hybrid L-MOSFET design intended for domestic hi-fi applications. Maximum power output is 120 watts RMS into 8 ohms at 0.006 percent THD.

Design 5. A Low-Distortion L-MOSFET Professional Amplifier

The amplifier design of Figure 11.7 is virtually identical to the design of Figure 11.6. The only design modifications exist in the overload protection circuitry. A multislope protection circuit, as utilized in this design, is preferable to single-slope protection methods for professional applications (i.e., public address amplifiers, monitor amplifiers, musical instrument amplifiers, etc.). The pseudo-current-foldback characteristics of the protection circuit limit the OPS short-circuit current to low levels, meaning that this amplifier will be more tolerant to setup mistakes and long-term OPS short-circuit conditions (not uncommon in multiamplifier professional public address systems).

The compromise involved with this extra-conservative protection approach is the possibility of some protection circuit activation distortion when the amplifier is called upon to power speaker systems with relatively high reactive characteristics. In most cases, this will be very minor (if existent at all) and should not present any destructive dangers to the amplifier or speaker system (i.e., the false-activation periods will be short-lived). With certain types of audiophile speaker systems, false activation distortion may be profound. In these situations, the resistance values of R26 and R32 can be increased to increase the protection circuit's activation level.

Design 6. A Mirror-Image Professional Audio Amplifier

Figure 11.8 illustrates a mirror-image L-MOSFET source-follower design intended for professional applications. This design concept was originally used in conjunction with a BJT OPS, but overall performance is significantly improved by utilizing L-MOSFETs for output devices. Distortion performance is not significantly degraded by this modification since compromises in the input stage design (i.e., primarily, the inferior constant current sources and absence of current mirrors) tend to swamp any noticeable harmonic generation resulting in the loss of some OPS transconductance. However, this offers the advantages of simpler design, easier construction, and lower cost. Maximum power output is approximately 250 watts RMS into a 4-ohm load.

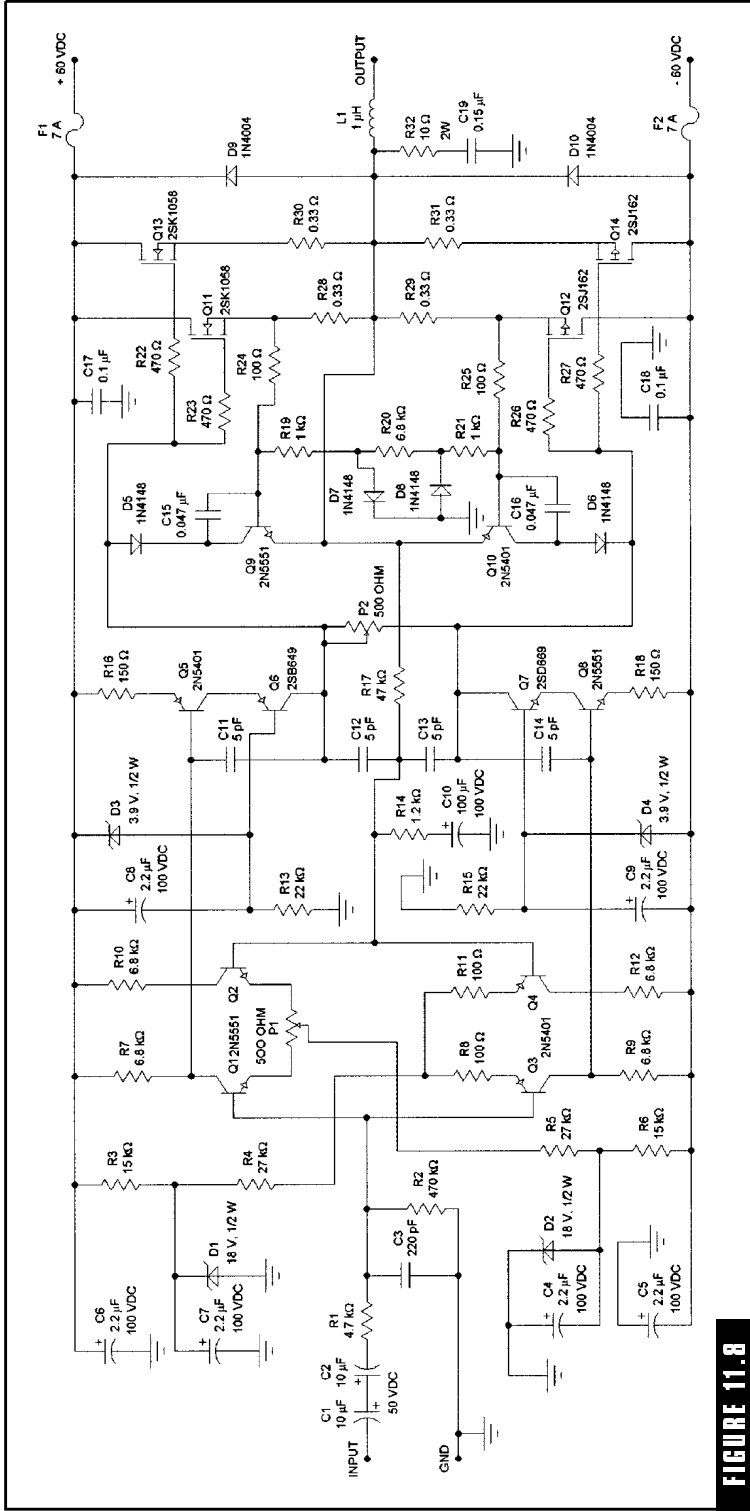

FIGURE 11.8

A source-follower L-MOSFET design intended for professional audio applications. Maximum output power equals 250 watts RMS into a 4-ohm load at 0.02 percent THD.

As in the case of Figure 11.7, if false protection circuit activation becomes a problem, the resistance value of R24 and R25 could be increased to a higher value (that is, 150 to 200 ohms). A first-order input conditioning circuit has been incorporated into this design, which I have discovered to be adequate for almost all practical applications.

The unusual placement of C12 and C13 in this design warrants some discussion. In effect, this is a form of *inclusive compensation* (the provision of some high-frequency NFB from the OPS to the VA stage compensation network, sometimes called “Feedforward Compensation”). It does

little to improve distortion performance, but it is helpful in providing an extra measure of high-frequency stability, which is especially important with MOSFET OPS designs. The high-performance VA stage designs of Figures 11.12 and 11.14 (see later sections) provide much better performance in this respect, but this technique is cheaper. It is common in many commercial amplifiers of this type.

If you would like to construct a high-quality stereo professional public address amplifier, I highly recommend this design. It takes up minimal space, so the installation of two of these units will be relatively easy with a large rack-mount enclosure size. When completed, it will surpass most commercial designs in performance, while being very forgiving of mistakes and relatively simple to construct.

Design 7. A High-Power Professional MOSFET Audio Amplifier

For really high power audio amplifier designs, I make no secret of that fact that I recommend the exclusive use of L-MOSFETs for output stage devices. The design of Figure 11.9 will provide about

**TRADE
SECRET**

In comparison to commercial professional amplifier designs (i.e., the 400 class, referring to at least 200 watts RMS per channel in a stereo configuration), the performance of this design is significantly better than most. The THD is approximately 0.02 percent at maximum output with SNR performance better than -90 dB. This type of performance can certainly be classified as high quality.

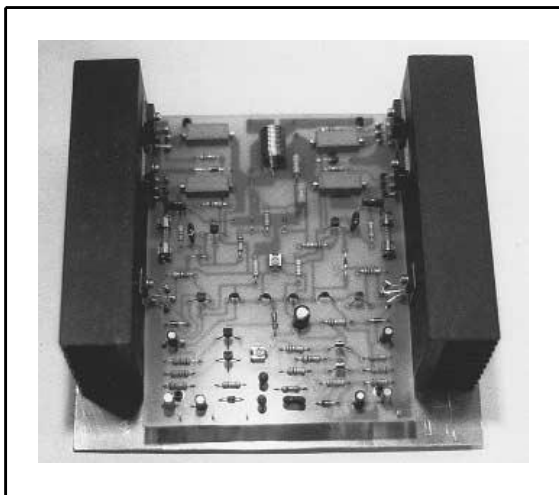

The completed mirror-image professional audio amplifier of Figure 11.8. The artwork for the PC board construction is provided in Appendix C.

550 watts RMS into a 4-ohm load, and it will provide much more reliable performance than virtually any amplifier utilizing BJT output devices of similar power ratings.

This is definitely not an amplifier project for beginners, but if you have aspirations toward building a massive 1.1-kW professional stereo power amplifier, here it is! The cost of the power transformer(s), heatsinks, reservoir capacitors, and output devices will be very high (the cost of the MOSFETs per channel will be approximately \$180). Special considerations must be given to the high-current, high-power dissipation requirements. The recommended minimum connection wire type for power supply and speaker output connections is 12 AWG stranded. L1 should be fabricated from 12-AWG solid core insulated coil wire. If a DC protection-muting relay is incorporated (which I firmly recommend), the minimum DC contact rating per channel should be 30 amps. Also, incorporating this design into any reasonably sized enclosure is going to require massive heatsinks with forced-air convection. It is very wise to add up the total cost of such a project before jumping into it!

Regarding the basic design topology, this amplifier is identical to the design of Figure 11.8, with a few modifications to accommodate the higher output power capabilities (i.e., the values of R24, rail fuse ratings, and RE resistors). It is best to design a PC board layout placing all of the MOSFETs on one side, so that they can be mounted to a flat-sided heatsink that can be installed as one whole side of the amplifier enclosure. In this way, a mirror-image PC board can be designed for the opposite side of the amplifier enclosure, and its heatsink can make up the other enclosure side. Obviously, special precautions must be taken with PC board design to ensure the foil width for the high-current areas is of sufficient current-handling capability. PC board material incorporating 2-ounce copper foil is recommended, with 14-AWG stranded wire soldered to the high-current foil areas as current reinforcement.

The overall performance of this design is very good in comparison to commercial designs of this power rating. Expect the unique characteristics of the very high internal currents to degrade the distortion performance in comparison to the design of Figure 11.8. Typical distortion specifications should be around 0.06 percent when completed. Increasing the capacity value of C4, C6, C17, and C18 will probably add some improvement to this figure.

The omission of Q17, Q18, Q19, and Q20 will provide an amplifier design capable of approximately 300 watts RMS into a 4-ohm load. In this case, the power supply rails are reduced to about 70 volts, with F1 and F2 changed to 8-amp values. Appropriate modifications of the internal hookup wire gauge, muting relay rating, and power supply capacity can be made accordingly.

Designs 8 and 9. Two High-Quality General-Purpose Amplifier Designs

Figures 11.10 and 11.11 both utilize the same OPS design, with identical power output capabilities of approximately 140 watts RMS into 8-ohm loads. VA loading distortion is reduced in Figure 11.10 by the incorporation of a beta-enhancement stage consisting of Q13 and Q15, with transistors Q14 and Q16 performing the identical function in Figure 11.11. Figure 11.10 represents my older MUSAMP design, with Figure 11.11 representing my upgraded version of the same amplifier.

My original intention was to use both of these designs in musical instrument amplifiers (hence, the nickname “MUSAMP”), but they will perform equally well in domestic hi-fi applications. About the only practical difference between the two designs is an improvement of PSRR in the design of Figure 11.11.

Through experience, I have discovered that the 2SA1302/2SC3281 complementary output pairs work equally well in these designs, which may be an important consideration depending on the heatsink style you plan to incorporate.

Typical SNR performance of Figure 11.11 is close to -100 dB with THD at about 0.008 percent. These are both emitter-follower BJT OPS designs, so Qbias (Q8) must be mounted to the OPS heatsink. Q14 and Q16 will require some heatsinking also (typically, almost any standard TO-220 heatsink will be sufficient).

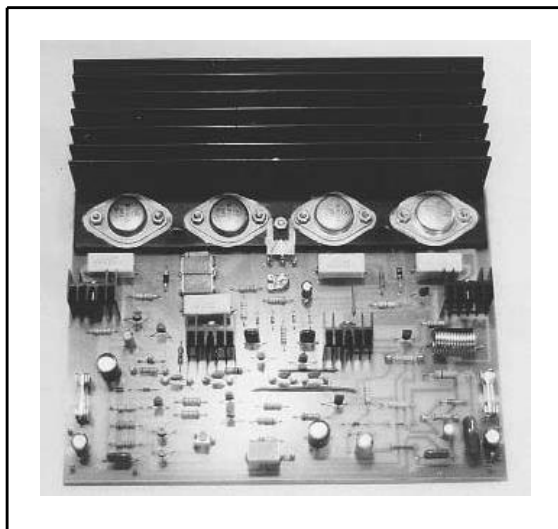

The “MUSAMP” amplifier of Figure 11.11. The artwork for the PC board of this design is provided in Appendix C.

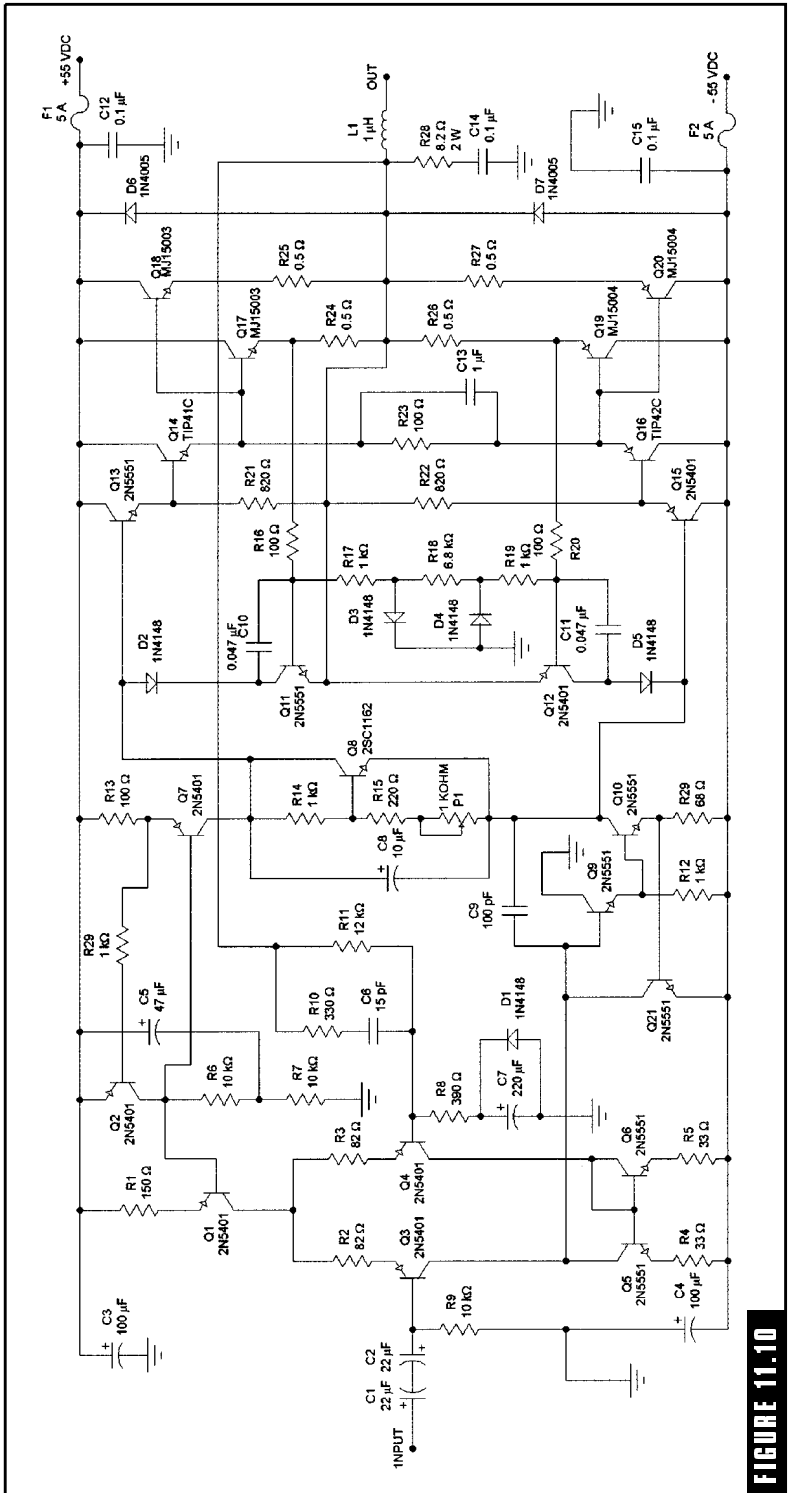

FIGURE 11.10

A BJT emitter-follower amplifier that is an excellent choice for musical instrument amplifiers.

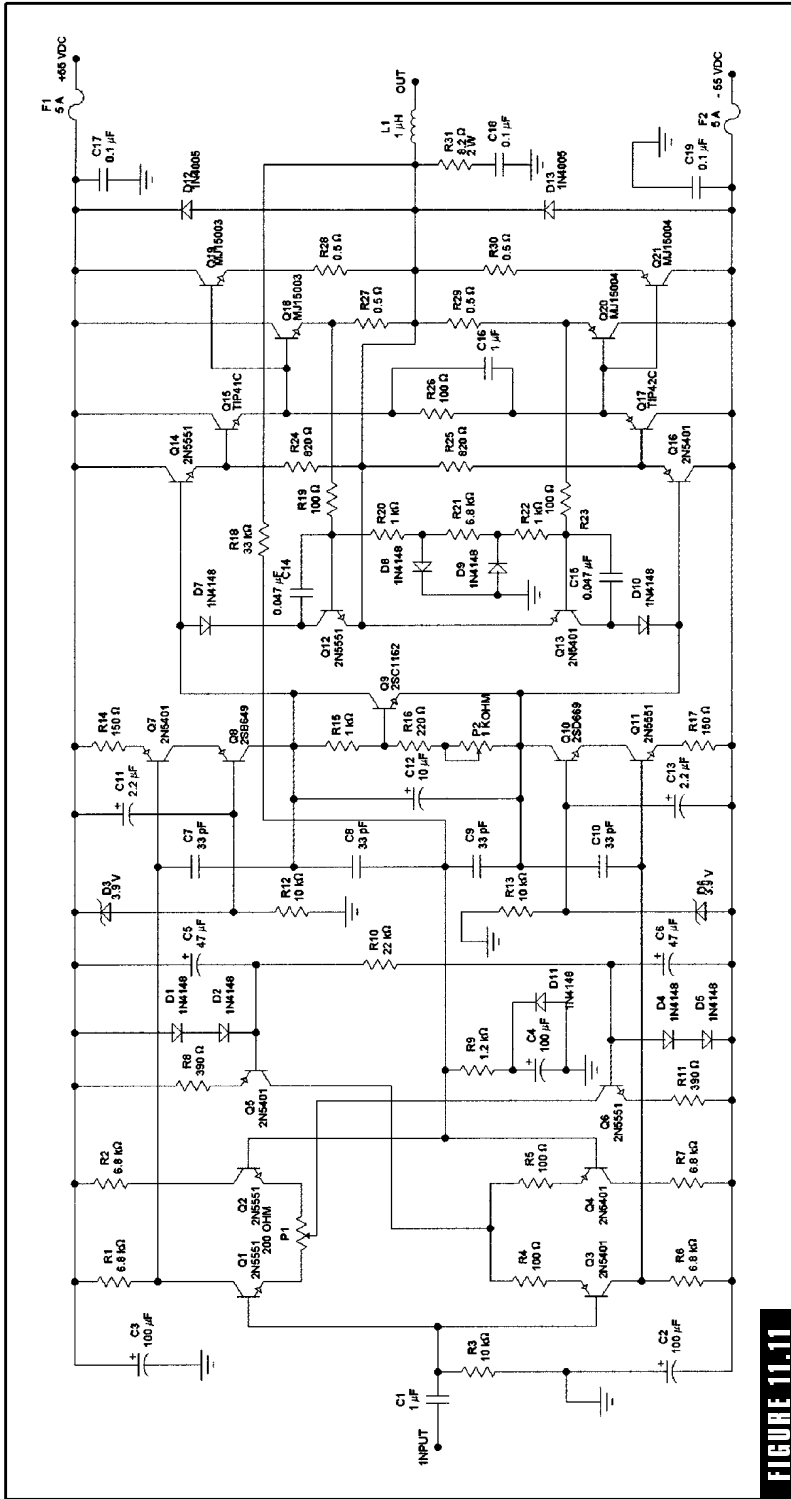

FIGURE 11.11

An upgraded version of my original MUSAMP design of Figure 11.10.

Design 10. A Low-Distortion Emitter-Follower Amplifier Design

The extremely low distortion specifications of Figure 11.4 were partially a result of the high local NFB of the complementary-feedback OPS design. Figure 11.12 illustrates a mirror-image input, high-performance push-pull VA stage combination that squeezes very low distortion characteristics from an emitter-follower OPS design.

There is a combination of factors that contribute to the overall excellent THD performance. The elimination of the beta-enhancement stage for reducing VA loading distortion in the previous two designs was accomplished by utilizing an improved VA design with a lower output impedance and improved slew-rate performance. This improvement reduces OPS phase lag and allows the closed-loop high-frequency response to be extended without risking Nyquist stability problems (the utilization of low-capacitance predriver transistors Q22 and Q23 are also helped in this regard). This means the P1 frequency can be moved up a little, increasing the utilization of high global NFB levels in the upper-frequency realm. Two-pole compensation is incorporated in this design, and this also adds to the high-frequency global NFB levels. In addition, the transconductance of the input stage has been increased, and this provides more open-loop gain to start off with. It is only the inherent stability of emitter-follower output stages that allows such liberties to be taken with Nyquist stability. The happy result of these distortion enhancements is the reduction of the expected increase in THD levels in the upper-frequency realm. Although the THD specification is a respectable 0.0029 percent at 1 kHz, it only triples by the time we reach the end of the audible frequency spectrum (i.e., approximately 0.009 percent at 20 kHz). This certainly represents audiophile performance from an emitter-follower OPS. With the rail voltages illustrated, the maximum output power is about 140 watts RMS into an 8-ohm load.

Design 11. A High-Performance Class A Amplifier Design

In consideration of the extremely high performance levels possible with class B OPS designs, I hope, by now, I have discouraged the

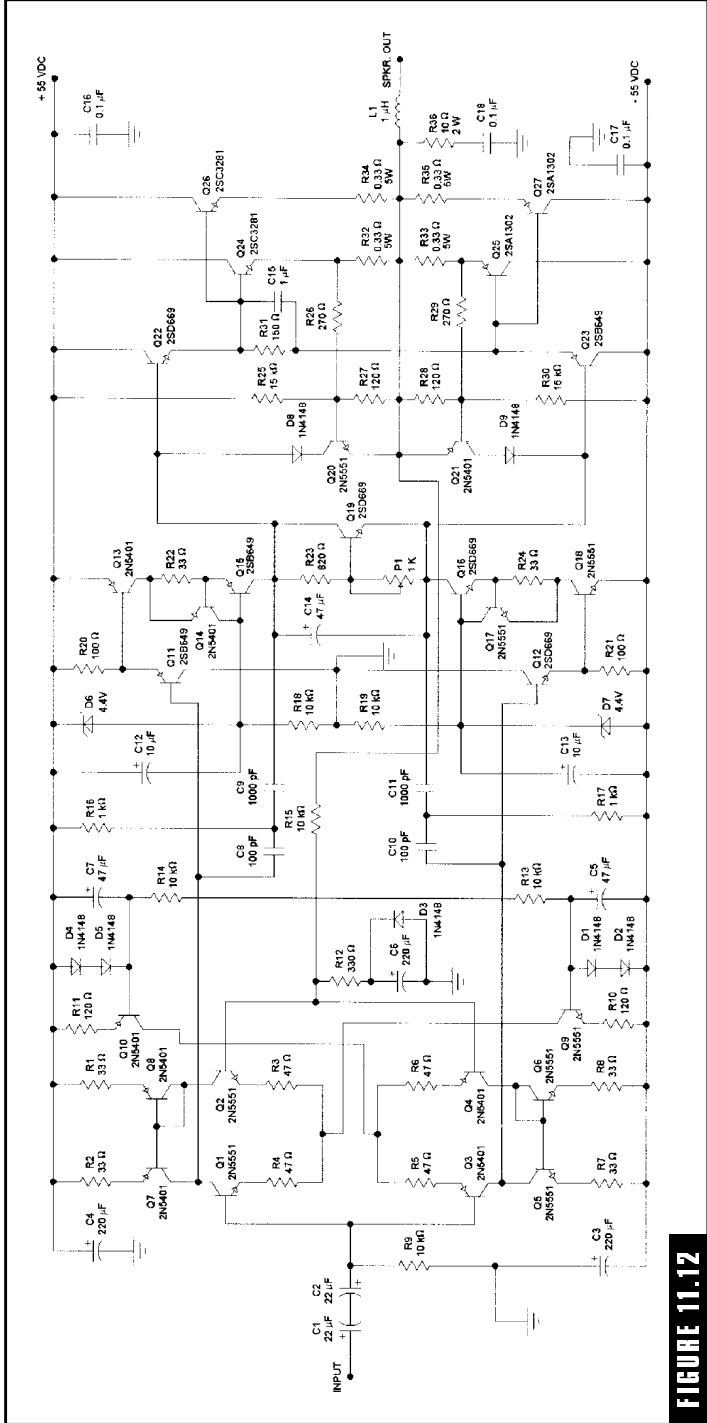

FIGURE 11.12

A high-performance amplifier design, utilizing a mirror-image topology and push-pull VA stage. Intended for domestic hi-fi. Maximum output equals 137 watts RMS at 0.0029 percent THD.

reader from wasting enormous power dissipation in class A models. However, for the class A diehard, Figure 11.13 is an excellent high-performance design. Virtually all of the distortion in this design is a result of the transconductance loss in the OPS due to the unusually high quiescent current levels. (Don't confuse this phenomenon with beta-droop distortion, which is an entirely different problem.)

This is the same design that was presented earlier in the context of class A amplifier designs of Chapter 6, so I won't be redundant in describing it again. I included it here for the sake of convenience in comparing design topologies. If you decide to build this design, don't forget the heatsinking requirements!

Design 12. The Optimum Power Amplifier Design?

What is the “best” audio power amplifier design? I cannot answer that question for everyone, but I can give you my personal opinion. I believe all audiophiles would agree that an L-MOSFET OPS design would be the optimum choice if we could solve the problem of resulting higher distortion levels due to the inherent lower transconductance. This was my goal with the design illustrated in Figure 11.14.

Basically, I incorporated all of the global NFB enhancements previously detailed in the Figure 11.12 design. In addition, I made the OPS design into a hybrid version of a complementary-feedback topology, but the local NFB level had to be reduced to a factor of 10 to maintain good OPS stability. All of these combined factors reduced the THD level to a very respectable 0.0038 percent. In addition, like the amplifier design of Figure 11.12, the expected rise in distortion with increased frequencies is not as great as normally expected, with the THD at 20 kHz coming out to around 0.01 percent. In other words, distortion levels at 20 kHz are about 30 times less than is perceivable by the human ear! Given the outstanding reliability of L-MOSFET devices, the only practical disadvantage of this design over the best BJT designs, in my opinion, is the additional cost of the L-MOSFET devices.

For higher output power applications, two additional complementary MOSFET pairs can be installed into this design. If the power

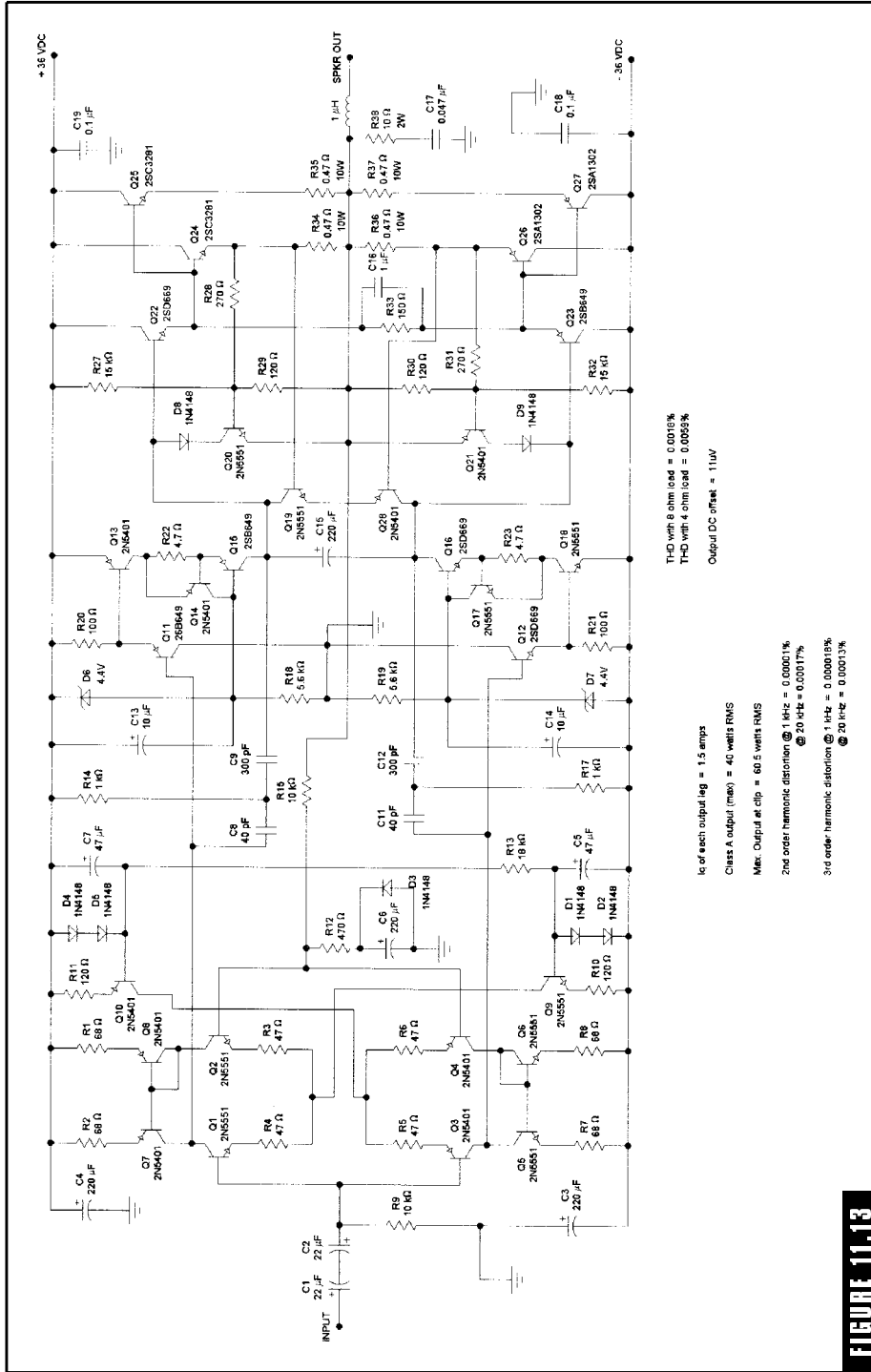

FIGURE 11.13

The high-performance class A 40-watt RMS amplifier of Figure 6.2.

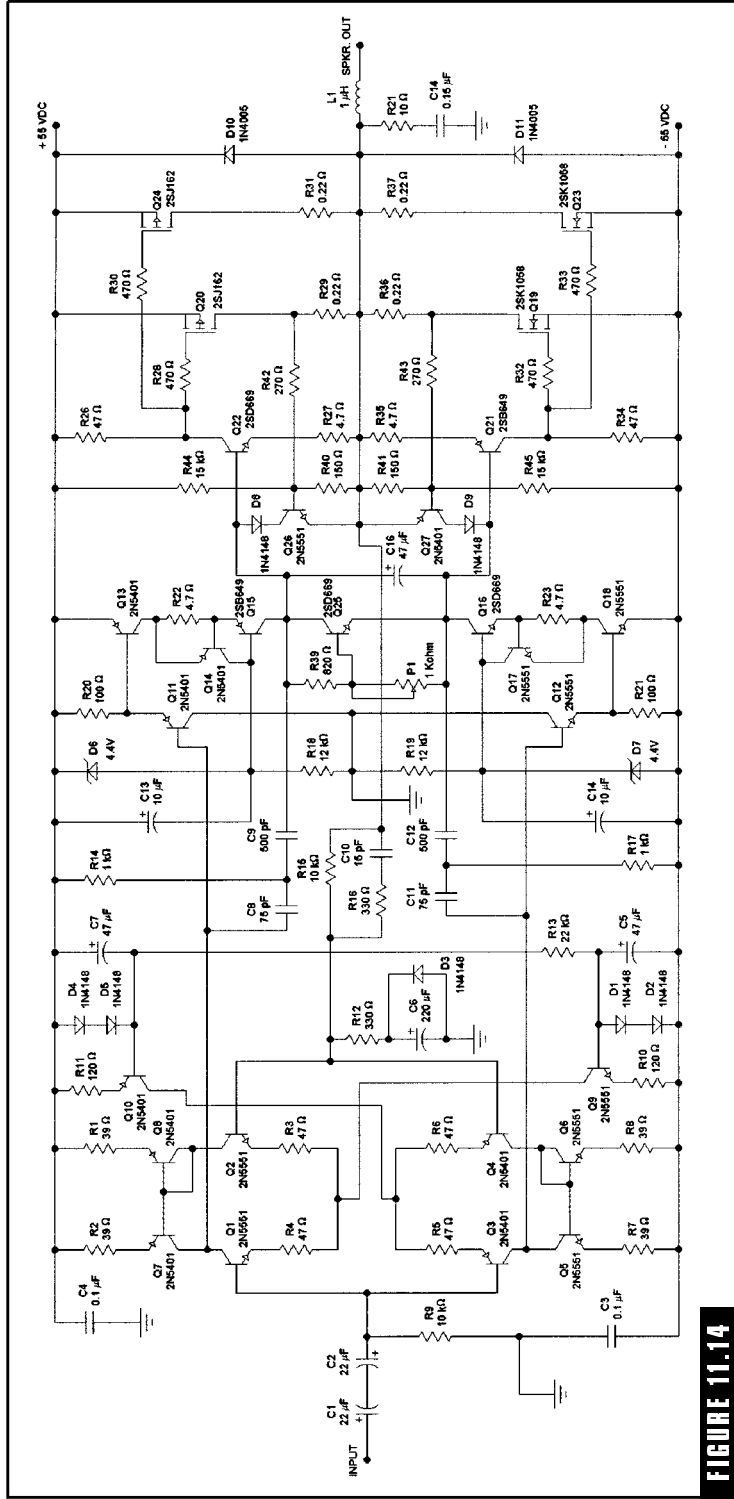

FIGURE 11.14

A high-performance hybrid MOSFET audio power amplifier (an optimized version of Figure 7.6). Provides 0.0038 percent THD at 120 watts RMS into an 8-ohm load.

supply rail voltages are increased to approximately 70 volts, the maximum output power capability will be increased to about 210 watts RMS into an 8-ohm load. Besides the installation of the additional MOSFETs and their associated gate resistors, the resistance value of R43 should be increased to about 78 ohms, with a 2-watt power dissipation rating.

This page intentionally left blank.

Construction Techniques and Considerations

This chapter addresses power amplifier construction on the physical level. Even though the majority of the physical construction attributes belong solely to the realm of personal preference and traditional aesthetics, there are a few performance-related concerns to consider in conjunction with the physical layout. The subject of thermal dynamics relates to both physical and electronic categories, but since heatsinks, convection airflow, and output device mounting techniques are usually thought of as mechanical topics, I decided to include the entire discussion on thermal dynamics in this chapter.

Mechanical Considerations of Thermal Dynamics

Thermal dynamics is of very great concern in the layout and construction of any conventional audio power amplifier. Of immediate concern is the simple fact that if the output devices become too hot, they will summarily expire. The technical name for an overtemperature condition occurring in the OPS is *thermal overload*.

Thermal overloads can occur if the OPS is not electrically protected from overcurrent conditions (i.e., resulting in excessive OPS power

dissipation) when trying to drive load impedances that are abnormally low. I assume that the conscientious builder will adequately protect the OPS in this respect (as detailed in Chapter 8), so we can happily dismiss this danger and go on to other problematic areas.

Another cause of thermal overloads is inadequate protection against thermal runaway in BJT OPSs. In class A amplifier designs, this problem is eliminated with a properly designed I_q regulator circuit. In the case of class B designs, the *amplified diode* (or *V_{be} multiplier bias circuit*, as it is sometimes called) will automatically compensate for increased leakage resulting from temperature rise. Both of these topics have been discussed thoroughly in previous chapters.

Thermal overloads can rapidly develop if the amplifier suffers from some form of high-frequency instability. Self-sustaining high-frequency oscillation can literally blow the tops off of plastic encapsulated power MOSFET devices in less than a minute. However, the overall stability of any power amplifier should be verified during its initial testing and setup procedure, so we can make an assumption that this situation should not arise.

Another possible cause of thermal overloads is an improper adjustment of V_{bias} , placing a class B amplifier into a deep level of class AB operation (i.e., a condition it was not designed to operate within). Again, V_{bias} adjustment should be accurately performed during the setup procedure, but there is always a possibility of component failure within the amplified diode bias circuit.

All of the possible causes of thermal overloads just discussed have been addressed previously throughout the course of this textbook. There is one additional cause of thermal overloads stemming from inadequate OPS heatsinking and/or thermal conduction of the output devices. Generally speaking, these areas of concern are referred to as *thermal dynamics*, defining the heating-cooling cycles of the OPS and the maximum temperature levels that can be realistically expected. These issues will be addressed in the following section.

QUICK TIP

The possibility of thermal runaway does not exist in MOSFET OPSs due to the inherent negative temperature coefficient of power MOSFET devices.

Thermal Resistance

Output stages get hot under normal operating conditions and, unfortunately, heat is destructive to semiconductor devices. Successful audio amplifier projects require

more evaluation of thermal dynamics than just grabbing a big heatsink and attaching a bunch of transistors on it. An accurate design approach to thermal dynamics is not only important to the functional aspect of power amplifier operation, it is also critical to the reliability factor.

All high-power output devices, heatsink insulators, and heatsinks are specified by means of their thermal resistance parameter (R_{TH}). This parameter is always based on degrees centigrade and defines the increase of the device temperature relative to the ambient temperature and power dissipation. For example, an MJ15003 has a thermal resistance specification of $0.7^{\circ}\text{C}/\text{W}$ from junction to case (R_{THJC}). The heat generation in a power semiconductor begins in the semiconductor junction and moves outward toward the casing. The effectiveness of temperature transference from the junction to case defines how much resistance to thermal conductivity is imposed by the internal geometry of the semiconductor device.

Thermal resistance is a ratio defining the rise in temperature relative to each watt of power dissipation. For example, if some hypothetical device happened to be rated a $0.5^{\circ}\text{C}/\text{W}$, it simply means that for every watt that device must dissipate, its temperature will rise by one-half of a degree centigrade. If we caused this same device to dissipate 50 watts RMS, its temperature would rise by 25°C .

When building audio power amplifiers, there are four thermal resistance variables you will need to consider as follows:

1. R_{THJC} = thermal resistance from the junction to the outside casing
2. R_{THCS} = thermal resistance from the casing to the heatsink
3. R_{THINS} = thermal resistance of the semiconductor insulator
4. R_{THSA} = thermal resistance of the heatsink to the ambient air

R_{THJC} has just been discussed as a means of explaining the concept of thermal resistance. It will always be supplied by the manufacturer; thus you have no flexibility regarding this variable. The thermal resistance from the semiconductor casing to the heatsink, R_{THCS} , is variable based on the size of the semiconductor mounting surface, the flatness of the mating surface, and the contact pressure applied between mating surfaces. In the case of high-power semiconductors, the case styles and construction are designed to make this variable low (typically, $0.1^{\circ}\text{C}/\text{W}$).

Output devices will always be physically mounted to some form of heatsink in a high-quality power amplifier. The mounting surface of semiconductor output devices will be electrically connected to one of the semiconductor leads. For example, the mounting surface of a power BJT is the collector. With lateral MOSFETs, the mounting surface is the source, in contrast to V-MOS or D-MOS devices that use the drain for the mounting surface. For a variety of cost and safety reasons, the heatsink will almost always be at ground (0-volt) potential, so some means of electrically insulating the output devices from the heatsink is required. This is accomplished with semiconductor insulators, which provide good thermal conduction while acting as good electrical insulators.

The traditional method of mounting output devices to the heatsink required the use of mica insulators smeared with silicone joint compound (colloquially referred to as *heatsink grease*). While the mounting surface of the output devices and the heatsink may look flat to the naked eye, on the microscopic level they are very rough. Heatsink grease is needed to fill in the gaps and valleys so that a good thermal transference will occur. The more modern method of mounting output devices to heatsinks is with the use of silicone rubber-based insulators, commonly referred to as *silpads*. These are superior to the traditional mica-grease combinations in thermal resistance, and they are certainly less messy and much more attractive. Typically, the thermal resistance of a TO-3 type silpad is about $0.4^{\circ}\text{C}/\text{W}$.

Heatsinks are also rated for thermal resistance (R_{THSA}) in the same manner as output devices and heatsink insulators. For example, a heatsink rated at $1^{\circ}\text{C}/\text{W}$ would rise in temperature (above the ambient) by 50°C if it were required to dissipate 50 watts of RMS power.

When the four previously listed thermal resistances are known, the total thermal resistance from the junction of the output device to the ambient air (R_{THJA}) can be calculated from the following simple summation:

$$R_{\text{THJA}} = R_{\text{THJC}} + R_{\text{THCS}} + R_{\text{THINS}} + R_{\text{THSA}}$$

Let's look at a real-life example. Suppose you wanted to know the total thermal resistance of an MJ15003 mounted to a heatsink with an R_{THSA} rating of $2^{\circ}\text{C}/\text{W}$. Assume the R_{THINS} of the insulator is $0.4^{\circ}\text{C}/\text{W}$ and the R_{THCS} is the typical $0.1^{\circ}\text{C}/\text{W}$. According to the manufacturer, the MJ15003 device has an R_{THJC} of $0.7^{\circ}\text{C}/\text{W}$. Therefore:

$$R_{\text{THJA}} = 0.7 + 0.1 + 0.4 + 2$$

$$R_{\text{THJA}} = 3.2^{\circ}\text{C}/\text{W}$$

Unfortunately, it could be rather difficult to obtain the case-to-sink thermal resistance R_{THCS} and semiconductor insulator thermal resistance R_{THINS} in all situations, as they are not always readily available from the manufacturer or electronics dealer. As a general rule of thumb, these two variables can be estimated with a single value of $0.5^{\circ}\text{C}/\text{W}$ in almost all cases (even if mica insulators combined with heatsink grease are used). Therefore, the only two variables you really need to worry about are the junction-to-case thermal resistance R_{THJC} , supplied by the manufacturer, and the heatsink-to-ambient thermal resistance R_{THSA} of the heatsink.

The most important variable when evaluating the thermal dynamics of any power output stage is the nominal junction temperature of the semiconductor devices. We always want this temperature to be as low as is practically possible. The maximum operating junction temperature will be supplied by the manufacturer. For example, an MJ15003 transistor has a maximum operational junction temperature $T_{\text{J(MAX)}}$ of 200°C . If this maximum is exceeded, the output device will be destroyed by primary thermal breakdown. The nominal junction temperature of the output device can be calculated if the total thermal resistance and power dissipation of the device are known. The equation is as follows:

$$T_{\text{J}} = (P_{\text{D}} \times R_{\text{THJA}}) + T_{\text{A}}$$

where P_{D} = power dissipation, watts RMS

T_{A} = ambient temperature, degrees centigrade

For example, assume the MJ15003 device and heatsink combination used in the previous example was intended to dissipate 50 watts RMS. We already calculated the total thermal resistance to be $3.2^{\circ}\text{C}/\text{W}$. Multiplying this value by the anticipated power dissipation comes out to 160°C of rise in temperature. Adding the ambient temperature (which is almost always assumed to be 25°C), we come up with 185°C . Even though this nominal temperature calculation is lower than the manufacturer's maximum parameter, it is very high. For a reliable audio power amplifier, we would want this temperature to be significantly reduced.

Thermal Dynamics and Heatsink Evaluation

If you purchase new heatsinks from a manufacturer, it is important to know the thermal resistance specifications of the heatsinks under the conditions of moving air and still air. If fan cooling (typically referred to as *forced-air convection*) is incorporated into a power amplifier, the continuous air movement greatly increases the efficiency of the heatsink. Fan cooling requires a little mechanical forethought, since it is desirable for the airflow to be forced through all of the heatsink fins. A mechanically designed systematic airflow pattern within an audio power amplifier is usually referred to as a *wind tunnel*. This is one area of audio power amplifier design that requires some real mechanical creativity. Depending on the heatsink design, forced-air convection can reduce the thermal resistance rating by a factor of two to three times.

Simple *still-air convection cooling* will require some mechanical attention to mounting considerations. The manufacturer's specifications for thermal resistance will apply only if the heatsink is mounted so that it is not starved of any free air circulation. In addition, most heatsinks are specified to be mounted in a certain orientation so that still-air convection can be optimized by the rising of heated air (i.e., what is commonly called a *thermal chimney effect*).

As you will soon discover (if you don't already know it), large heatsinks are very expensive! The majority of audio hobbyists try to find good heatsink bargains in surplus catalogs or by scavenging old equipment. The only problem with this method is that it is almost impossible to obtain the thermal resistance rating of the heatsink. In fact, the chances are that even the name of the manufacturer of the heatsink will remain a mystery. But, with a little ingenuity, there is a way around this problem.

The thermal resistance of an unknown heatsink can be determined with a variac (i.e., an adjustable AC autotransformer), a variety of power resistors (the type intended for mounting to a heatsink), an assortment of small C clamps, some assorted thermal switches, and a DVM. One, or more, power resistors can be temporarily mounted to the heatsink under test by clamping them on to the heatsink surface with a few C clamps. Use a little heatsink grease on the mounting surfaces and use sufficient clamping force to ensure

good thermal conductivity. Temporarily mount a thermal switch to the heatsink surface by using assorted hardware placed through the mounting holes for the semiconductor devices, or tie wraps. Connect the power resistor(s) to a variac, and apply whatever voltage it takes to cause the resistors to dissipate an anticipated amount of power. Allow the heatsink to warm up, and adjust the resistor power dissipation until you can find the stabilized point of the thermal switch's *hysteresis temperature* (i.e., the temperature at which the thermal switch will alternately cycle on and off with only slight changes in dissipation of the power resistors). Record the actual power dissipation of the resistors and the temperature of the thermal switch. With these two known values, the thermal resistance of the heatsink can be calculated.

For example, suppose I mounted a 75°C thermal switch to an unknown heatsink and (with a little trial and error) discovered that it tripped at about a 50-watt dissipation level of the power resistor(s). This tells me that 50 watts RMS caused a rise in heatsink temperature of about 50°C (remember, the heatsink was already at an assumed 25°C ambient temperature). A simple back-calculation reveals that the thermal resistance of the heatsink is about 1°C/W (50 watts ÷ 50° = 1°C/W). Be aware that it will take considerable time to perform this

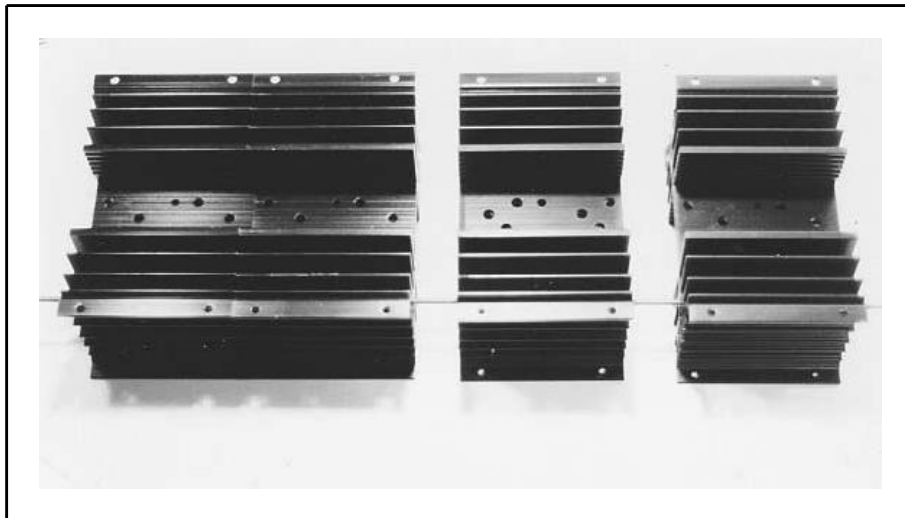

A large heatsink can be fabricated from smaller heatsink sections. In this case, two lengths of threaded rod are used to tightly clamp four smaller heatsink sections together.

test since the thermal mass of the heatsink will cause it to be very slow in reacting to changes in the dissipation of the power resistor(s).

If you happen to own a temperature probe for your DVM, this same testing method can be greatly improved. All that is required is to cause the power resistors to dissipate some reasonable amount of power (say, 50 watts) and measure the temperature increase of the heatsink after it has had sufficient time to stabilize. For example, if 50 watts of power dissipation from the power resistor(s) caused a heatsink temperature rise of 20°C, the thermal resistance of the heatsink is 0.4°C/W ($20^{\circ}\text{C} \div 50 \text{ watts} = 0.4^{\circ}\text{C}/\text{W}$). The utilization of a temperature probe for this procedure is much quicker and more accurate.

When testing an unknown heatsink for thermal resistance, remember to physically orient the heatsink in the way that you anticipate it will be mounted when incorporated into a finished amplifier.

Thermal Dynamics and OPS Evaluation

In choosing the appropriate heatsink for an audio amplifier application, several additional variables must be ascertained. First, you must decide upon the maximum temperature you want the heatsink to reach during the worst-case loading conditions at the OPS of the amplifier.

So far, we have looked only at the junction temperature of the output devices because this is by far the most critical parameter of thermal dynamics. However, it is most likely that the heatsink will become the monitoring element for thermal tracking of the bias circuit and thermal shutdown protection. Therefore, it is necessary to decide on the temperature to activate thermal shutdown based on heatsink temperature.

Previously, I discussed how the extremes of thermal cycling affect the expected life span of a semiconductor device, based on the thermal cyclic curves associated with the specific device. As a rule-of-thumb estimation, for every 10°C reduction in the maximum temperature extreme of a semiconductor device, its theoretical life span doubles. Therefore, if we reduce the nominal heatsink temperature from 90°C to about 70°C, the thermal reliability of the output devices should improve significantly. This is assuming the junction temperatures of the semiconductor power devices decrease by some practical amount.

The anticipated nominal heatsink temperature, calculated based on worst-case conditions, must be somewhat lower than the thermal

shutdown limit. Otherwise, the amplifier will go into thermal shutdown during normal operation, and this is certainly an undesirable condition on a chronic basis. Many manufacturers set the thermal shutdown point in their amplifiers at 100°C, designing the OPS to nominally operate at around 90°C under fully loaded conditions. I like to set the thermal shutdown point at 75°C and run at about 70°C, since this is a practical goal and adds a safe margin of security in the long-term reliability of the amplifier. This is a personal decision, and I am sure many audiophiles would rather abide by a slightly different approach. Regardless of your choice, it is a decision that must be made before progressing onto the final phase of thermal design.

The last piece of information needed is a good estimate of the *total power dissipation* (i.e., wasted heat) of the OPS. This estimate must be made before the amplifier is constructed; otherwise, you could waste considerable time and money in retrofitting the design at a later time. It would be very time-consuming and expensive to fix if it were discovered that the OPS heatsinks are too small after the amplifier project had already been constructed.

In the case of class A amplifiers, the calculation of OPS wasted heat is relatively straightforward. The quiescent OPS current flow (I_q) is simply multiplied by the voltage drops of the output devices, with the summation of these products equaling the total OPS power dissipation. Unfortunately, the task of coming up with a good estimate of the power dissipation requirements of conventional class B OPS designs can be quite complex. From a theoretical viewpoint, a well-designed class B OPS could be up to 78.5 percent efficient at maximum power output using a continuous sine wave input signal. In the real world, however, around 74 percent efficiency is a more plausible percentage, deteriorating down to about 68 to 70 percent for lateral MOSFET OPSs. The causes for the less-than-optimum efficiency are the power wasted by the bias current (this is more significant in EF and MOSFET OPSs), ballast resistors, and the residual voltage drop (and coincident power loss) of the output devices in a fully on state.

The traditional method of amplifier output power calculation is based on a continuous sine wave input signal. It should be remembered that a continuous sine wave is not a good representation of nominal program material, such as speech or music. Due to the wide dynamic range in conjunction with the various lulls and voids existing

in all typical program material, the average power delivered to a speaker load may only be 60 to 70 percent of the power that would be generated by a continuous sine wave at the same output voltage level.

It is easy to calculate the maximum output power delivered to a specific load impedance based on the rail voltages and an assumed OPS efficiency of 100 percent. This ideal output power value could then be reduced to its corresponding real-life expectation and the left-over power dissipation could be considered wasted heat. Unfortunately, this method isn't very accurate for two reasons. First, the power supply droop under heavy load is an unknown variable. Second, OPS efficiency drops off as the output power is reduced, causing the practical worst-case condition (i.e., the maximum anticipated heat dissipation that must be endured by the OPS) to occur at a power output level of 40.7 percent. This corresponds to the output voltage level being at 64 percent of its maximum level below clipping (-3.9 dB below clip). At this point, the OPS efficiency is at 50 percent.

There are other methods of creating worst-case conditions. For example, a 1-kHz square wave signal (50 percent duty cycle) driving the amplifier to 50 percent of its full output power will cause the OPS efficiency to drop to 50 percent. This test could not be considered a practical worst-case test, however. While it is conceivable that a highly compressed program source could produce conditions roughly equivalent to a sine wave at 64 percent of the maximum voltage output, it is totally inconceivable that a power amplifier could ever be continuously driven with a square wave in a real-world application.

Another variable is the dependence of the OPS power dissipation on the load impedance. If the OPS is called upon to drive 4-ohm loads under worst-case conditions, there can be as much as a 4 to 1 increase in wasted heat compared to the same OPS under nominal signal conditions (i.e., typical music and speech programs) driving 8-ohm loads. Naturally, the contrast becomes much greater if the OPS is applied to driving 2-ohm loads.

To the best of my knowledge, there isn't any standard methodology or traditional rule-of-thumb technique for coming up with a quick solution to the numerous ambiguities involved with estimating OPS power dissipation before the amplifier is constructed and tested. Several prominent audio engineers simply disregard all the calculations

involved with thermal resistance (assuming R_{THJA} to be ideal), calculate a rough estimate of total OPS dissipation, and purchase a heatsink with a thermal resistance rating that will theoretically cause it to reach about 75°C based on the rough estimate. Another prominent audiophile calculates a first-order maximum power dissipation for 4-ohm loading and uses 50 percent of this value as the estimated OPS dissipation. Commercial manufacturers have the luxury of fine-tuning the OPS through repeated trial-and-error testing until the desired results are obtained. Obviously, this approach is too expensive and time-consuming for the average audio hobbyist.

My personal philosophy is that a high-quality amplifier should be capable of driving 4-ohm loads under practical worst-case conditions on a continuous basis without tripping the thermal overload protective circuitry. Using this design goal as a beginning foundation, we can use Figure 12.1 as a design example in determining the heatsink requirements for a typical class B OPS. Referring to Figure 12.1, the following procedure can be used:

- 1.** Under practical worst-case 4-ohm loading, there will be some power supply droop. This will not be as prominent as when the amplifier output power is at maximum, but it will be significant. As a rule of thumb, begin by decreasing the power supply rail voltages by 10 percent. Therefore, for calculation purposes, the power supply rails in this example are assumed to be 50 VDC.
- 2.** With 50-volt rails, the maximum peak output signal voltage would be approximately 50 volts. Calculate the RMS equivalent of a sine wave signal with a peak value of 50 volts. This comes out to 35.35 volts.
- 3.** Calculate 64 percent of the RMS equivalent voltage. The answer comes out to 22.6 volts.
- 4.** Square the 64 percent RMS voltage value, and divide it by the 4-ohm load impedance to calculate the estimated 40.7 percent power level. In this example, the estimated practical worst-case power level is 127.69 watts. Under these conditions, the OPS can be assumed to be at an efficiency level of about 50 percent. Therefore, the practical worst-case OPS dissipation will also be about 130 watts (127.69 watts can be rounded off for ease of calculation).

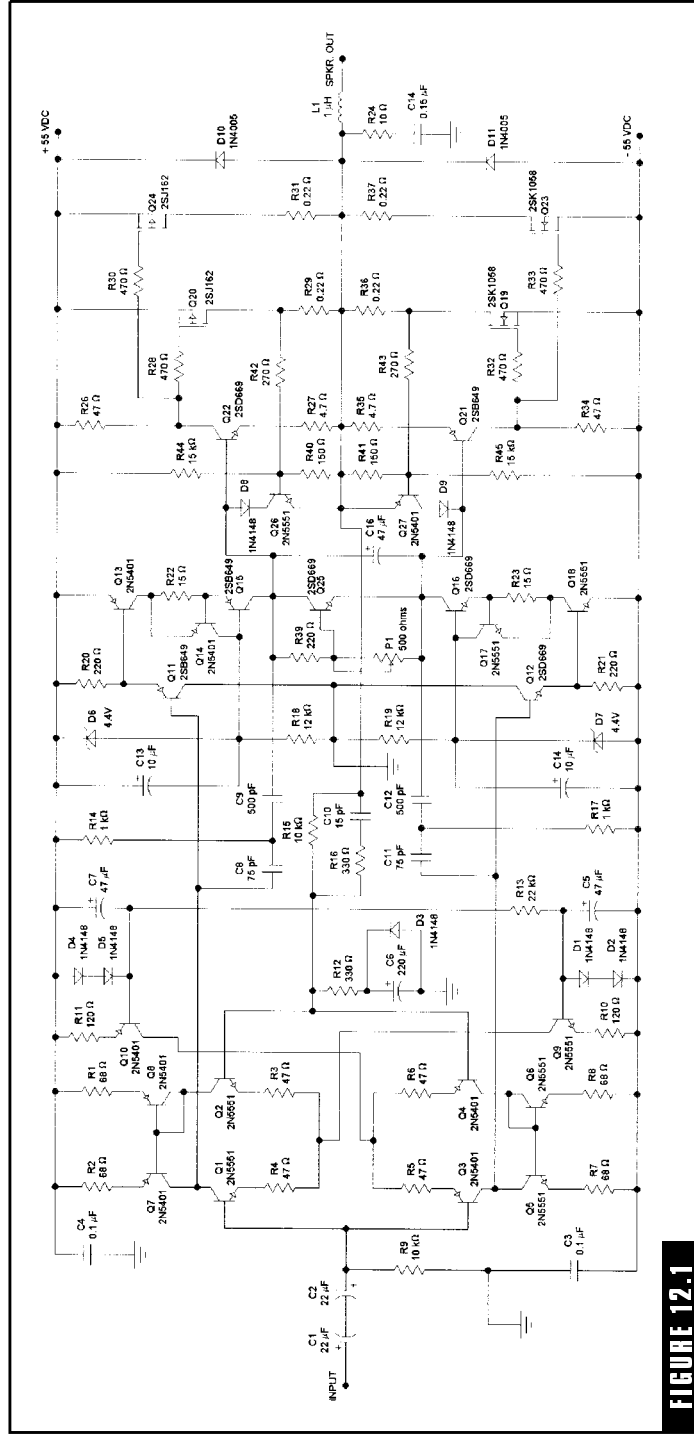

FIGURE 12.1

The hybrid amplifier of Figure 7.6(a) used as an example for the calculations of OPS heatsinking requirements.

5. A rough estimate of the heatsink's thermal resistance can now be made for calculation purposes. Since we don't want the heatsink's temperature to rise more than 45°C (45°C + 25°C = 70°C), 45°C can be divided by the previously calculated 130 watts to come up with approximately 0.35°C/W.
6. Because OPS dissipation is estimated at 130 watts and four output devices are incorporated (see Figure 12.1), each output device will have to dissipate approximately 32.5 watts RMS (assuming symmetry).

In the remaining discussion, it will be assumed the output devices, insulators, and heatsink have the following thermal resistance specifications:

$$R_{\text{THJC}} = 0.7^\circ\text{C/W}$$

$$R_{\text{THCS}} = 0.1^\circ\text{C/W}$$

$$R_{\text{THINS}} = 0.4^\circ\text{C/W}$$

$$R_{\text{THSA}} = 0.35^\circ\text{C/W}$$

7. Since it is assumed that all four output devices are going to be mounted to the same heatsink, individual junction temperature calculations will require the thermal resistance of the heatsink to be multiplied by 4. In other words, R_{THSA} , as used in calculating R_{THJA} , must be made to equal 1.4°C/W.
8. Calculate $R_{\text{THJA}} = 0.7 + 0.1 + 0.4 + 1.4 = 2.6^\circ\text{C/W}$.
9. Calculate the individual junction temperatures for a power dissipation of 32.5 watts RMS (4 devices \times 32.5 watts = 130 watts total OPS dissipation). 2.6°C/W multiplied by 32.5 watts = 84.5°C. Adding the 25°C ambient temperature, we come out with a final answer of 109.5°C.

The thermal mass of the heatsink is so much greater than that of the output devices or insulators that we can consider them negligible in dissipating any significant portion of OPS power directly to the ambient air. Therefore, the total dissipated power is assumed to be thermally conducted to the heatsink.

10. Calculate the maximum temperature of the heatsink. $0.35^{\circ}\text{C}/\text{W}$ (R_{THSA}) \times 130 watts = 45.5°C . Adding the 25°C ambient temperature, we come out with a final answer of 70.5°C .

The importance of the calculations that have just been performed is twofold. First, you can be assured that you will not exceed the critical junction temperature of the output devices under the conditions specified as worst-case (the maximum operational temperature of the lateral MOSFETs specified in Figure 12.1 is 250°C). There are certainly situations in which you would want to use 8-ohm loading as worst-case, for example, or possibly 2-ohm loading. For commercial hi-fi applications, you may want to calculate thermal dynamics based on nominal music or speech signals. Second, this relatively simple methodology ensures the accurate purchasing (or allocation) of heatsinks to fit the application. Besides the cost involved, no one wants to rework a finished amplifier project.

It is almost certain that commercial manufacturers would say I was too generous with heatsinking, and many esoterics will probably suggest that I could have been more conservative. This is irrelevant. The important issue is that a methodology is provided here so that the hobbyist can plug in his (or her) personal goals and make the amplifier project turn out as expected.

Thermal Overload Protection

The easiest way to incorporate good, reliable thermal overload protection is with a speaker load disconnect system based on a thermal switch. The thermal switch monitors the temperature of the OPS, disconnecting the speaker load in the event of a thermal overload. Once the speaker load is disconnected, the OPS heatsink(s) and output devices should automatically cool until the thermal switch resets, restoring normal operation.

Thermal switches are a type of automatically resetting thermostat. Internally, they are made up of a stationary contact and a contact mounted to a bimetallic strip. The *trip temperature*, sometimes called the *activation* or *set-point temperature*, is the preprogrammed temperature that causes the internal relay contacts to toggle. Thermal switches are very inexpensive and available in a wide variety of set-point temperatures and case styles. They can be purchased in either a normally open or normally closed configuration.

Thermal switches can be mounted to the case of one of the output devices or the heatsink. If mounted to an output device case, the typical set-point temperature is between 100 and 150°C. If mounted to the heatsink, the typical temperature range is between 75 and 100°C. If possible, it is best to mount the thermal switch to the case of one of the output devices to reduce the effects of thermal delay.

Although some manufacturers utilize thermal switches to break the AC line power in the event of a thermal overload, I do not recommend this method. The preferred method is to use the thermal switch contacts to drop out the muting–DC-protection relay. Several circuits providing such protection are discussed and illustrated in Chapter 8.

Some esoteric amplifier designs incorporate optoisolators or various types of solid-state switches into the amplifier design to effectively mute the output signal if a temperature sense voltage indicates a thermal overload. The temperature sense voltage can be obtained from a wide variety of thermistors, temp-resistors, or diodes. These temperature-sensing elements may be used in conjunction with op-amp or transistorized comparator circuits for calibration purposes. In more recent designs, the LM35DZ integrated temperature sensor is becoming popular, because it can be read directly and doesn't require any type of calibration. However, the only motivation for going to this elaborate thermal overload design is the desire to eliminate the use of a DC-protection relay. I believe the elimination of a muting–DC-protection relay to be a bad idea from every perspective, so I consider there to be little motivation for going to more complex thermal shutdown circuitry.

If fan cooling is incorporated into an amplifier design, a second thermal switch mounted to the OPS heatsink can be used to thermostatically control the cooling fan. For this application, the second thermal switch should have normally open contacts, and its set-point temperature should be lower than the set-point temperature of the thermal switch used for thermal overload protection. The normally open contacts are placed in series with one of the fan wires, so that the fan will not start running until the heatsink reaches the set-point temperature (usually about 50° to 60°C). The object to this modification is to keep the fan turned off when the amplifier is used at low power levels, thus eliminating irritating fan noise.

face of the predriver transistor will always track the predriver junction temperature better than the heatsink will.

With EF OPS designs, it is virtually impossible to mechanically mount Qbias to the top of a TO-3 case-style output device. Consequently, Qbias is usually mounted to the heatsink in a location as close as possible to one of the TO-3 output devices. A better method is to modify a small TO-3 heatsink (the four-cornered type designed for one TO-3 device) or a piece of aluminum L bracket that can be sandwiched under the TO-3 device being monitored for thermal tracking. This is illustrated in diagram C of Figure 12.2. The L bracket or small TO-3 heatsink then becomes a mounting bracket for Qbias. Since there will always be some thermal resistance between the mounting bracket and the OPS heatsink, the mounting bracket will respond more rapidly to temperature changes of the TO-3 device. The thermal resistance between the mounting bracket and OPS heatsink must be very low. Otherwise, the nominal operating temperature of the TO-3 device being thermally monitored will be much higher than the remaining output devices in the OPS. This condition will produce a lopsided thermal-tracking accuracy and do more harm than good.

It is normal for the output devices to rise in temperature faster than the OPS heatsink(s). The thermal mass of the heatsink will be much

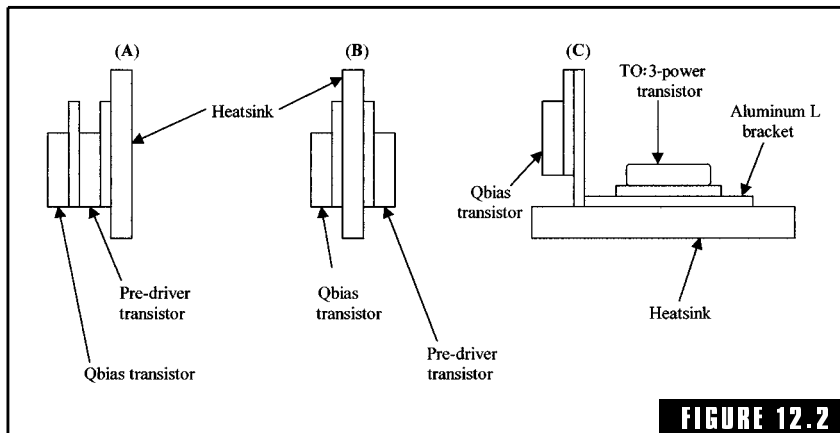
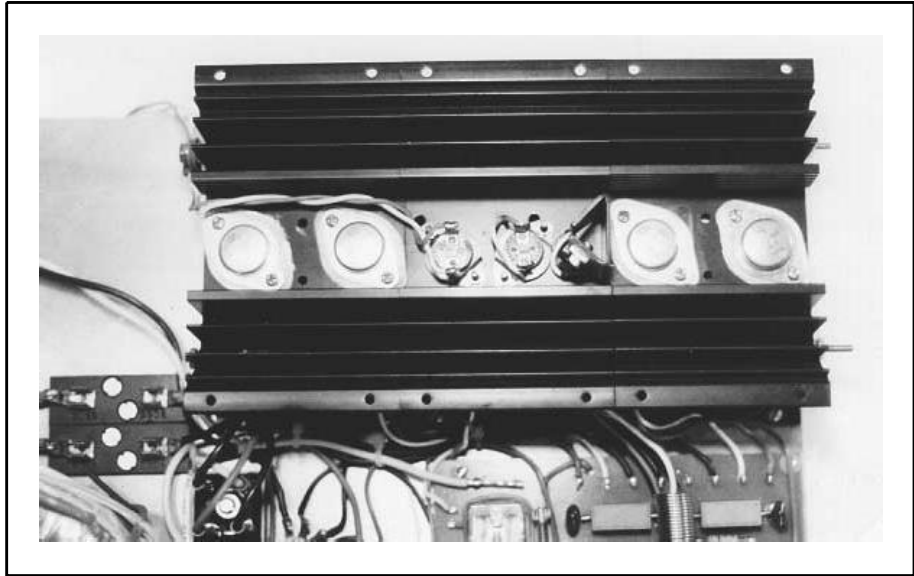

FIGURE 12.2

Three methods of obtaining good thermal coupling between the monitored transistor temperature and Qbias. A illustrates a piggyback configuration. B illustrates a back-to-back configuration. C illustrates a method of reducing thermal error and delay by using a modified smaller heatsink or aluminum L bracket.



A 200-watt BJT heatsink assembly. Note how Qbias is mounted to one corner of a small modified TO-3 heatsink sandwiched under the second output transistor from the right. Also note that there are two thermal switches mounted in the middle section of the heatsink. One is used to activate fan cooling at 60°C, while the other provides automatic thermal shutdown at 75°C through the DC protection–muting relay.

greater than the thermal mass of the output devices, so it will take considerable time for the heatsink to stabilize in proportion to the output devices. In some amplifier designs, this could take as long as 10 minutes. As shown earlier in the OPS power dissipation calculations, the maximum junction temperature (or operating temperature) of the output devices will always be higher than the temperature of the heatsink(s), due to the thermal resistance between the junction temperatures and the heatsink surface.

Printed Circuit Board Construction

Many electronic hobbyists have a real problem when it comes to making printed circuit boards. I am convinced that the root of the problem stems from bad experiences with cheap beginner's kits that offered little chance for success in the first place. I am not going to go into elaborate detail of PC board construction in this book—there are many good books and reference sources on this subject. However, I do want

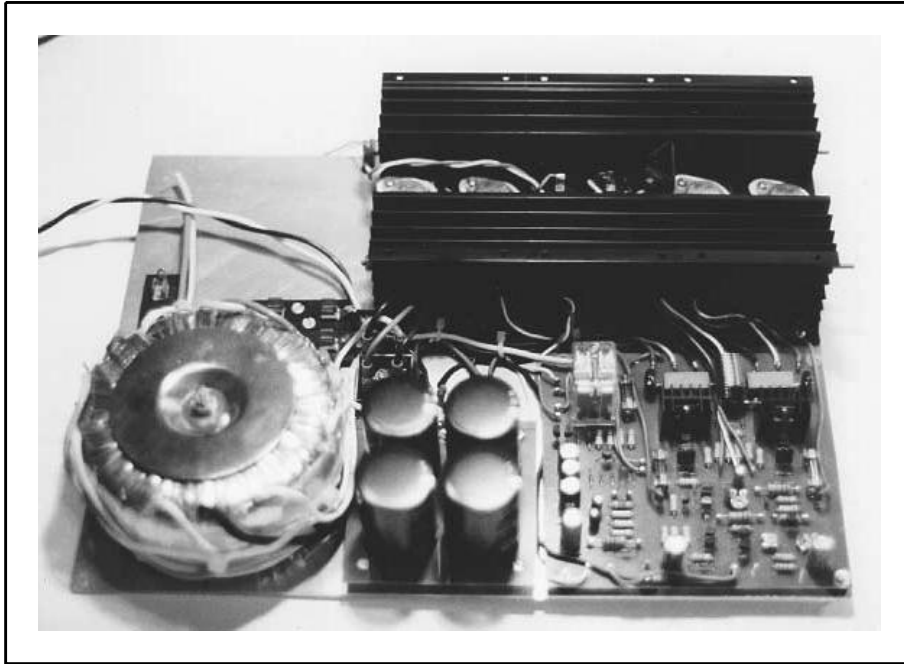

In this 200-watt amplifier design, note that holes were drilled through the side of the heatsink to shorten wire length and maintain good wire separation. The connection wire insulation should be the high-temperature type if this method is used.

to explain the best method of producing good PC boards for the amplifier projects contained in this book.

The PC board artwork for some of the amplifier designs of this book is included in Appendix C. These are all single-sided designs, which makes the whole process much easier. For anyone contemplating breadboarding the circuit designs using perfboard and flea clips, I will say that it can be done. I know this firsthand because I breadboarded several of the designs years ago, and they functioned very well. However, your chances of error are greater, and it is simply a waste of an enormous amount of time. If you have the right tools and materials, a top-quality PC board can be produced in a few hours or less, especially if you are making two or more at a time.

If you are not an adventurous person and are dead-set against making your own PC boards, etched and drilled PC boards for the amplifier projects in this book are available from Seal Electronics. The address and phone number are provided in Appendix D.

Generating Printed Circuit Board Artwork

For the serious audiophile hobbyist, there is only one viable option when it comes to generating customized PC board artwork—do it with a computer! With the widespread availability of home computers today and the low cost of CAD programs developed especially for this purpose, it has become the height of obstinate inefficiency to pull out graph paper and drawing tools to accomplish this task by hand. Modern layout programs not only speed up the entire process but they also check the accuracy of your design using “netlists” generated from the original schematic. Chances of design error are almost eliminated.

Excellent layout programs capable of multilayer design and extraordinary versatility are available for less than \$400. Differing types of less sophisticated layout programs start at around \$100, but you must be careful that they will meet your specific needs. For example, some programs offer excellent versatility, but only in conjunction with small PC boards that may not be adequate for large power amplifiers. I use the *Electronics Workbench Layout* program, but there are other layout programs available that vary in cost and performance. It is wise to speak with a representative of a software company to ensure that their layout program is well suited to your personal applications.

Etching Printed Circuit Boards

For the noncommercial amplifier builder, the following is the best method I am aware of for producing high-quality PC boards:

1. Generate the PC board artwork using a CAD layout program. Specify “pads with holes for prototypes.” This will greatly aid in drilling the PC board after the etching process is completed. Specify a “reflected image” printout. This will convert the artwork to a bottom view, which is what you will need for the photo-exposing process.
2. Print the artwork onto a clear transparency. Transparencies are available at almost any department store or office supply store. They are typically used with inkjet printers to make colored transparencies for overhead projectors. In this case, the inkjet transparency will become a photo-positive of the PC board artwork. Print the artwork onto the transparency as dark (opaque) as possible. Whenever I print out

the artwork, I run the transparency through the inkjet printer twice. This helps to fill in any voids and increases the opacity. However, I am not sure how well this double-printing process works with all inkjet printers.

3. Hold the transparency up to a light and carefully check for voids or semiopaque areas in the artwork. If you see small pinholes or semi-clear areas, touch them up with a permanent ink marker.
4. For the photo-exposing process, you will need a 150- to 200-watt floodlight, a clear pane of glass at least as large as the PC board, a presensitized positive-acting PC board blank, and photo-developer solution for positive-acting photoresist. Most electronic supply companies carry these supplies (with the exception of the floodlight and the pane of glass, which you can easily obtain locally).
5. Cut the PC board blank to the required PC board size. Hang the floodlight about 10 to 12 inches above the exposure area. Peel off the protective film from the presensitized area of the PC board blank. Lay the artwork transparency on top of the presensitized area. (Make sure you don't have the artwork upside down! I make that mistake quite frequently.) Lay the clear glass pane on top of the transparency, causing the transparency to lay perfectly flat on the presensitized surface. Turn on the floodlight, and expose for approximately 10 minutes.
6. Immediately submerge the exposed PC board into the developing solution. Within a minute or so, you should see the exposed photoresist wash off into the developer solution, leaving a clear pattern of the PC board artwork. As soon as the exposed areas are clean of photoresist (exposing the bright copper foil), remove the PC board from the developing solution and wash in cold running water.

Note: If you happen to be a novice at this procedure, it is best to cut out a few small pieces of presensitized PC board material and go through a few trial runs of steps 5 and 6. For optimum results, you may find you have to increase the exposure time, increase the floodlight distance to the PC board surface, or make other adjustments. This is an easy and relatively inexpensive process. After only a few experiments, you should be capable of making PC boards like a pro.

QUICK TIP

If you want to build some of the amplifier designs in this book using the artwork provided in Appendix C, you can copy the artwork onto a clear acetate sheet with a copying machine. This creates the photo-positive. Then, starting at step 3, continue through the same procedure that has just been detailed.

7. Submerge the PC board in a copper etchant solution. Etchant solution is usually a ferric chloride-based solution. Be careful with this stuff! Believe me, it will permanently stain everything it comes in contact with. Don't get it on your skin or in your eyes—wear goggles and rubber gloves. Pour the etchant solution into a glass or plastic tray; don't allow it to come in contact with any metals except the copper foil

on the PC board. Etchant solution can be purchased in dry or liquid form in various concentrations, so follow the instructions on the packaging label. Etchant solution works best if it is warmed. I usually pour it into an oven-safe glass tray and set the tray on a small hotplate to keep it warm. Do not boil it or inhale the fumes! Using some type of rubber or plastic tool (I use an old rubber spatula), keep the solution agitated and frequently check the progress of the PC board. In about 10 to 15 minutes, the etchant will have eaten away all of the unprotected copper foil. At this point, remove the PC board and wash it in cold water. A steel wool soap pad can then be used to remove the photoresist.

8. Drill holes in the PC board to facilitate insertion and mounting of the electronic components. If you anticipate constructing a lot of PC boards, you should invest in a small drill press for this task. A hand-held drill will work equally well, but your arm will get mighty tired before the job is over with. The hole size should be slightly oversized in respect to the component lead diameters.

Mechanical Layout of a Completed Audio Amplifier

The mechanical design and layout of an audio power amplifier is a highly individualistic and personalized affair. My intentions in this section are not to try to tell anyone how to design the mechanical layout of an amplifier project. The purpose of this section is to provide some helpful hints that may improve the overall performance (and possibly avoid a problem or two).

Figure 12.3 illustrates a top view of a typical generic high-power stereo audio amplifier. There are many other good methods of mechanical layout, but we can use this hypothetical layout as a foundation for discussing a few performance considerations.

To begin, note that the line cord, line fuse, power switch, power transformer, and bridge rectifier are all mounted close to each other in the rear of the amplifier enclosure. It is desirable to mount all of the AC mains devices and power supply components in close proximity to each other, keeping this entire mounting area as far removed as possible from the low-level signal, high-impedance areas (i.e., the input and VA stages) of the power amplifier. The right and left amplifier PC boards are mounted so that the input stages and VA stages are close to the front of the enclosure area; thus the physical distance between these areas and the power supply and AC mains devices is maximized.

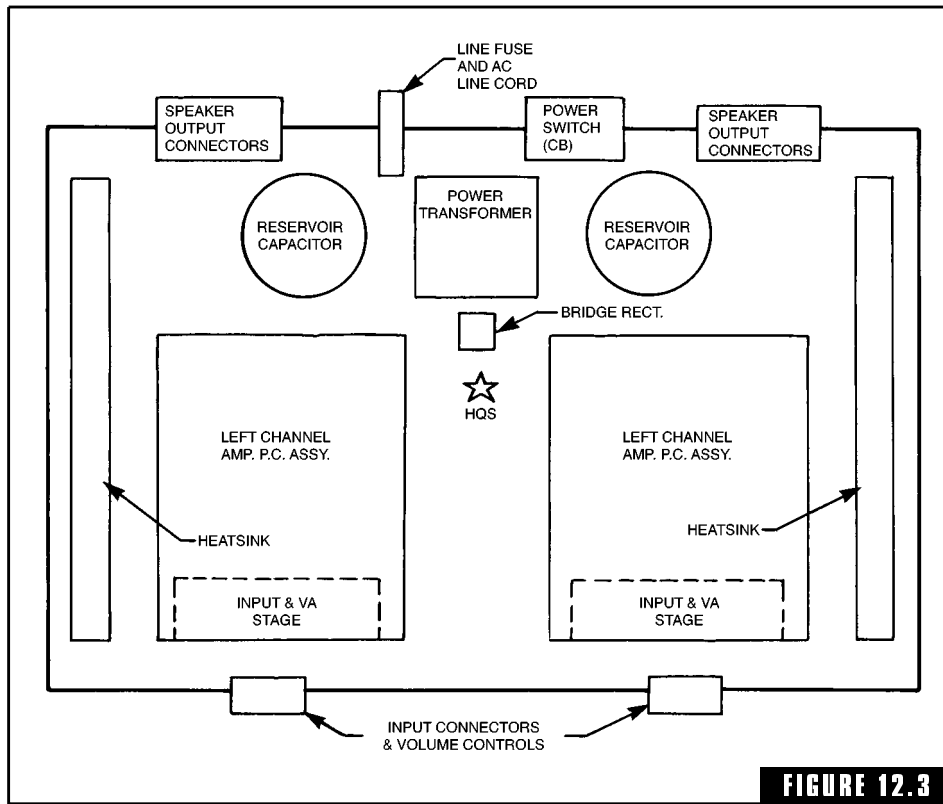

FIGURE 12.3

Typical mechanical layout for a generic stereo high-power amplifier.

In most commercial audio power amplifiers, the positions of the power switch and input connectors are reversed from Figure 12.3. This is a convenience issue since it is usually more convenient to route the input signal lines to the rear of the amplifier (especially if the amplifier is rack mounted) and turn the amplifier on and off from the front. With good wiring techniques and appropriate care to keep the critical wire runs separated, this can certainly be accomplished without any significant degradation in performance with almost any amplifier layout design. However, the purpose of Figure 12.3 is to illustrate the best possible approach, leaving it up to the builder to make any compromises he or she sees fit.

With the input connectors and volume controls (if incorporated) mounted to the front of the enclosure, the length of the signal wire run is kept to a minimum. Most important, it isn't possible for the input signal wire to come anywhere near the power transformer or AC mains wiring. Many older professional power amplifiers were constructed in this manner, and it still remains the best method from a performance perspective.

The importance of this context is not to debate whether or not it looks tacky to plug input lines into the front panel of a power amplifier. The principle of keeping the input wires away from the power supply and AC mains wiring is the important point. You may want to mount the power supply and power transformer to one side of the amplifier enclosure in an effort to accomplish the same goal. There are many other good options also.

The high-quality ground point, or star point, illustrated in Figure 12.3, is located in a good central and accessible location. There will be several return lines connected to this point from both amplifier PC boards and the power supply, so it is good to make it centrally accessible.

Many amplifier designs utilize a circuit breaker to perform the dual function of providing AC mains overcurrent protection and serving as the power on-off switch. This technique is a good approach because it then becomes impossible for anyone to replace a blown AC fuse with another of the wrong value.

Note: The replacement with the wrong-value AC fuse is not usually done in error. Many misguided consumers think that they can force a power amplifier back into functional operation with a larger fuse if it keeps blowing the recommended fuse type. I have actually found alu-

minum chewing gum wrappers inserted into the fuse holder (this is a so-called helpful hint passed along by many professional entertainers)! Commercial amplifier manufacturers are justifiably concerned about this danger, so they forgo the additional expense of a circuit breaker to eliminate the problem.

If you decide to use a circuit breaker for the on-off switch, it should be mounted to the rear of the amplifier enclosure.

Heatsinks will always take up a large portion of the available enclosure space in a high-power audio amplifier. If the amplifier design does not incorporate forced-air convection, it is important to ensure that the mechanical layout will facilitate efficient still-air convection cooling. This is usually accomplished by exposing the heatsink fins to external portions of the enclosure (i.e., the sides or rear of the enclosure). Some amplifier designs mount the heatsinks

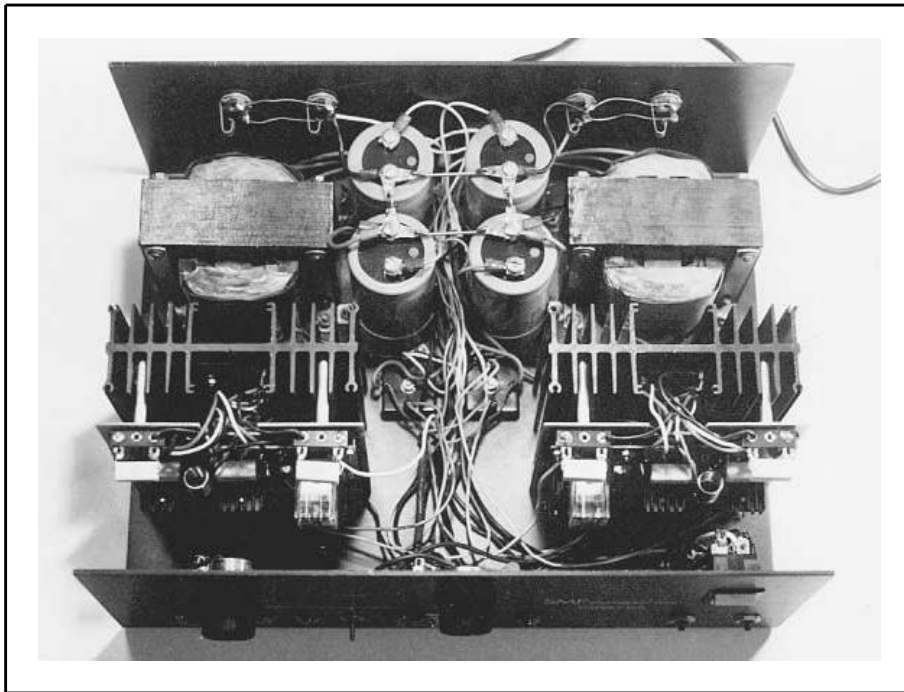

A top view of a professional power amplifier. Note how the power supply components are mounted in the rear of the chassis. The input jacks and volume controls are mounted on the front panel.

inside the enclosure and provide upper and lower air vents in the top and bottom of the enclosure panels. In these cases, it is extremely important to keep the top and bottom airflow unrestricted. I recommend the custom mounting of small rubber feet on the top and bottom panels of such amplifiers, thereby making it impossible to block the airflow by contact with a flat surface.

Wiring Methods for Audio Power Amplifiers

Hum problems in audio power amplifiers are often the result of improper ground wiring in a completed amplifier system. Figure 12.4 illustrates the correct method of providing adequate return wiring to the various internal amplifier sections.

Note that the common connection of the power supply reservoir capacitors is wired to the *high-quality ground (HQG) lug*. You do not want the HQG point to literally be the common connection point of the reservoir capacitors because of the high charge-current turbulence at

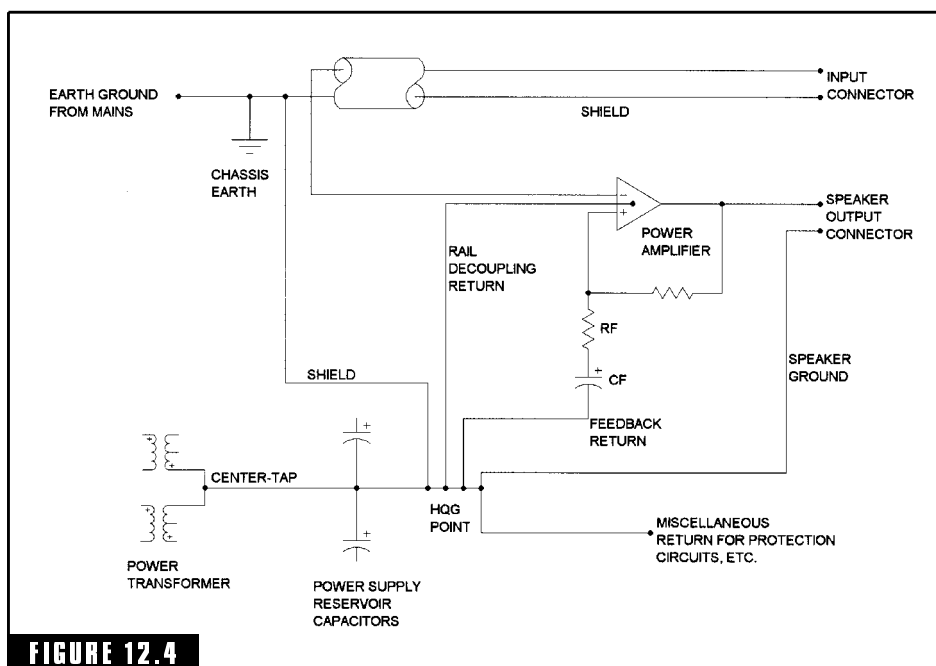

FIGURE 12.4

Preferred grounding method for a typical high-power amplifier.

this point. The connection wire running from the reservoir capacitors to the HQG point should be very heavy gauge.

Although most of Figure 12.4 is self-explanatory, a few areas of confusion can be made clear by a comparison to Figure 12.1. The rail decoupling capacitors in Figure 12.1 are C4 and C3. The grounded side of these capacitors should be connected together and wired as a separate return to the HQG point. This return is labeled “rail decoupling return” in Figure 12.4. Any additional rail decoupling capacitors should also be grounded through this same return line.

R12 and C6 in Figure 12.1 are illustrated as RF and CF in Figure 12.4. The grounded side of C6 should be connected to the HQG point through its own return, labeled “feedback return” in Figure 12.4.

The chassis earth wire should be connected to the input cable shield wire as close to the input connector as possible (preferably, soldered directly to the input connector). When performing connection wiring to various protection circuits, always make certain that return lines for relay coils are on a separate return (labeled “miscellaneous return”) in Figure 12.4.

The positive and negative rail voltage wires (running to the individual amplifier PC boards) should be twisted together and kept away from other sensitive wiring. Do not twist these wires around the individual power supply ground wires running to the PC boards. Keep individual ground wires separate and physically removed from the rail voltage wires.

This page intentionally left blank.

Power Amplifier Diagnostic Equipment and Testing Procedures

A Reminder about Safety

Testing and troubleshooting audio power amplifiers are the most dangerous facets of power amplifier construction. It is during these procedures that AC mains power is live and you will be exposed to lethal high-voltage, high-current connection points. The internal connection or test points are often difficult to reach in cramped spaces, exaggerating the possibility of accidentally coming in contact with high-voltage points. Inadvertently touching hot resistors or high-voltage points can cause reflexive jerks that can cause even worse injury. Accidental short-circuits or incorrect voltage polarities across the reservoir capacitor(s) can cause explosions resulting in permanent eye damage, and these capacitors can hold dangerous charges for weeks. Many types of wiring or construction errors could even start a fire.

As I have previously stated, this book is not the place to learn basic electronics. It is assumed the reader already has a good electronics foundation, which includes a good working knowledge of electrical safety procedures. If you are inexperienced in electrical safety or have any questions about the safe way to perform any of the following tests, measurements, or adjustments, do not attempt the procedures explained in this chapter. Electrical safety cannot be learned by trial and error any more than skydiving can be learned by trial and error. Also, if you haven't read the section entitled "Safety Considerations" in Chapter 3 of this book, please do so and follow the instruction it contains.

Practical Considerations of Required Test Equipment

Throughout the processes of building, testing, and evaluating the amplifier projects contained in this book, some electronic test equipment will be required. Most electronic enthusiasts will already have the essential items—namely, a good oscilloscope, low-distortion signal generator, and DVM. Depending on your personal interest in audio power amplifier construction, these essential items may be as much as you need. For instance, I certainly wouldn't recommend that anyone go to the expense of purchasing a distortion analyzer if he or she wants to build only a few of the simpler projects.

I am not going to provide a long (and boring) list of recommended hand tools, soldering irons, PC board repair materials, etc., in this chapter. Likewise, the fundamentals of using common electronic test equipment and basic electronic troubleshooting methods are intentionally absent throughout the course of this book. These subjects are found in many hobbyist-oriented magazines and textbooks. If you are a novice and would like an easy-to-understand fundamental companion in these areas, I highly recommend the following publication:

Gordon McComb's Tips and Techniques for the Electronics Hobbyist,
by Gordon McComb

ISBN 0-8306-7485-3 (hardcover) or 0-8306-3485-1 (paperback)

Available from McGraw-Hill, Inc.

McComb's book also includes an extensive and detailed section on electrical safety. Please study it and abide by it.

To those who anticipate a serious involvement in audio amplifier design and construction, there are some pieces of specialized or semi-specialized test equipment that you will need to acquire as you progress toward professional levels of sophistication. The following discussion is targeted toward test equipment that I have found to be indispensable throughout the years.

A *variac* is helpful when performing initial testing or troubleshooting procedures. The term *variac* is a colloquial abbreviation for a *variable AC autotransformer*. In using a variac, it should always be remembered that it does *not* provide AC isolation. (If electrical isolation is needed, a variac must be plugged into an isolation transformer.) For tests involving high-power audio amplifiers, I recommend a variac with not less than a 10-amp current capability (approximately 1.4 KVA) and with an integral AC current meter. These are commonly available from a variety of electronic test equipment suppliers.

During the construction phase of building audio power amplifiers, optimum performance can be improved in many cases by the use of matched output pairs (i.e., BJT complementary output devices with beta values verified to be within 10 percent of each other or complementary MOSFET devices with similar forward transconductance values). All the amplifier designs in this book contain such high levels of global NFB that the incorporation of matched complementary output pairs is not a critical issue, but beta-matching of current mirror transistors is always necessary. There will also be situations in which you will want to measure the parameters of output devices (possibly unknown devices with in-house part numbers) for replacement or testing purposes. These types of analyses require the use of some type of semiconductor parameter testing apparatus. Semiconductor analyzers can be very expensive, but I have found the relatively inexpensive Sencore TF46 Super Cricket to be adequate for almost every need of the audio amplifier builder. The Super Cricket will functionally test all types of output devices (BJTs, enhancement and depletion mode MOSFETs, JFETs, and diodes) and provide the parameters for matching complementary pairs and/or verifying in-specification values (such as beta and leakage parameters). It cannot test voltage breakdown parameters, but the amplifier builder will seldom run into problems with primary voltage breakdown if the semiconductor manufacturer's specifications are not exceeded. The cost of a Super Cricket is roughly about \$500.

Adequate testing of capacitors and inductors is impossible without some type of specially designed capacitor-inductor analyzer. It is often necessary to measure leakage characteristics of electrolytic capacitors (sometimes ESR also), which requires the application of high voltages to the capacitor under test. Custom-made air core inductors used for amplifier output chokes or passive crossover networks (i.e., for speaker systems) require a specialized analyzer to provide accurate inductance value measurements and Q specifications. Sencore's line of Z Meters do a very good job of meeting these needs, but they are also moderately expensive (depending on the model, prices will vary around \$1200 to \$1800). Unfortunately, there simply aren't any less expensive alternatives for these types of analysis measurements.

DC power supplies are needed for almost any type of electronic design, test, or service application. However, high-power audio amplifiers require voltage and current levels far above the capabilities of typical bench power supplies. When starting a new amplifier project, many hobbyists simply construct the project's power supply first and subsequently use it for testing and analysis of the amplifier sections. This technique is certainly the most cost-effective method of accomplishing various project goals. However, the serious and long-term audio enthusiast will encounter situations wherein it is highly desirable to test a new audio amplifier design before going to the trouble and considerable expense of building a custom power supply. In addition, the actual project power supply will not contain protective current-limiting circuitry required for safe testing of new amplifier designs.

Variable high-voltage, high-current, current-limiting power supplies are rather hard to come by, especially at affordable pricing. Consequently, I decided to design my own bench power supply for amplifier testing purposes. The complete schematic for this power supply is illustrated in Figure 13.1. Each of the four current-limited outputs is set (by the value of R7, R8, R9, and R10) to approximately 1.5 amps, which is below the secondary breakdown current of the series pass transistors. The current-limiting circuits are identical to the current-limiting protection circuits incorporated into many amplifier VA stages, except, of course, for the maximum current levels. The series pass transistors will dissipate considerable heat if the current-limit values are exceeded, so they should be adequately heatsinked. The remainder of the design is a very straightforward dual-polarity raw DC power supply.

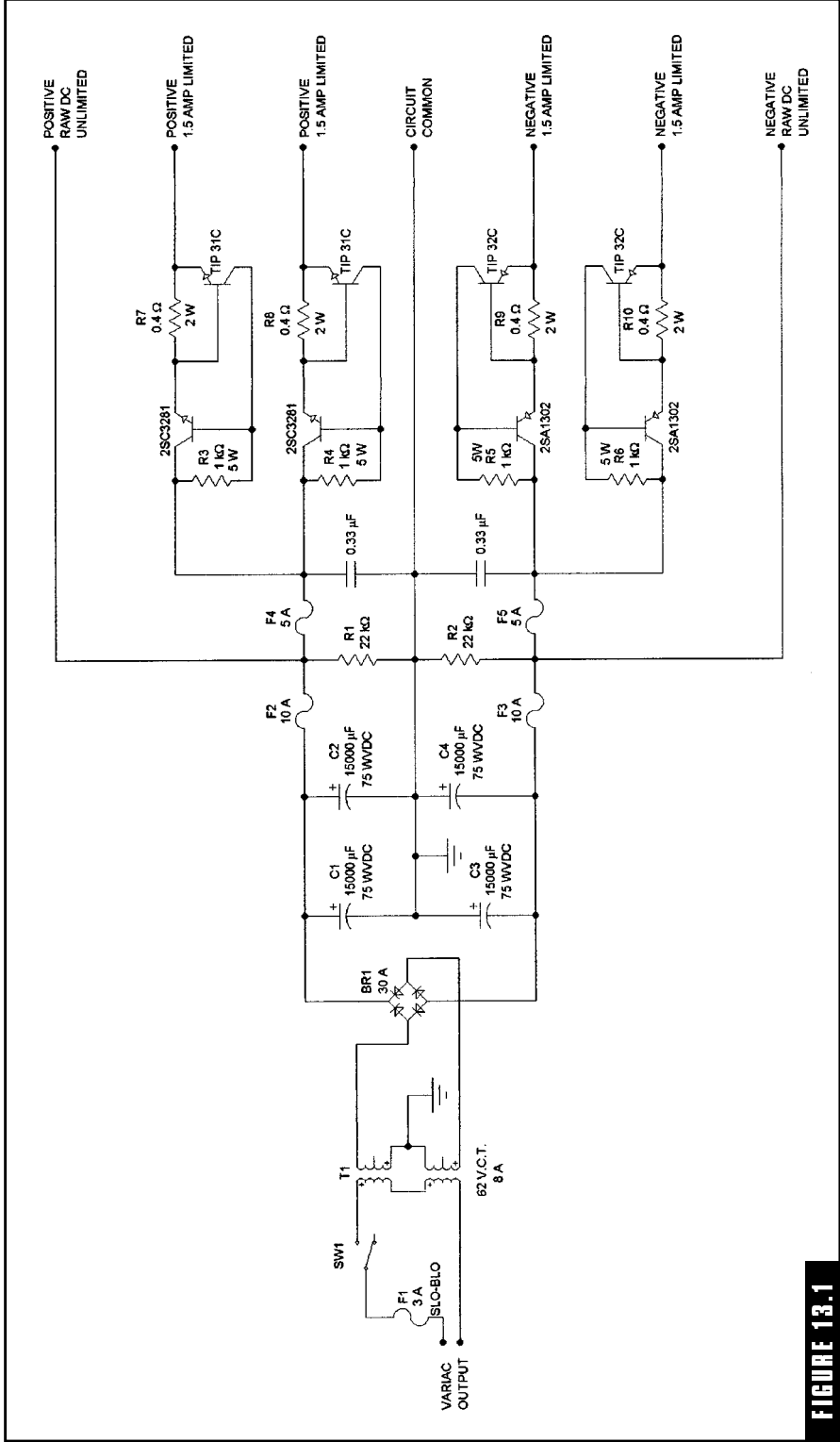

FIGURE 13.1

A current-limiting bench power supply for testing and setup of audio power amplifiers.

The power supply of Figure 13.1 is intended to be plugged into a variac so that the dual-output voltage levels are infinitely adjustable by the variac up to about 52 VDC. AC power line isolation is provided by T1. The output voltage capability is typically adequate to functionally test most power amplifiers, even those specified for considerably higher rail voltages. (For higher-output voltages, a power transformer with higher secondary voltages can be incorporated in place of T1.) The dual positive current-limited outputs can be paralleled to double the available current capability; the same holds true for the dual negative current-limited outputs. After it has been determined that the amplifier under test is functioning properly, the amplifier can be connected to the unlimited outputs for load testing.

The series pass transistors in this power supply design are intended to provide current-limiting action on an intermittent basis only; otherwise they will overheat (R_{THJC} of the series pass transistors is such that even an ideal heatsink cannot keep the junction temperature from rising too high under all possible voltage and current conditions). Since a current-limit action indicates a fault in the amplifier under test, common sense dictates that the power supply will be turned off almost immediately if a current-limit action occurs. I have found this method to be completely adequate for my needs. However, if you want something more elaborate, it is easy and inexpensive to incorporate four optical isolator ICs to monitor the collector-to-emitter voltage drop of the series pass transistors. The outputs of the optoisolators could then be OR-ed to a control relay that would shut down the power supply if a current-limit condition occurred (you would want a few seconds delayed response in this shut-down circuit to facilitate the tolerance of normal surge currents). Another option is to incorporate paralleled series pass transistors. If this power supply design were to be manufactured and sold commercially, an adjustable crowbar output circuit would need to be incorporated to protect the amplifier under test in the event of a power supply component failure. I leave these options to the imagination and ingenuity of my readers.

Every person involved in the building, testing, or analysis of audio power amplifiers will need a substantial variety of dummy loads. Dummy loads can be custom-made by purchasing a variety of power resistors from surplus electronic suppliers. This is probably the least

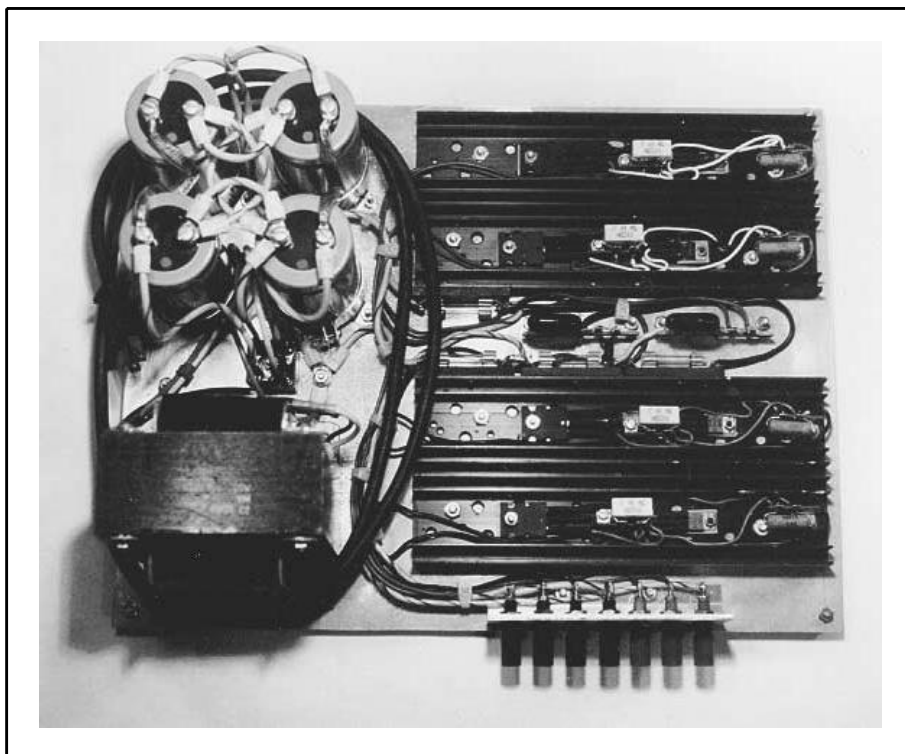

The bench power supply design of Figure 13.1. This power supply can be used for testing the majority of amplifier designs in this book.

expensive method of obtaining a good inventory. Reasonably priced professional audio dummy loads are also sold by many electronic dealerships. Your individual needs in this regard will naturally depend upon your goals. If you intend to build 1000-watt RMS amplifiers, you will need 1000-watt dummy loads to test them.

Computerized Analysis Equipment

Up until a few years ago, I would have said that a high-quality distortion analyzer is of paramount importance to anyone who is serious about audio electronics. With the advent of modern DSP methods, I now consider distortion analyzers to be impractical when compared to the new generation of computerized audio analysis software-hardware combinations. For those of you who are unfamiliar with the basics of these systems, the following is a brief fundamental description.

A complete audio analysis package will consist of one or more low-distortion sound cards, one or more input cards, appropriate signal conditioning systems with interface cabling, and a specialized software program for data collection, display, and analysis functions. The user must have a compatible computer system for the sound and input cards to interface with. Once implemented, the power, as well as accuracy, of such systems is nothing short of extraordinary. Harmonic distortion, intermodulation distortion, Fourier analysis, spectrum analysis, phase relationships, bandwidth, AC analysis, and noise measurement data can be accumulated, stored, analyzed, compared, printed, graphed, and examined in any number of combined relationships. In addition, the overall accuracy of such systems is far improved over the dedicated distortion analyzers of the past.

The top of the line of computerized audio analysis systems is, without doubt, the *Audio Precision System One*, sold and distributed by Thurlby Thandar Instruments of the United Kingdom (telephone 01480-412-451, fax 01480-450-409). This system has set the performance standards for all other systems, and it was also one of the first of its generation, having been developed more than 10 years ago. Don't expect to buy one of these systems with this week's milk money allowance, however. Prices are around \$7000 to \$8000!

For those of us with limited financial resources, excellent audio analysis systems are available through Pioneer Hill Software, 24460 Mason Road Northwest, Poulsbo, WA 98370 (telephone 360-697-3472, fax 360-697-7717). They are the distributors for the *Spectra Plus* signal processing software. Individual needs, of course, will vary, but for a complete hardware-software package, it is reasonable to expect the final cost to come out somewhere between \$600 and \$1000. These packages are versatile, allowing the flexibility of putting together the ideal system according to the individual's needs.

There are many other audio analysis programs available, with a variety of associated hardware and software options. If you're interested in obtaining further information on selection, availability, and pricing of a wide range of such systems, the best place to start is the Audio Amateur Corp., Post Office Box 876, Peterborough, NH 03458-0876 (telephone 603-924-9464, fax 603-924-9467). Audio Amateur Corp. is a great general resource for almost any audiophile need.

Computerized Design and Layout Programs

Powerful software tools for the audiophile do not end with analysis programs. While analysis programs allow you to analyze how well an audio amplifier is performing, the new generation of design and layout programs are extraordinarily powerful at helping you to design and construct the amplifier in the first place.

Design programs provide the user with an almost infinite software parts inventory that can be dragged down from a parts bin and put together to construct circuit diagrams. Circuit diagrams can be extremely complex, with capabilities of going to subcircuits if the video screen becomes too populated. Every part is modeled in a *simulation engine* (*SPICE* versions being the most common) so that the entire circuit can be tested on both functional and analysis levels. If the circuit operation is not exactly to your liking, you can change out parts or vary parts' values until the optimum performance is obtained. Once completed, the finished circuit can then be stored on disk and/or hard-copied with any type of graphics printer.

A completed circuit design can also be exported to a layout program, providing very sophisticated PC board design tools, including exhaustive error detection, autorouting, force vectors, and capabilities of up to 32 routing layers! The finished PC boards can include copper lettering, top and bottom silk-screening, and a host of options for almost any prototype or manufacturing application. Completed circuit and PCB designs can be manipulated and electronically mailed like other computer information, opening new worlds between long-distance hobbyists and professionals alike.

In addition to the speed and convenience of computer simulation from a normal design perspective, circuit simulation provides the user with the power to solve design problems that are impossible to duplicate in the real world. For example, in Chapter 7 I discussed the importance of utilizing low-capacitance transistors for the predriver stage in CF OPS designs. The theory behind this design methodology was proven in *SPICE* simulation by creating predriver transistors without any junction capacitance characteristics. I simply went to the software model for the particular transistor I was using in the test circuit and zeroed the *SPICE* parameters for base-to-emitter junction capacitance. In effect, I emulated a perfect transistor from a base-emitter

capacitance viewpoint. In the real world, transistors without capacitance are a physical impossibility, but in virtual design world, they can be commonplace!

Loudspeaker modeling is a field of audio electronics that is currently in its infancy. I foresee a time when every speaker system manufacturer will routinely provide models for all of their products (i.e., the speaker system model, taking in account the crossover network and the physics of the speaker enclosure), providing the capability of testing any amplifier design with every available speaker system. Loudspeaker modeling is already commonplace in the design of speaker enclosures.

If you are not experienced with software circuit design tools, you may be somewhat confused regarding their importance to your particular circumstances. Allow me to try to condense the major benefits into the proverbial nutshell using a real-life hypothetical situation.

Suppose you have a Saturday afternoon free. You happened to receive the latest issue of *Audio Electronics* magazine in today's mail, so you decide to sit down and browse through it. Suddenly, a radically new class A power amplifier design catches your eye, and you begin thinking about how well this design would work with a massive heatsink you've been keeping for no special reason. The magazine design specifies lateral MOSFETs for the OPS, but you have a large scavenged inventory of IRF-640 and IRF-9640 devices. In addition, you happen to be skeptical about the claimed performance of the input stage design. So you go to your computer, call up your electronic design program, and duplicate the amplifier design in software. Depending on the complexity, this may take you 30 minutes to an hour. Next, you run a variety of simulation analysis tests, including AC analysis (for stability testing), Fourier analysis (for THD and spectrum analysis information), and noise. You may decide to test the circuit for stability and performance using a wide variety of load impedances and/or power supply voltages. The input stage design functions much better than you anticipated, so you now substitute your on-hand MOSFETs in place of the lateral MOSFETs specified in the magazine. With a little experimentation, you discover that the design will perform very well with your on-hand inventory, needing only a slight modification in the Vbias circuit. Testing and analysis have taken you approximately 2 hours. You save your design and go out to your son's baseball game.

Later that evening, you're bored with the television programming, and your mind begins to wander back to your amplifier design of the afternoon. You pick up your *Audio Electronics* magazine once more and notice that the PC board design for the amplifier is not physically compatible with the large heatsink in your junk box. In addition, it also occurs to you that the lead orientation of your V-MOSFETs is different than that of L-MOSFETs. You go back to your computer, call up your amplifier design, and export it down into your layout program. About 2 hours later, you have a modified version of the PC board, including artwork changes to accommodate the different output devices and a physical size that you believe will match your heatsink. Since you aren't sure of the physical size, you print out a 1:1 copy of the artwork and lay it down on top of the heatsink to verify that you've gotten all of the dimensions correct. Once satisfied that everything looks good (you don't have to worry about any electrical errors; the program already verified this through the *SPICE* netlist), you save your PC board design and go to bed. Several days later, when you decide to make the amplifier's PC board, you call up your previous artwork design and print out a reflected (bottom-side) image onto a sheet of clear transparency. You lay this down on a presensitized PC board blank, and expose it with a floodlight for about 10 minutes. You then immerse the board in developing solution for a minute or two, remove it, and wash it off in cold water. Finally, the board is etched, cleaned, drilled, stuffed, and mounted to the heatsink. You are now ready to do real-world testing of the amplifier design. This last process took you about 6 hours. (If you had wanted to make two PC boards for a stereo version of the amplifier, the total time investment would only be increased by a small amount.)

The point to this hypothetical story is that any electronics hobbyist, audiophile, or engineer can go from the idea phase to the completion phase in less than 24 hours of total time investment! *SPICE* simulation is very accurate, so you can be reasonably sure that the simulation analysis will be very close to the real-world performance. Thoughtless mistakes in design and construction are almost eliminated (except in situations in which you reverse the rail supply voltages, as I did while testing the MUSAMP1 design of Chapter 11). And the really good news is that personal editions of these sophisticated programs can be purchased for less than \$600! I estimate that I can

save this much money in a year's time since I now blow up most of my output devices in virtual electronics world. This isn't even considering the enormous savings in time and the monetary investment of an exhaustive parts inventory!

The software circuit design system I use is the *Professional Edition of Electronics Workbench*, distributed by Interactive Image Technologies, Ltd., 111 Peter Street, 801, Toronto, Ontario, Canada M5V 2H1 (telephone 416-977-5550, fax 416-977-1818). *Electronics Workbench* has all of the capabilities as detailed in this section (and a great many capabilities that I don't have room to discuss in this book), and it is user friendly, requiring a minimum of time for almost anyone to learn how to use. Comparatively speaking, in the time it took me to understand what the opening screen icons meant in *Windows95*, I was already building and testing circuits with *Electronics Workbench*.

One of the things I appreciate the most about *Electronics Workbench* is the excellent support provided by the people at Interactive Image Technologies. A few of the technical problems associated with the production of this textbook were literally awesome, but I have never felt abandoned or put off by their excellent technical support team. In discussing the *Electronics Workbench* program with other professionals, I have discovered that I am not alone in my high regard for both their product and support. For the serious electronics hobbyist or professional, this program is simply invaluable.

Testing Procedures for Audio Power Amplifiers

The testing of audio power amplifiers can be broken down into two basic categories: evaluation testing for determining the amplifier's actual performance and functional testing to determine if the amplifier actually works. Obviously, functional testing is a requirement on every occasion that an amplifier is serviced or repaired.

Evaluation Testing of Audio Power Amplifiers

At its most basic level, evaluation testing requires that a power amplifier is placed in a real-world operational environment (i.e., outputting power to a realistic speaker load utilizing nominal power supply voltages with setup adjustments already performed) with a low-distortion

sine wave signal generator supplying an input signal and an oscilloscope monitoring the output waveform. This is as far as many hobbyists' equipment and resources will allow them to go. Utilizing a good dual-trace oscilloscope connected to simultaneously monitor both the input and output signal waveforms, a reasonably accurate assessment of the power amplifier's performance can be ascertained. With a little experience and careful attention to accurate comparison of input-output waveforms, distortion levels higher than about 1 percent can be seen in the trace pattern. Reasonably accurate V_{bias} adjustment can be verified by applying a very low level input signal (i.e., so that the output voltage level is only a few volts peak to peak) and observing nonlinearities around the crossover region. A little trial-and-error adjustment of V_{bias} during this process will provide a good feel for where the optimum adjustment point is. Minimum and maximum adjustments of the signal generator frequency will provide an accurate determination of the amplifier's bandwidth.

A basic evaluation, as just described, is good enough for many hobbyists, and unless you are a member of the proverbial golden ear club, the results will probably be satisfactory (especially in the case of many musical instrument amplifiers). To the serious audiophile, however, the previous method is grossly inadequate.

The traditional method of sophisticated amplifier performance evaluation began with a top-quality distortion analyzer (usually an HP-334A model). Distortion analyzers produce a low-distortion sine wave input signal that is applied as the input signal to the amplifier under test. In turn, the amplifier's output signal is applied back to the distortion analyzer, where the fundamental frequency of the input signal is subtracted, leaving only the distortion residuals. The ratio of the distortion residuals to the output signal (measured in decibels or percentages) becomes the traditional THD+N specification (total harmonic distortion plus noise). Distortion residuals can be observed with an oscilloscope, providing an educated guess of the distortion mechanism creating the distortion. For example, if a distortion residual showed a high content of 120-Hz humps, it is a safe bet that the power amplifier under test has a problem with poor PSRR and is exhibiting distortion from power supply ripple. Unfortunately, more complicated distortion mechanisms were sometimes hard to ascertain from a simple visual of the distortion residual.

Through the use of computerized analysis equipment, the accuracy and analysis of distortion mechanisms can be greatly enhanced. A computer sound card generates the low-distortion input signal applied to the amplifier under test. The output signal from the amplifier is then applied back to the computer by means of an input card and its associated signal conditioning system. The computer performs the same fundamental frequency subtraction process as a traditional distortion analyzer, and the software program performs the analytical calculations to arrive at a THD + N specification.

Unlike traditional distortion analyzers, however, the computer analysis system can also run a spectrum analysis, Fourier analysis, and AC analysis in a matter of seconds. The combined examination of these analyses can precisely pinpoint the problematic area in the amplifier's performance, leaving little to guesswork. In addition, there isn't any time wasted in setup procedures for determining different performance characteristics. Bandwidth, phase relationships, distortion characteristics, noise performance, and power output can all be determined without touching another clip lead. After the initial test setup is completed, the only requirement of the operator is to run the computer and change out the speaker loads (if evaluations are preformed on a variety of speaker loads, which is usually the case).

A thorough evaluation by a serious audiophile may require distortion measurements into the realm of four or five digits beyond the decimal point at a variety of different frequency fundamentals. It will include noise, sensitivity, input impedance, bandwidth, damping factor, output power, intermodulation distortion, harmonic distortion,

and AC mains requirements. More detailed evaluations may include slew rate specifications, headroom values, common mode rejection values, voltage gain, phase response, crosstalk, and emissions specifications. With the exception of emissions specifications, all the aforementioned variables can be measured with a computer analysis system or easily measured or calculated with standard electronic test equipment. Emissions specifications (both power line and free-air transmitting)

QUICK TIP

For typical hobbyists constructing conventional power amplifiers (as provided in this textbook) for personal use, radiated emissions should not be a concern. However, if you develop the urge to start experimenting with high-power switching power supplies or 1000-watt class D amplifiers, I suggest you look into it. The MIBs from the FCC really exist, you know!

involve governmental agencies and are best left to professional licensing organizations.

Functional Testing Procedures

I am assuming the reader is familiar with fundamental electronic testing procedures. If not, I highly recommend the following publication:

How to Test Almost Everything Electronic by Delton T. Horn

ISBN 0-8306-4128-9 (hardcover), 0-8306-4127-0 (paperback). Available from McGraw-Hill Inc.

Since such fundamentals as testing transistors, MOSFETs, passive components, diode bridges, transformers, and simple power supplies are assumed to be known, we can dispense with the redundancy of wading through these subjects. In addition, I also assume the reader is familiar with the proper and safe use of standard electronic test equipment (i.e., signal generators, DVMs, oscilloscopes, and so on). (The aforementioned book also provides very good coverage of these areas.) In this section, we will discuss initial functional testing in the unique way that it relates to audio power amplifiers.

In this first hypothetical situation, we will imagine that you have just completed the construction of a complete class B audio power amplifier, including the power supply, enclosure, and all associated hardware. The following procedure can be used for performing the initial functional test:

1. Disconnect the power supply from the amplifier electronics. In many high-quality conventional designs, this can be accomplished by simply removing the rail fuses. In some designs, it may be necessary to disconnect the rail supply wires (going to the amplifier electronics) from the reservoir capacitors.
2. Test the power supply (or supplies, depending on design) for proper operation. Verify that the dual rail voltages are symmetrical in voltage level and opposite in polarity. If any auxiliary power supplies are incorporated into the amplifier design (i.e., for powering protection circuitry, preamplifier stages, equalizers, etc.), they should be tested at this time also. Disconnect AC power, and allow time for the reservoir capacitors to discharge. Measure the voltage

across the reservoir capacitors to make absolutely sure they are discharged before proceeding on with the next step.

3. In performing this step, refer to the wiring diagram in Figure 13.2. Make sure all AC power is off. If the amplifier is a stereo version, replace the rail fuses and/or rail power supply wiring to only one channel of the amplifier. Place a standard 100-watt incandescent light bulb in series with the hot AC mains wire, and connect the AC power cord to the output of a variac. Center all adjustment potentiometers on the amplifier PC board. Connect an oscilloscope to the amplifier's output; do not apply a speaker load at this time. If the amplifier is a stereo version, connect the oscilloscope to the channel that has been reconnected to the power supply. Set the variac to minimum output voltage, and apply power to the variac. Slowly begin increasing the variac output voltage while observing the light bulb and the oscilloscope output. If the light bulb begins to light, you either have a defect in the amplifier or the V_{bias} adjustment is set too high. Turn off the variac power, adjust the V_{bias} potentiometer to a different setting, and repeat the last test procedure. If you cannot find a V_{bias} setting that will keep the light bulb from beginning to light as the variac voltage is increased, the amplifier is defective and should be repaired before continuing. Assuming the light bulb does not light, carefully observe the oscilloscope to ensure that the amplifier does not break into oscillation as the operational power is increased. If the amplifier output remains stable, increase the output of the variac up to nominal AC mains level and measure the DC voltage output of the amplifier. If the amplifier is designed without any type of balance potentiometer, the DC output voltage should be very low (typically 20 mV or lower). If there is a balance potentiometer, adjust it for the lowest possible DC output voltage. If a low DC output voltage can be achieved and everything else looks good, the amplifier is ready for setup adjustment and load testing.

The purpose of the light bulb in the previous step is to limit the current flow to the amplifier in the event of a defective component or assembly error. In most cases, this procedure will protect the amplifier components from destruction until problematic areas can be corrected. Also, it is normal in some amplifier designs for low-level oscillations to appear at the output when the rail voltages are extremely

low. If this is the case, the oscillations will disappear as the rail supply voltages are moderately increased.

As I stated earlier, the test setup illustrated in Figure 13.2 is only applicable to class B amplifiers with conventional raw DC power supplies. Class A amplifiers will draw too much quiescent current, and the light bulb will always light. Many amplifiers with switching power supplies cannot be tested at low AC power line levels; consequently, you should never try to use a variac to test a power amplifier incorporating a switching power supply unless this technique is specifically recommended by the manufacturer.

When initially testing class A amplifier designs, you can follow the same basic procedure as detailed previously, with the exception of omitting the series light bulb. Based on the amplifier design, you should have a rough idea of the expected AC mains current that will be drawn by the amplifier if everything is functioning properly. Apply AC mains power to the amplifier gradually with the variac, carefully monitoring the AC line current. An abnormally high AC line current at low operating voltage is indicative of a problem.

Continuing on to a second hypothetical situation: Suppose you want to functionally test a class B audio power amplifier assembly before constructing a dedicated power supply for it. The following procedure can be followed:

1. You will need a bench power supply capable of supplying the necessary rail voltages and currents to the amplifier under test. The

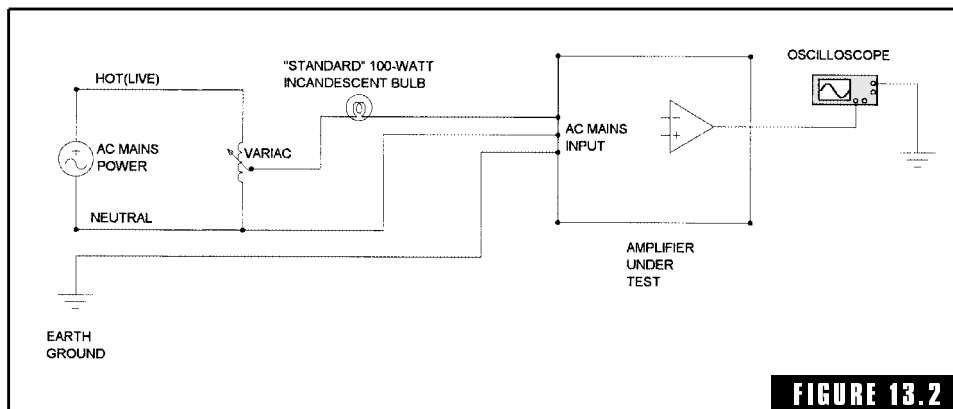

FIGURE 13.2

Initial test set-up for a conventional audio power amplifier.

power supply design of Figure 13.1 (or one similar to it) will perform this function.

2. Connect the bench power supply to the output of a variac. Connect the appropriate current-limited power supply outputs to the amplifier assembly under test. Connect an oscilloscope to the output of the power amplifier assembly.
3. Adjust the variac for minimum output voltage, and apply AC power to the variac. Slowly bring up the variac output voltage while observing the oscilloscope and the variac current meter (or if your variac doesn't have an integral output current meter, you can use a DVM to monitor the variac output current). If the variac output current begins to approach 1 amp, this indicates that one or both of the power supply outputs has approached the current limit. Again, this could be the result of the V_{bias} setting or an amplifier defect. A few trial-and-error adjustments of the V_{bias} potentiometer will isolate the problem. The oscilloscope should also be observed during this power-up procedure. If the amplifier output shows signs of severe instability, the stability problem needs to be corrected before any further testing can be accomplished.
4. If the rail voltages can be brought up to nominal levels without current-limiting or instability problems, the DC output of the amplifier should be measured. If the amplifier design does not incorporate a balance adjustment, the DC output voltage should automatically be very low. If a balance potentiometer is used, it should be adjusted for a very low DC offset (less than 20 mV). If this can be accomplished and everything else looks good, the amplifier assembly can be assumed functional. It will probably not be prudent to perform setup adjustments or load test the amplifier assembly until you install it into an enclosure with its own dedicated power supply.

All high-quality audio power amplifiers utilize an operational amplifier design topology. This means they will be highly immune to power supply variations and voltage levels. Consequently, even if an audio power amplifier assembly is designed to operate from dual 70-volt rail potentials, it will probably function well with the substantially lower DC voltages produced by the power supply design of Figure 13.1.

If the power supply design of Figure 13.1 is utilized to functionally test a class A amplifier assembly, the two current-limited positive outputs can be paralleled together, with the same being done to the two current-limited negative outputs. This will increase the current-limit output to approximately 3 amps per rail supply, which is usually sufficient for most class A designs.

Symptomatic Troubleshooting of Personal Amplifier Projects

In many cases, audio power amplifiers are not simple to troubleshoot. If a problem exists in the amplifier electronics, it will probably manifest itself in one of two ways: The output will be driven to one of the rail potentials, or a number of semiconductor devices will be destroyed through the domino effect.

Some amplifier manufacturers are very conscientious about supplying schematic diagrams of their products showing myriad quiescent voltage levels throughout the entire amplifier circuitry. Unfortunately, these voltage measurements are not very useful in the event of an amplifier failure. This is because a high-quality audio power amplifier is essentially one big feedback loop. Even a relatively minor problem will probably cause almost every internal DC level to deviate to extreme levels, making any attempt to isolate a problem based on voltage levels a thoroughly frustrating affair.

If functional testing indicates a fault in a newly constructed amplifier, the most likely problem is an error in construction. The fault will probably turn out to be a backward diode, a wrong transistor part number, a tiny solder bridge across two very close PC board tracks, or a similar workmanship error. The most important step in the entire troubleshooting process is to perform a very careful visual inspection of the amplifier electronics.

If a visual inspection doesn't reveal any faults, it is wise to do a point-to-point verification of the amplifier electronics using the amplifier's schematic as a reference. For example, beginning with the first semiconductor device Q1, the schematic may illustrate the base lead connecting to the base lead of Q2 and a 1-k Ω resistor. Use a semiconductor data book to determine the base lead of Q1, and visually trace out its connection points on the PC board artwork. (If the amplifier PC board is already mounted in an enclosure, it will probably have to be

removed for this procedure.) If the base lead of Q1 is truly connected to the proper points, and the resistor it connects to is actually a 1-k Ω resistor, perform the same verification with Q1's emitter lead, and so on. Continue this process until you have verified all the connection points of every semiconductor device within the amplifier's electronics. I recognize this to be a tedious methodology, but there just isn't an easier way to find assembly errors in a newly constructed amplifier.

Naturally, there is always a chance that a component is defective—either it was defective when it was supplied by the manufacturer, or it was destroyed in the soldering process or during functional testing. If a point-to-point examination indicates that the assembly is correct, the electronic components will have to be functionally tested. It is more probable that one, or more, of the semiconductor devices is defective, so they should be tested first. An in-circuit semiconductor tester (such as the Sencore Super Cricket) is the easiest way to accomplish this. However, in-circuit testers cannot test all semiconductor devices contained within direct-coupled amplifier circuitry (the interlead impedance will be too low in some cases), so it will probably be necessary to desolder one or more of the leads when testing some transistors.

If all of the semiconductor devices test out well, the only other possibility is a defect in one or more of the passive devices (this is what is commonly referred to as a *dog* in servicing circles). The obvious solution is to check them out one at a time.

If it's any consolation, I have been designing and working on audio power amplifiers for approximately 22 years, but about 6 months ago, I ran across a dog that took me a whole day to troubleshoot. Experience has taught me that frustration is sometimes the greatest enemy in accomplishing a personal goal. If you run into a really tough problem, it is sometimes wise to get away from it, have a cup of coffee, watch a good movie, and relax! Often, the solution will become obvious if you give your mind a chance to clear.

Symptomatic Troubleshooting of Commercially Manufactured Amplifiers

Almost everyone involved with audio power amplifiers will find themselves in a position where they are called on to repair a commercially manufactured amplifier. This could occur on a professional level or could be at the request of family or friends. While most general

troubleshooting methods are the same as for personally constructed amplifier projects, there are a few differences to keep in mind.

The first, and foremost difference, is that you know the amplifier worked at one time. This fact eliminates any suspicions involving design errors and assembly errors, so it isn't necessary to go through the tedious process of verifying point-to-point connections. However, a careful visual examination and the eventual need to functionally test the semiconductor components will almost certainly be required.

Always remember to ask the owner of the amplifier what the symptoms and circumstances of the failure were. Did the owner accidentally spill a glass of milk on the amplifier just before it failed? Was the amplifier dropped recently? Was there a lightning storm or power failure around the same time as the failure? Is the problem in one or both channels? This type of interrogation can often provide important clues that will aid in the entire troubleshooting process.

Note: On one occasion, I repaired the same amplifier three times for a friend before I discovered he was oiling the amplifier after each use. I couldn't understand how all that dirt and oil were getting into the amplifier, but I didn't think to ask him about it until the third repair!

If possible, it is always wise to contact the manufacturer to obtain all the technical service information on any commercial amplifier that you intend to repair. This will often save many wasted hours of tracing wires and trying to comprehend the design topology. In many cases, this information will include detailed troubleshooting procedures and generic cross references for their in-house component identification numbers.

The repair of a manufactured power amplifier should start with a careful visual examination. Power amplifiers will often leave an obvious footprint of the failure, manifested in the form of burned resistors, blown fuses, vaporized PC board track, blown-up capacitors, and even small holes in the tops of TO-3 packages caused by the disintegration of the internal silicon wafer. In many instances, the failure footprint will lead you directly to the problem(s). Remember that a semiconductor failure can result in the failure of other semiconductor devices within the direct-coupled environment. Don't be too quick to replace one defective device and assume the problem has been solved!

If a visual examination doesn't reveal any obvious problems, the next logical step is to take a few resistance measurements to circuit common. The critical points to check will be the rail supply outputs of the reservoir capacitors and the rail supply connections to the OPS. It may be prudent to take other resistance measurements depending on the design of the amplifier. If any of the critical points show a low resistance to circuit common, don't attempt to power up the amplifier until the source of the low resistance is located and repaired.

By far, the most common problem with audio power amplifiers is OPS failure, due to one or more defective output devices. It is a good practice to functionally test the output devices before applying any operational power to the amplifier, regardless of the outcome of the visual inspection or resistance measurements.

If the visual examination, resistance measurements, and output device tests all appear to look good, you can proceed with the initial functional testing procedure as detailed earlier. Functional testing should isolate the problem to either the power supply or the amplifier electronics. If the problem is in the amplifier electronics, a more focused visual examination of the PC board may locate hard-to-see defects, such as a cracked resistor, a cracked PC board track, or a broken component lead. (If you do a lot of work on audio power amplifiers, you will find a magnifying light invaluable.) If visual defects cannot be found, functional testing of the semiconductor devices will be required.

Commercially manufactured audio power amplifiers incorporating switching power supplies present several unique problems if troubleshooting is required. First, some switching regulator designs will not function properly unless they are minimally loaded. Therefore, if you disconnect the amplifier electronics to test the power supply, the power supply may appear defective. Second, if you leave the amplifier electronics connected to the power supply during initial testing, a fault in the amplifier electronics could cause severe damage. Or if there is a fault in the power supply, it could appear that both the power supply and the amplifier are defective.

The best way to troubleshoot switching power supplies is to obtain the manufacturer's service data and abide by the service instructions they contain. Unless a service procedure is specifically recommended in the manufacturer's service information, I do not recommend any attempt on the part of the amateur to diagnose or service switching

power supplies. This is a job for specialists, in some cases requiring very specialized equipment. However, there are methods of troubleshooting the amplifier circuitry, if the amplifier circuitry is of a conventional nature.

One approach is to assume the switching power supply is functional and direct all of your attention to the amplifier circuitry, performing all the conventional test procedures as detailed earlier. As a general rule, the amplifier circuitry is more likely to fail than the switching power supply, so the chances are good that the problem can be isolated with this method. Another approach is to remove the amplifier assembly (or assemblies) and perform functional testing with an external power supply (such as the design illustrated in Figure 13.1). Unfortunately, with the mechanical design of some amplifiers, this procedure could be rather difficult.

One of the largest manufacturers of audio amplifiers with switching power supplies does not incorporate any overcurrent protection in the power supply design. Therefore, if one of the BJT output devices fails (BJT output devices almost always fail by developing a short-circuit from the collector to emitter), the MOSFETs in the switching power supply will automatically be destroyed. Needless to say, this is a very poor design approach. This same manufacturer now offers a conventional power supply retrofit for their amplifiers, which is what they should have incorporated in the first place. If you are working on an amplifier with a switching power supply and you discover a major defect in the amplifier electronics, don't automatically assume the switching power supply is good.

Setup Procedures for Audio Power Amplifiers

Many audio power amplifier designs incorporate a balance adjustment (potentiometer) for setting the quiescent output rail voltage at 0 volts. Some amplifier designs utilize two balance adjustments: one for establishing a DC balance of a differential VA stage and the second used to set the DC level at the output rail to 0 volts. If balance adjustments are required, they should be performed as the first step of the setup procedure.

Balance adjustments are usually straightforward and simple. Nominal operational power is applied to the amplifier that is being

adjusted, and the adjustment potentiometer is varied until the proper balance is obtained. The amplifier should not have any type of speaker load connected during this procedure. If the amplifier design incorporates two balance adjustments (such as the amplifier design of Figure 11.2), the adjustments will probably be interactive with each other, requiring repeated adjustments until both balance parameters have been met simultaneously.

For optimum distortion performance, the most critical variable will be the V_{bias} adjustment (in class B designs only). The recommended procedure for this is as follows:

1. Connect a nominal dummy load to the output of the amplifier.
2. Using a distortion analyzer or computerized analysis system, apply a low-distortion signal voltage to the amplifier's input, and monitor the distortion level at the amplifier's output.
3. Adjust the V_{bias} for the lowest THD+N measurement.
4. Allow time for the amplifier's OPS heatsink to reach nominal operating temperature.
5. Readjust the V_{bias} potentiometer for the lowest THD+N measurement.

If you do not have a distortion analyzer or computerized analysis system available for the V_{bias} adjustment, the following method will get you pretty close to optimum performance:

1. Do not connect any type of speaker load to the amplifier's output.
2. If the OPS is an EF design, adjust the V_{bias} potentiometer so that approximately 2.88 volts is developed across the Q_{bias} transistor.
3. If the OPS is a CF design, adjust the V_{bias} potentiometer so that approximately 1.29 volts is developed across the Q_{bias} transistor. This is also applicable to hybrid MOSFET OPS designs.
4. If the OPS is an SF lateral MOSFET design, adjust the V_{bias} potentiometer to drop approximately 0.85 volts. If V-MOSFETs (that is, D-MOS, HEXFET, etc.) are utilized for output devices, the V_{bias} potentiometer should be adjusted for approximately 50 mA of drain current per device. Drain current can be calculated by measuring

the voltage drop across the output devices' source resistors (that is, RE resistors). For example, a source resistance of 0.33 ohms would drop about 16.5 mV if the drain current were 50 mA.

5. Regardless of the OPS design, allow time for the amplifier's OPS heatsink to warm up.
6. Readjust the Vbias potentiometer to the appropriate voltage level, depending on the OPS design.

Another method of adjusting Vbias without a distortion analyzer or computerized analysis system is illustrated in Figure 13.3. With this method, Vbias is adjusted according to Vq, which is the sum of the quiescent voltage drops across the output RE resistors. Figure 13.3 is rather self-explanatory. In the case of EF OPS designs, Vbias is adjusted for a Vq of 47 mV. Vq is set to 8 mV in CF OPS designs, and 33 mV in MOSFET (L-MOS or V-MOS) OPS designs. This method is actually more accurate than simply setting the Qbias voltage to an estimated value, and it is preferred over the previous methodology for OPSs incorporating MOSFET output devices.

Load Testing of Audio Power Amplifiers

Load testing of audio power amplifiers is performed for various reasons. It is a safe method of verifying that the OPS overload circuitry is functioning according to expectations. Load testing under worst-case conditions (i.e., a continuous sine wave output signal at 64 percent below clipping feeding a low-impedance speaker load) is a means of testing the amplifier's thermal integrity. It is sometimes desirable to purposefully create a thermal overload for the purpose of testing the thermal overload protection circuitry.

A major purpose of load testing is to evaluate the amplifier's performance. Even though dummy loads are not a good representation of an actual reactive speaker load, virtually all audio power amplifiers are performance analyzed utilizing dummy loads so that the performance of one amplifier can be compared to another. In other words, load testing establishes a baseline that can be used for comparative analysis.

A typical amplifier will be tested for THD+N and bandwidth utilizing both 8- and 4-ohm loads. Other amplifier performance variables

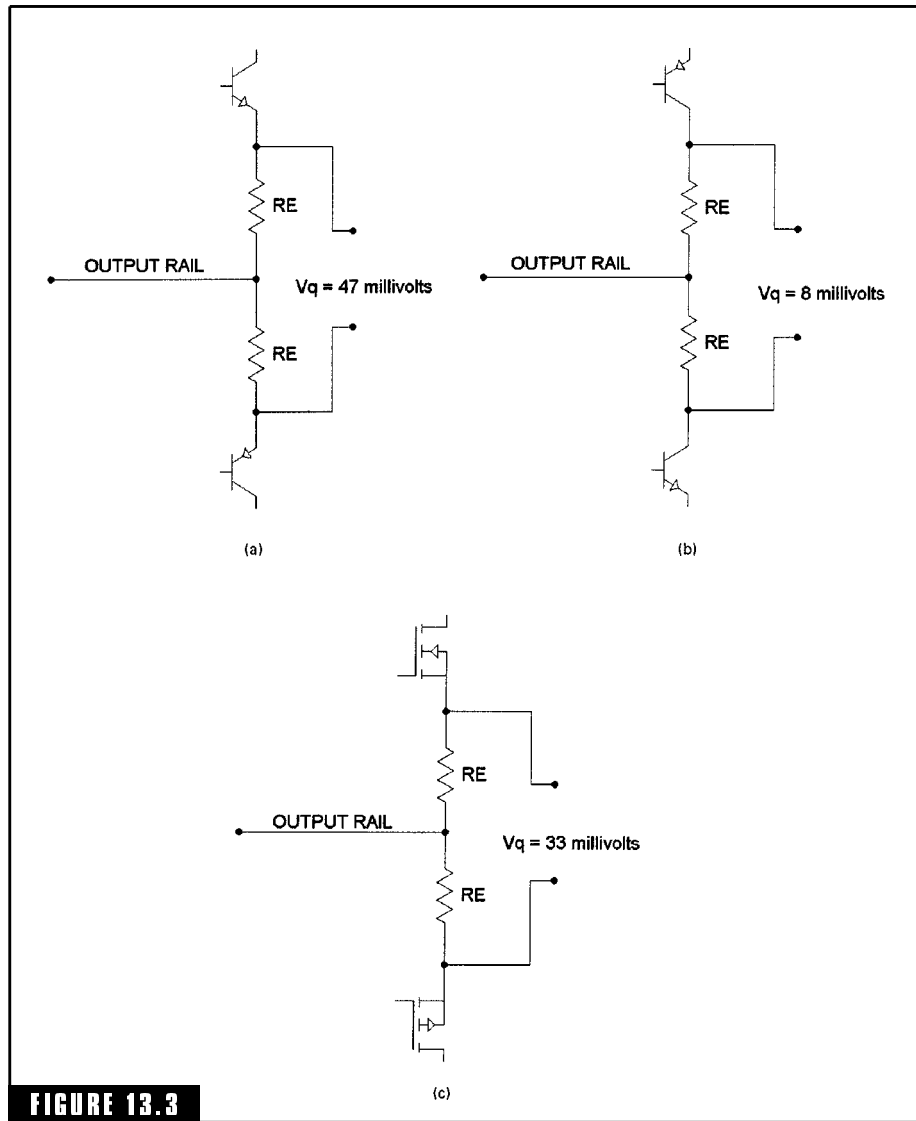

FIGURE 13.3 Adjustment of V_{bias} according to V_q measurement.

may also be tested under loaded conditions, such as slew rate, transient response (i.e., square-wave analysis), stability tests using a variety of reactive loads, and ringing tests (which are completely useless).

Most of the amplifier designs in this textbook have OPS protection circuits designed to activate when the speaker load impedance drops below approximately 2.5 ohms. The safe method of testing the

OPS overload protection is to connect a 2-ohm dummy load to the output of the amplifier. Apply a continuous sine wave input signal to the amplifier, and slowly increase the output voltage level while observing the waveform with an oscilloscope. At some voltage level prior to maximum output, the protection circuits should activate, clipping the output waveform in a very obvious and symmetrical fashion. In some cases, depending on the power supply design, the power supply droop may be prominent enough to allow full available output voltage swing under 2-ohm loading (this is more likely to occur in power supply designs that were derated to about 70 percent of continuous sine wave testing capabilities). If this is the case, reduce the resistance of the dummy load to 1.5 ohms for testing of the OPS overload protection circuitry.

There are a few precautions involved with load testing power amplifiers. In performing bandwidth tests and square wave analyses, remember that the series resistor in the Zobel network is going to dissipate, increasing power at higher frequencies. For example, if you load-tested a conventional audio power amplifier for a significant period of time at full output using a 20-kHz input signal, you are almost certain to burn up the resistor in the Zobel network. The same type of precaution holds true if you incorporate a damping resistor across the output inductor of the amplifier. At high frequencies, the inductor's impedance will rise, forcing an increasing power dissipation of the damping resistor.

Some of the amplifier designs in this textbook incorporate catching diodes; others do not. If you are going to experimentally load-test any audio power amplifier utilizing unrealistic inductive reactance loading (as many audiophiles often do), always install catching diodes for such testing. From a design perspective, there isn't any good reason not to permanently incorporate catching diodes in every audio power amplifier design.

This page intentionally left blank.

Audio Power Amplifier Terminology

The following terms and definitions are commonly used in the field of audio power amplifier design and construction. Not all of these terms will be found within the context of this textbook, since I have kept the variety of synonymous terms to a minimum for ease of understanding. However, the chances are that you will run across many of these terms and buzz words in other audio electronics books and magazines. I felt it would be helpful to include them here.

absolute phase The maintenance of the exact phase relationship between the input signal and output signal of an audio amplifier (or other audio system).

absolute value The numerical value of a number without regard to sign (neither + or -). Absolute values are used in certain electronic equations and graphs in situations where polarity is of no concern. For example, when calculating the pulsating DC output of a bridge rectifier, the polarity of the AC input is of no importance because the bridge rectifier will convert the AC input to a single polarity DC output. However, the absolute value of the AC input will determine the rectified DC amplitude at the output of the bridge.

- AC coupling** A coupling arrangement that will not pass direct current or a DC component of a signal. The most common AC coupling devices are capacitors and transformers.
- AC mains** Often a synonym for *AC power* or *mains power*. It refers to the public AC power line or supply.
- active device (active component)** Any electronic device capable of providing power gain (i.e., voltage and current gain). Examples of active components used throughout this textbook are bipolar junction transistors (BJTs), junction field-effect transistors (JFETs), metal-oxide semiconductor field-effect transistors (MOSFETs), vacuum tubes (*valves* in British terminology), and operational amplifiers (*op-amps*).
- active loading** The technique of replacing a passive load (such as a resistor) with an active load (such as a BJT constant current source) to improve the gain and linearity of a transistor (or other active device) stage.
- airpath** The path of cooling air around a heatsink surface.
- AM** Amplitude modulated. The effect of two or more signals being combined in a nonlinear circuit so that upper and lower sidebands are produced. In audio terminology, amplitude modulation is the result of intermodulation distortion.
- amp** Colloquial abbreviation for *amplifier*. Not used in this book to avoid confusion with *amp*, as used for the abbreviation of ampere.
- ampere** Basic unit of electrical current flow (i.e., electron flow).
- amplified diode** Also known as a *Vbe multiplier*. In audio power amplifier terminology, a specialized circuit used to provide linear bias to an output stage for the purpose of reducing crossover distortion.
- amplify** To increase in size; make bigger.
- amplitude** The magnitude of a varying quantity. Can be used in terms of *steady-state* (i.e., quiescent) or instantaneous units of measurement.
- amplitude distortion** Also called *large-signal distortion* or *large-signal nonlinearity* (LSN). A type of distortion that begins at, or relates to, a specific amplitude or level. In the context of audio power amplifiers, this usually relates to the beta-droop effect, which occurs in the output stage.
- analog** An electrical variable capable of continuous variation, or in possession of an infinite number of states. Normally used in contrast to *digital variables*, which can function only within

the confines of two states, or a specific number of rigidly designated steps. All audio program material is analog, or converted to analog during reproduction.

antisurge A type of fuse that can withstand momentary surge currents that occur during power-up of electrical equipment. Typically called *slow-blow fuses*.

asymmetric (1) A circuit topology that is not symmetrical in terms of component physics. (2) A nonsymmetrical quality of a complex waveform, such that the long-term absolute sum of its positive cycles does not equal the long-term absolute sum of its negative cycles.

audiophile An enthusiast whose hobby, dedication, and appreciation are aimed toward the quality of sound.

audio signal generator An instrument designed to produce pure AC (sine wave) signals for testing purposes. Most audio signal generators have frequency ranges far above and below the audio range, and many have selectable square wave outputs with the equivalent fundamental frequency range.

autonull A circuit incorporating sufficient feedback to cancel out, or nullify, unwanted DC offset voltages. In the context of audio power amplifiers, this usually refers to global negative feedback of sufficient quantity to nullify (zero out) any DC voltage occurring at the input stage. *DC autonulling* is a method of automatically nullifying the DC offset voltage at the output of an audio power amplifier, typically using a DC servo. See *servo*.

auxiliary power supply In the context of audio power amplifiers, a power supply (usually of a lower DC voltage than the DC supply rails) used to provide operational power to various auxiliary circuits (i.e., relay circuits, DC offset protection, etc.).

A weighting A filtering process used in testing. Emphasis is placed on 3.5 kHz (the most sensitive area of human hearing). Used in evaluating distortion and SPL specifications.

back EMF (1) Also called *reverse EMF* and *inductive kickback*. The bothersome or potentially damaging effect of a high-voltage spike being produced in an inductor when its electromagnetic field collapses too rapidly. The rapid field collapse is usually the result of an abrupt switch-off of inductor current flow. (2) The characteristic of an inductor that opposes a change in current flow.

- backtalk** The undesirable condition of one audio system leaking, or feeding, an unwanted signal into another audio system. This condition is similar to *crosstalk*, but differs in the respect that crosstalk occurs internally within only one audio system.
- Baker clamp diode(s)** Diodes installed reverse-biased from the DC supply rails to the output rails of an audio power amplifier. Their purpose is to protect against inductive kickback voltages (i.e., back-EMF). Intrinsic Baker clamp diodes are incorporated into some modern MOSFET devices. Baker clamp diodes are also known as *flyback* and *catching diodes*.
- balance** (1) The comparable sonic-level adjustment between various audio channels. In stereo systems, the control adjustment determining the ratio of output amplitude between the right and left channels. (2) The matching of components and component variables (i.e., voltage, impedance, current) in an electronic circuit.
- band-gap reference** References, or specifications, related to specific points within a total bandwidth. For example, a chart illustrating THD at 100 Hz, 1 kHz, and 10 kHz would be a *band-gap reference* (i.e., there are gaps between the frequency points).
- bandwidth** The range of frequencies that has been specified as performance limits for a component, circuit, or filter. Defined as between the -3 dB (half-power) points at the high-pass and low-pass ends of the frequency response. In high-performance audio power amplifiers, these limits will range from about 3 Hz to at least 50 kHz.
- Belcher test** An audio purity test designed by Dr. Alan Belcher. It utilizes a pseudo-random noise signal to simulate musical (complex) input signals. Since various aspects of the simulated music are known, a comparison of input and output signals reveals an analysis of the way the amplifier processes complex signals of any kind.
- beta** The current gain variable of a BJT.
- bi-amping** A system whereby the music signal is filtered through an active crossover, separated into narrow frequency bands (high-frequency, mid-frequency, low-frequency, subsonic, etc.), and individual audio power amplifiers are utilized to amplify each frequency band. In this way, passive crossovers are eliminated in the speaker system(s), with the power amplifiers driving the individual speaker components directly.
- bias** In the context of audio amplifiers, a set of voltage and current conditions that establish a desired quiescent circuit operation.

- biphase** Two phase. Usually associated with the output of a coupling transformer used to drive a push-pull output stage.
- bipolar** Essentially a synonym for *bidirectional*.
- bipolar junction transistor (BJT)** The technical name for the common transistor. See *transistor*.
- BJT gain droop (or BJT droop)** A large-signal nonlinearity mechanism inherent to all BJTs used as output devices in power amplifiers. It is a result of H_{fe} variations during peak periods of current flow (i.e., a cyclic distortion).
- bleeder** A resistor used to slowly discharge a filter capacitor after the mains power has been shut off. The use of bleeder resistors in power supply design is primarily a safety precaution.
- bootstrapping** A technique for lifting a generator circuit above ground by a voltage value derived from its own output signal. In the context of modern audio power amplifiers, the technique of bootstrapping is used more often for the purpose of impedance modification.
- breakdown** Loss of the nonconductive properties of an insulator. In semiconductor terminology, a destructive conduction of current and loss of control usually associated with exceeding the maximum voltage, current, or temperature ratings of the device.
- breakthrough signal** A general term to describe any type of undesirable interference signal (from any source) that gets into and contaminates an audio signal path.
- bridge mode** A connection mode utilizing two audio power amplifiers, with each amplifier being 180 degrees out of phase from the other. A speaker is connected across the high sides (i.e., the terminals connected to the output rails) of each amplifier, greatly increasing the power output (to the speaker) over that which could be obtained with a single power amplifier. Amplifiers connected in a bridge mode are said to be *bridged*.
- bridge rectifier** Either a discrete or modularized form of four solid-state diodes, dedicated to the rectification of AC (usually AC mains power).
- buffer** An impedance matching circuit. Typically, a good buffer will have very high input impedance with very low output impedance.
- cascade** In general usage, this term describes the technique of arranging two or more circuit stages in a series fashion, wherein the output of a previous stage supplies the input to the succeeding stage. Less commonly, the term is used to describe the *totem pole*

configuration of output devices utilized in some high-power audio amplifier designs.

- cascode** A method wherein a common-base transistor stage is used as a collector load for a common-emitter transistor; a technique often used to increase gain, linearity, and reduce Early effect of a common-emitter stage. Although the method is defined using BJTs as an example, the same technique can be accomplished with FETs and vacuum tubes.
- catching diodes** See *Baker clamp diodes*.
- cathode** (1) The negative end of a conducting diode or LED. (2) Positive end of a zener diode in active regulation (i.e., while conducting in the zener region). (3) The electron emitter of a vacuum tube.
- center-tap** The midpoint of a transformer winding. Can also apply to the midpoint of various types of balanced circuits.
- channel separation** A stereo (or multichannel) audio specification, usually expressed in negative decibels, defining the signal isolation from one channel to another. The opposite of *crosstalk*.
- choke** A single-coil inductor.
- class A** A type of output stage biased so that all of the output devices remain in their active region at all times.
- class A-B** A type of output stage biased so that each output device (there must be at least two) will conduct, or remain active, in excess of 180 degrees of the AC cycle. Essentially the same as a class B but overbiased to some extent.
- class B** A type of output stage biased so that each output device (there must be at least two) will only conduct for one-half of the AC cycle (approximately 180 degrees). The output devices will always be driven from a linear source, facilitating a summation through the load that will be an almost identical reproduction of the full 360-degree AC signal. Class B is by far the most common type of output configuration used in audio power amplifiers.
- class C** Used only in *radio frequency* (RF) amplifiers.
- class D** The class designation applied to *pulse-width modulated* (PWM) audio amplifiers.
- class G** The class designation applied to modified class A-B or class B output stages that incorporate multiple power supply rail voltages. During periods of low power demand, the output stage will utilize the lower voltage power supply rails. During periods

of increased power demand, the output stage will automatically switch (via commutating diodes) to a higher voltage power supply rail. The primary advantage is increased efficiency.

class H The class designation applied to modified class A-B or class B output stages that incorporate variable voltage power supply rails. The power supply rails automatically increase in voltage level as output power demand increases. As with class G, the primary advantage is increased efficiency.

class S A method of using a class A stage with very limited current capability, interfaced to a class B stage to make the load appear as a higher impedance, which is within the class A amplifier's drive capability.

clip The condition that occurs when an amplifier stage is driven to the point where it cannot remain in its active region. When clipping occurs, the output signal will flatten out at the peaks, as though they had been clipped off with a pair a scissors.

coil An inductor or choke.

coloration A metaphorical term used to describe some aberration, or distortion, occurring in the original audio material. Audiophiles usually associate this term with the insertion of artificially introduced harmonics.

common emitter A basic BJT circuit configuration; the input is applied to the base, the output is taken from the collector, and the emitter is common to both input and output signals.

common mode A signal that is common in waveform and phase superimposed on multiple conductors. Typically, common mode signals are undesirable garbage signals originating from stray EMI and RFI fields.

common mode distortion The type of distortion caused by common mode stress. See *common mode stress*.

common mode rejection The ability of a circuit to cancel out, or reject, common mode signals. Usually expressed as a ratio in decibels. Can also be expressed in terms of a literal ratio (e.g., 10,000 to 1), in which case it is referred to as the *common mode rejection ratio*.

common mode stress A somewhat conjectural term describing a condition that may occur at the input stage of audio power amplifier designs incorporating high negative feedback. This would only take place if the common mode voltage of the input signal and

negative feedback signal exceeded the V_{th} (threshold voltage) of the input transistors.

comparator A circuit or device that monitors two or more variables and provides an algebraic summation of their values, or provides a logic output if the variables exceed a designated limit or condition.

compensation In the context of audio power amplifiers, it is the tailoring of the amplifier's open-loop gain and phase characteristics so that the amplifier is dependably stable when the global feedback loop is closed.

complementary Equal but opposite (conjugate devices). Matched set of semiconductor devices (that is, BJTs, MOSFETs, JFETs) of opposite polarity.

complementary feedback pair An audio power amplifier output configuration (sometimes called a *Sziklai pair*, after the inventor). For half of the complementary topology, a low power *nnp* BJT is connected to a high power *pnnp* BJT. The collector of the *nnp* is connected to the base of the *pnnp*; the emitter of the *nnp* is connected to the collector of the *pnnp*. BJT polarities are reversed for the opposite side of the complementary configuration.

compression A type of dynamic gain reduction. As signal level is increased, gain is proportionally decreased, maintaining a constant output signal level. In the context of audio power amplifiers, compression circuits are typically inactive until maximum output levels are reached. Consequently, the compression circuit(s) activate and dynamically control the amplifier gain as a method of eliminating clipping.

conduction angle The polar angle of conduction for a specified output device. For example, the conduction angle for a complementary BJT operating in class B mode would be approximately 180 degrees (i.e., the BJT would conduct for approximately half of the full waveform, or 180 degrees).

consonant Musically pleasing.

constant current source An active circuit configuration that provides a regulated preset electrical current. Typically used in differential amplifier circuits.

convection In the context of audio amplifiers, the type of heatsink cooling afforded by natural air movement.

- cross conduction** A destructive condition in audio power amplifier output stages wherein two complementary devices are conducting substantial currents at the same instant in time.
- crossover** Speaker system frequency divider and routing network. Typically a passive network that routes the high frequencies to the tweeter, midrange frequencies to the midrange speaker, low frequencies to the bass driver, and so on.
- crossover area** The conduction area of a complementary output stage wherein both complementary devices are close to their cut-off points. The transitional area of conduction in complementary devices (i.e., the point at which one device turns on as the other device is turning off).
- crossover distortion** Distortion occurring in the crossover area caused by nonlinearities inherent when one output device turns off as the other output device is turning on. Crossover distortion is greatly reduced by applying a slight forward bias to the output devices.
- crosstalk** Leakage signals from one channel to another in a multichannel audio system.
- crowbar protection** A risky, but simple, method used by some audio power amplifier manufacturers to provide DC speaker protection. A triac is used to monitor the amplifier's output. If sustained DC occurs, the triac will fire and short-circuit the amplifier's output rail to ground. Obviously, *only* amplifiers with short-circuit protection can incorporate a crowbar circuit.
- current capability** In the context of audio power amplifiers, the maximum amperes available from the output of a power amplifier.
- current draw** The amount of current utilized from the AC mains.
- current dumping** An adaptation of the basic class S operating mode. A class A amplifier directly drives the speaker load until the output current approaches a predetermined limit. At this point, class B dumper transistors begin to provide (or dump) additional drive current to the load as required. See *class S*.
- current feedback** A feedback system where electrical current is the sensed variable instead of voltage. In the context of audio power amplifiers, current feedback is almost always used in short-circuit protection circuits.

current mirror Any electronic circuit or device that copies a current at a specified ratio. In audio power amplifiers, current mirrors are most often incorporated as collector loads for a pair of differential transistors making up the input stage. In this application, current mirrors force a current balance through both legs of the differential pair, greatly reducing second-order harmonic distortion within the input stage.

current source See *constant current source*.

damping control Virtually extinct in modern audio power amplifiers, damping control provided a method for the user to vary the damping factor by means of variable feedback systems. Damping control was often found in older vacuum tube audio amplifiers.

damping factor The ratio of the output impedance of a power amplifier output stage and the impedance of a speaker system.

Darlington pair A method of cascading two BJTs so that their beta values multiply. For example, by connecting two transistors with beta specifications of 100 in a Darlington configuration, the resultant beta becomes 10,000.

DC autonulling See *autonull*.

DC balance Usually applied to differential BJT or JFET circuits. A quiescent circuit condition when two or more critical voltages are equal.

DC blocking Essentially the same thing as AC coupling. See *AC coupling*.

DC offset In the context of audio power amplifiers, the small, steady-state DC present at the amplifier output. This voltage should be extremely small or virtually nonexistent.

DC servo See *servo*.

DC speaker protection A protection circuit that monitors the output of an audio power amplifier and disconnects the speaker system if any appreciable DC voltage is detected at the output.

decade Any interval of 10.

decibel One-tenth of a bel. A bel is a base 10 logarithm of the ratio of two amounts of power, with one power value being the reference.

derate To use an electronic component below its maximum ratings.

differential amplifier In its simplest form, a two-transistor circuit that shares a common emitter load or current source. If the output is taken between the transistor collectors, a differential amplifier will provide high common mode rejection. (Differential amplifiers are also constructed from JFETs and MOSFETs.) However, in

- the context of audio power amplifiers, common mode rejection is typically of minor concern. Their common use in audio power amplifiers is due to the elegant way they fit into the Lin topology.
- direct coupled** Circuits or stages that do not utilize capacitors or transformers for the transference of signals.
- discrete** A general term used to describe circuitry that does not contain integrated circuits. In other words, circuits constructed from individual resistors, diodes, transistors, and so on.
- dissipation** The amount of waste energy disposed of in the form of heat.
- distortion** In audio technology, the term refers to any deviation, modification, or corruption to the original audio program material, with the exception of amplification.
- drain** One of the three main terminals of a JFET or MOSFET.
- driver** (1) One of multiple acoustic transducers (speakers) within a speaker system. (2) One of the multiple high-current active devices located in an audio power amplifier.
- dummy load** A testing load that looks like a speaker system to a power amplifier but does not produce any sound. Most dummy loads are simple 8- or 4-ohm noninductive power resistors. Various reactive components may be incorporated into a dummy load to more closely simulate the real-world reactive characteristics of a speaker system.
- dynamic headroom** An attempt to define the short-term, or *burst*, power capabilities of an audio power amplifier. The IHF defines dynamic headroom as the maximum RMS power capability for 20 ms after a 500-ms recovery period. See *headroom*.
- dynamic power rating** The short-term (under 1 second) maximum output power rating of an audio power amplifier.
- dynamic range** The difference between the maximum output level and the noise floor. For all practical purposes, it equals the sum of the signal-to-noise ratio and the maximum headroom.
- dynamic speaker** A type of acoustic transducer (speaker) utilizing a speaker cone, moving voice coil, and stationary magnetic field. The most common type of speaker.
- Early effect** The reduction of the effective base width of a BJT when the width of the collector-base junction is increased by increasing the collector-base voltage. Early effect results in a change of a BJT's signal-handling parameters as internal voltage swings increase

(resulting in increased harmonic distortion). High-quality audio amplifiers avoid Early effect as much as possible by using topologies requiring the minimum internal voltages swings (e.g., cascode stages).

- earth ground** (1) The ultimate reference for all electrical operations. (2) The green or green-yellow conductor in most power cables, intended for connection to earth ground.
- eddy current** A circulating current induced in a conducting material by a varying magnetic field. Eddy currents circulating in the core material of a power transformer represent a loss factor.
- electrostatic coupling** Usually an undesirable phenomenon. Refers to the induction of noise or signals into neighboring conductors or circuitry via an electric field.
- electrostatic shield** (1) A shield incorporated into power transformers to prevent capacitive leakage between primary and secondary windings. (2) Conductive shielding used to protect static sensitive (MOS or CMOS) devices from destructive electrostatic discharges. (3) A safety shield used to protect humans from flashover current.
- electrostatic speaker** A type of loudspeaker that operates on the principle of a variable electrostatic field.
- equal loudness contours** A graph with multiple curves plotting frequency (Hz), sound pressure level (SPL), and loudness (phon) to graphically illustrate the nonlinear response of human hearing.
- feedback** A percentage of an output signal that is applied back to the input. Feedback can be either negative or positive. *Negative feedback* (NFB) is utilized in audio systems for correction and stabilization. It can be applied *globally, locally, or nestedly*. *Positive feedback* is usually undesirable (except in oscillators) and is often referred to as *regenerative feedback*.
- feedforward** An alternative to negative feedback for error correction purposes. The error correction signal is derived in parallel with the amplification process and subtracted from the output.
- fidelity** Faithfulness in reproduction.
- floating** An electrical circuit or variable that is not referenced to ground.
- flushout** The functional name for a resistor placed between the base and emitter junctions of a BJT to aid in the removal of charge carriers. The purpose is to improve the transistor's transient response.

flyback diodes See *Baker clamp diodes*.

frequency distortion Refers to nonuniformities of the frequency response within the frequency range.

frequency range The range of frequencies between the typical -3 -dB (upper- and lower-frequency) roll-off points.

frequency response Often used as a synonym for *frequency range*. (See *frequency range*.) The term applied to relative level or gain variations in respect to frequency.

gain An increase in voltage, current, or power. Sometimes used in conjunction with a “negative” value, in which case it is synonymous with *attenuation*.

germanium The element from which the first commercial transistors were manufactured. Due to the severe disadvantages of germanium BJTs in respect to leakage and temperature sensitivity, virtually all germanium BJTs have been replaced by silicon BJTs.

global feedback In the context of audio power amplifiers, the negative feedback taken from the output stage and applied back to the input stage. In contrast, *local feedback* is negative feedback confined to a single stage.

grid The control element of a vacuum tube.

ground Sometimes used as a synonym for *earth ground*. (See *earth ground*.) More often, it is used to denote the chassis common. Occasionally used to erroneously denote *circuit common*.

ground lift Any method of isolating one common point from another. For example, the isolation of earth ground from circuit common.

ground loop A condition in which two or more system components share a common electrical ground line and unwanted (spurious) voltages are unintentionally induced. Often, the ground circuit formed acts like a short-circuited turn in the presence of power line magnetic fields, causing a substantial current to flow (even though the ground conductor’s DC resistance is very low). Ground loops are a key reason for undesirable hum conditions in audio amplifiers.

group delay A time delay imposed on a specific group of signals.

harmonic An integer product of a fundamental frequency. The term *subharmonic* is descriptive of frequencies that are integer fractions of a fundamental frequency.

- harmonic distortion** Any distortion, or coloration, caused by the artificial generation of harmonics. Usually associated with subtle nonlinearities rather than profound types of distortion, such as clipping.
- headroom** The area, or level, of linear operation between 0 dB and clip.
- heat exchanger** (1) A synonym for *heatsink*. (2) A device used for cooling that incorporates an internal chamber of circulating water or some other form of cooling liquid.
- heatsink** A thermally conductive material used to transfer wasted heat away from a heat-sensitive device or area.
- H field** The magnetic component of an electromagnetic wave.
- hybrid** A manufactured package containing both integrated circuit technology and discrete components. Sometimes the term is used to describe a circuit using a combination of active devices from different electronic families (e.g., a vacuum tube-transistor circuit).
- impedance** Total opposition to current flow. Impedance is the summative effect of frequency-related opposition (*reactance*) and DC opposition (*resistance*).
- impedance matching** The technique of optimizing the output impedance of one device with the input impedance of another device to facilitate the most efficient voltage, current, or power transfer.
- inductance** A characteristic of all coils and transformers. It is the property that opposes a change in current flow by either storing or releasing energy contained within its magnetic field.
- infrasonic** A synonym of *subsonic*. Frequencies below the range of human hearing.
- input impedance** The impedance that exists between the input terminals of a circuit or device when the source (i.e., the output of a previous stage or device) is disconnected.
- inrush current** Synonymous with *surge current*. The transient high current that occurs when the AC mains power is initially applied to an electronic system. Inrush current is a result of the rapid charging of power supply filter capacitors.
- instability** In the context of audio power amplifiers, it is the undesirable tendency for a power amplifier to break into either periodic or continuous oscillation. Instability is often used to describe any kind of intermittent problem or abnormal operation.
- insulated gate bipolar transistor (IGBT)** A relatively new electronic device, the IGBT is a literal cross between a MOSFET and a BJT.

An IGBT exhibits the low drive requirements of a MOSFET together with the low saturation voltage of a BJT. It provides good results and incorporates very easily into the output stages of audio power amplifiers.

intermodulation distortion Distortion caused by beat frequencies created when complex AC signals pass through nonlinearities in an audio power amplifier or other audio circuit or device. Since harmonic distortion is also a result of circuit nonlinearities, intermodulation distortion will usually be somewhat proportional to harmonic distortion.

interstage crosstalk A general term for any kind of signal leakage between stages of audio circuitry.

inverter (1) Any circuit or device that inverts. (2) A converter system that provides AC mains power from 13.8 VDC (automobile battery) or similar conversion function.

inverting A 180-degree phase inversion.

jitter Signal distortion and/or intermittent signal loss due to timing errors. Most often applied to digital audio systems.

Johnson noise See *thermal noise*.

joule Unit of energy. 1 watt = 1 joule per second.

junction The combination point of two different semiconductor materials (that is, *p* and *n* materials). In BJTs, all dissipation heat originates from the junction areas.

large signal A relative classification for circuit analysis. In audio terminology, it usually relates to voltage or current swings above 20 percent of the maximum capability of the device or circuit under analysis.

lateral MOSFET A planar type of MOSFET (in contrast to the V-groove double-diffused MOSFETs commonly referred to as *V-MOSFETs*, *DMOS*, *HEXFETs*, *Vertical DMOS*, or *D-MOSFETs*). Lateral MOSFETs were designed specifically for audio applications and have significant advantages over vertical MOSFETs for audio power amplifier applications.

leakage inductance The residual inductance in a transformer winding when all other windings of the same transformer are short-circuited.

limiter In the context of audio power amplifiers, a high-quality compressor circuit designed to keep the output of a power amplifier from going into hard clipping. The high-frequency components

of a clipped waveform are extremely destructive to HF drivers (i.e., tweeters).

- Lin circuit** The classic three-stage solid-state transformerless topology design that is still the basic foundation of about 99 percent of all audio power amplifiers currently being manufactured.
- linearity** The straightness of a graphical line representative of the transfer function (input versus output) of an active device. The phrase *high linearity* is casually synonymous with *accurate reproduction*.
- line level** In the context of audio terminology, the semistandardized output signal level of preamplifiers and audio program material input devices (i.e., tape decks, FM receivers, CD players, etc.). It is typically about 1 to 2 volts RMS. Virtually all audio power amplifiers are designed to accept line-level signals as inputs.
- listening level** An individual assessment of the optimum SPL for a specific room or audio system, or both.
- load** A very general term applied to any device, component, circuit, or system that receives a useful output. In the context of audio power amplifiers, it represents the speaker system(s) or dummy load(s). See *dummy load*.
- load line** A graphical analysis, usually in reference to an active device, representing resistance (or impedance), voltage, and current excursions. Load lines are typically drawn to determine the optimum quiescent settings for a BJT, JFET, or MOSFET single-stage circuit.
- local feedback** Feedback applied to a single stage or component.
- long-tailed pair** British synonym for a *differential amplifier*. See *differential amplifier*.
- microphony** The phenomenon of mechanical vibration causing electrical noise or distortion. May have some relevance to vacuum tube amplifiers but is essentially nonexistent in solid-state amplifiers.
- midband** The audio frequency range to which the human ear is most sensitive. About 500 Hz to 5 kHz, sometimes defined as centered at 3 kHz.
- Miller capacitance** The intrinsic capacitance appearing between the high-level terminal and control terminal of an active semiconductor device, in other words, between the collector and base leads in a BJT and between the drain and gate leads in an FET. Internal Miller capacitance will vary depending on the voltage applied to the high-level terminal and the gain characteristics of the device.

- Miller integrator** In the context of audio power amplifiers, an essential element of the Lin topology. A Miller integrator is constructed by placing an external capacitor between the base and collector leads of a transistor (or gate and drain leads of an FET).
- monoblock (or “monobloc”)** A single-channel (monaural) audio power amplifier constructed in a dedicated chassis with a dedicated power supply.
- music power** An illegitimate term used for defining the output power of an audio power amplifier. In reality, it is a shrewd way of squaring peak output values rather than RMS values when calculating power, and amounts to nothing more than a marketing gimmick to promote sales.
- muting** The act of disabling the output from an amplifier or other audio system. Automatic muting systems (also called *turn-on delay circuits*) are commonly used with audio power amplifiers to mute the speakers during power on/off cycles. This eliminates the annoying (and potentially destructive) turn-on thumps associated with power-up amplifier stabilization.
- nested feedback** A method of injecting negative feedback from the output stage of an amplifier to each preceding stage, creating multiple NFB loops inside the global NFB loop. The technique has seldom been used in conjunction with audio power amplifiers, but is commonly found in operational amplifier design.
- noninverting** An electronic circuit, stage, or system that maintains the same phase at the output as received at the input.
- nonlinearity** The opposite of linearity. See *linearity*.
- Nyquist oscillation** Oscillation caused by excessive phase shift in a negative-feedback loop resulting in the negative feedback turning to positive feedback and sustaining oscillation.
- offset voltage** Slight variance of an established DC voltage. A general term that can apply to minor voltage variances within any electronic circuit or system.
- on resistance** The DC resistance between an FET’s source and drain leads when fully turned on by an applied voltage between the gate and source leads.
- out-of-phase** (1) Analogous to a phase reversal between two signals (when two signals are 180 degrees apart in phase). (2) A general term to describe any phase differential between two or more AC voltages.

- output impedance** The impedance presented by a source to a load.
- output transformer** In the context of audio power amplifiers, the transformer that couples the amplifier output stage to the speaker system. Seldom used in modern solid-state amplifiers due to the nonlinear reactive response. Virtually always used in vacuum tube amplifiers.
- overall feedback** Synonym for *global feedback*. See *global feedback*.
- overload level** An ill-defined term used to loosely describe the level of an overdriven power amplifier in which the sonic quality is no longer acceptable, somewhere slightly below the hard-clipping level.
- parallel mode** Two or more audio power amplifiers connected together, so that the inputs and outputs are paralleled. A risky method of driving very low impedance speaker systems.
- parasitics** Undesirable stray inductance and capacitance.
- passive components** Electronic components that are not capable of providing power gain (i.e., resistors, capacitors, inductors, diodes, etc.). In contrast, BJTs, FETs, vacuum tubes, and operational amplifiers are active components.
- peak** The highest instantaneous level of an AC signal or waveform.
- peaking out** An AC signal or waveform on the verge of clipping.
- peak limiting** An electronic method of limiting destructively high peak output levels.
- phase** The term used to describe the relative timing position of an AC waveform. One complete cycle of any AC waveform is considered to equal 360 degrees, similar to a full circle. Consequently, the phase relationship of any AC waveform can be compared to the timing of another AC waveform, of the same frequency, in terms of degrees.
- phase linearity** A graphical analysis of the absolute phase deviation of an audio power amplifier. Phase shift is compared between the input and output signals throughout the audio bandwidth.
- phase response** Similar to phase linearity, but defined as a plus or minus degree phase shift throughout the audio bandwidth (i.e., not a graphical analysis).
- phase splitter** An electronic circuit used to extract two AC signals, one the inverted complement of the other, from a single AC signal.
- pi-mode class** See *sliding bias*.

- pink noise** Artificially manufactured noise that averages out to equal energy per octave, or other specified increment. As such, it provides a good pseudo-random imitation of all music.
- polarity** In the context of electrical and electronic circuits, the charge orientation in respect to some common point of reference (either positive or negative). Can also refer to the orientation of one or more analog (audio) signals at a specific stage of processing.
- polycarbonate** A type of capacitor dielectric. Considered good quality.
- polyester** Also known as *Mylar*. A type of capacitor dielectric. Considered good quality.
- polypropylene** A type of capacitor dielectric. Considered high quality.
- polystyrene** A type of capacitor dielectric. Considered high quality.
- pot** Colloquial abbreviation for potentiometer. See *potentiometer*.
- potentiometer** A three-terminal variable resistive device. Often used in power amplifier circuitry for precise adjustment of bias voltages and/or stage balance (the small type of potentiometers normally soldered into electronic circuits are called *trimpots*). Larger types of potentiometers are commonly used for operator controls (i.e., volume, tone, balance, etc.). By connecting the tap terminal and either end terminal, a potentiometer becomes a variable resistor, called a *rheostat*.
- power bridging** The act of connecting two or more power amplifiers together in bridge mode. See *bridge mode*.
- power density** The power output capability of an audio power amplifier expressed in terms of the physical size of the amplifier—for example, watts per cubic foot or watts per standard rack unit.
- power factor** A term describing AC mains power utilization. It is defined as the ratio of the actual consumed power to the apparent consumed power. The best theoretical power factor is 1, indicating that the load is entirely resistive. In reference to common types of audio amplifier power supplies, there is little the designer can do to improve the power factor, with typical values being from 0.5 to 0.7.
- predriver** In the context of audio power amplifiers, a term often applied to various transistors (or other active devices) used to drive the output devices. A rather ambiguous term since its usage has never actually been standardized.

- program** The original recorded or reproduced music and/or vocal signal. For example, a compact disc contains the program the user desires to listen to.
- program asymmetry** The phenomenon of complex AC signals (i.e., music) becoming asymmetrical in terms of their average sonic pressure (i.e., for short periods of time, complex musical programs can actually increase or decrease room pressure). When converted to electrical signals, program asymmetry results in DC shifts, both at the input and output of audio power amplifiers.
- pulse-width modulation** A technique wherein an audio signal is encoded into a corresponding square wave duty cycle. The fundamental frequency of the square wave is ultrasonic, and when applied to a speaker, the speaker coil will convert the duty cycle into a power wave. The power wave will be (it is hoped) a good reproduction of the original audio signal. Often, pulse-width modulated amplifiers are referred to as *digital amplifiers*. The advantage of pulse-width modulated amplifiers is extremely high efficiency. Pulse-width modulation is also a technique incorporated into many types of switching power supplies, as a method of regulation.
- push-pull** A condition in which output devices alternately control approximately one-half of the full output signal.
- quasi-complementary** An older method of output stage architecture, utilizing multiple transistors of the same *polarity* (i.e., all *npn*, for example) to simulate true complementary pairs. Of each quasi-complementary pair, one *npn* output transistor operates in a common-collector configuration, while the other *npn* transistor operates in a common-emitter fashion. While popular in the late 1960s and early 1970s, the advent of high-quality and relatively inexpensive true complementary BJT pairs replaced the need for quasi-complementary designs. A few manufacturers still use quasi-complementary architecture today, usually to reduce costs.
- quiescent** The steady-state condition of an electronic circuit without any signal applied.
- rectifier** Any device dedicated to the function of converting AC to DC. Can be in the form of solid-state devices (diodes) or vacuum tubes. The term is sometimes used in a general way to mean bridge rectifier. See *bridge rectifier*.

- regulated power supply** Any type of power supply with special circuitry added to maintain its output under a variety of loading conditions.
- regulation** The process of holding various quantities (e.g., voltage or current) constant in a system.
- regulator** A circuit or integrated circuit dedicated to maintaining regulation of an electrical variable. See *regulation*.
- reservoir** The adjective often applied to the large filter capacitors utilized in most raw DC power supplies. The connotation alludes to a storage area, or reservoir, of electrical energy.
- reservoir capacitors** Another name for *filter capacitors*. The large smoothing capacitors used to convert the pulsating DC output of power supply rectifiers to relatively constant DC.
- residue** In the context of electrical signals, a general term that applies to the unwanted content (i.e., distortion or noise) within a signal, or output, voltage. It is most often used in conjunction with audio distortion analyzers, in reference to the leftover residual signal.
- resolution** The ability to delineate, detail, or distinguish between nearly equal values of quantity. For example, a hypothetical control knob graduated into 100 equal increments has a minimum resolution of 1 increment. Resolution is often used to denote the smallest possible increment of any device or control.
- resonance** (1) The condition existing in a circuit when the inductive reactance equals the capacitive reactance. (2) In the context of audio amplifiers, the undesirable condition in which the inductive and capacitive elements of the amplifier circuit, in combination with the circuit gain, produce damped or sustained oscillation. (3) The natural frequency of mechanical vibration in a speaker system (or any other type of audio transducer).
- resonant power supply** A type of switching power supply incorporating a resonant tank circuit to reduce HF and RF emissions and improve efficiency. Resonant power supplies (or some variant of them) are used in some professional audio power amplifiers.
- RF filtering** Filters designed to remove any RF interference from audio circuitry (especially sensitive preamp and high-gain circuits). Special RF filter/shut-down circuits are sometimes incorporated into high-power audio amplifiers to automatically shut down the amplifier if RF oscillation is detected.

- RF oscillation** In the context of audio amplifiers, the sustained oscillations at radio frequency. This condition is very destructive to output stages and some speaker systems. It is notorious because it cannot be heard and is often difficult to easily detect.
- ringing** The condition of producing a damped oscillation.
- ripple** (1) The AC residual of a rectified and filtered DC power supply. (2) A general term for any repetitive and cyclic variation occurring in a processed waveform.
- ripple current** The cyclic AC current variations in power supply filter capacitors resulting from the pulsating DC output of the rectifier circuit.
- ripple voltage** The AC voltage component riding on the DC voltage of power supplies. The fundamental frequency is twice that of the mains supply (assuming a full-wave rectifier is incorporated in the power supply design). Ripple voltage is a primary cause of hum in audio power amplifiers.
- rolloff** In the context of audio power amplifiers, the frequency point at which the output voltage decreases to a specified amplitude (usually by -3 dB, denoting the half-power point). The frequency spectrum between the points of HF rolloff and LF rolloff determines the bandwidth. In general usage, *rolloff* is applied to any signal voltage that begins to decrease as frequency varies.
- safe operating area (SOA)** A BJT parameter curve illustrating all of the possible safe voltage or current zones where there is no danger that the BJT will go into secondary breakdown.
- saturation** (1) A condition in BJTs when they are driven beyond the fully on limits. When saturated, BJTs require longer turn-off time periods. (2) When the core material of an inductor reaches its limit of permeability. (3) In the context of acoustics, the point at which an increase in acoustic energy does not produce a proportional increase in loudness.
- schematic** A line drawing representation of an electric circuit.
- secondary breakdown** A destructive failure of a BJT, not resulting from exceeding any maximum voltage or current parameters but due to certain combinations of voltage and current interacting with the physics of BJT design.
- sensitivity** In the context of audio power amplifiers, the input signal level required to produce the maximum rated output power. Typically, this is about 1 volt RMS “line level.”

- separation** A figure of merit, describing the signal voltage isolation between two or more channels. The antonym of *crosstalk*. See *crosstalk*.
- servo** A type of negative feedback designed to autonull (i.e., cancel out) DC offsets at the output of audio power amplifiers. DC servosystems are designed to apply negative feedback to continuously correct for DC conditions only, with little or no feedback applied to the signal (i.e., little or no AC feedback).
- shield** The general term applied to the outside conductive layer of many types of cabling. The purpose of shielding is to isolate the internal conductors from the effects of RFI, EMI, and intra-cable signal leakage. Cable shielding is commonly implemented in the form of wire mesh or conductive foil.
- shoot through** See *cross-conduction*.
- shunt** Synonymous to *parallel*. Applied to circuit, component, feedback, and control schemes. Shunting is the act of connecting various components or circuits in parallel.
- siemens** Unit of conduction, synonymous to *mho* (an older term). The reciprocal of ohm.
- single ended** A general term, applied in contrast to *dual* or *dual ended*. Often applied to power supplies, output stages, or any type of circuit that is asymmetrical (i.e., nonbalanced, noncomplementary, nonbridged, etc.).
- single pole** (1) A single path or single contact pair of a switch or relay, respectively. (2) The basic rolloff response of a passive RL or RC network (that is, -6 dB per octave).
- skin effect** The tendency of high frequencies to flow through the outside surface, or skin, of a conductor.
- slew rate, or slew limit** The maximum rate of change of a signal or output voltage (typically measured in volts per microsecond). The term is usually applied to operational amplifiers and audio power amplifiers to define how rapidly the output will respond to instantaneous input changes. Although great confusion exists on this subject, there is little relationship between open-loop bandwidth and slew rate.
- sliding bias** The term used to describe the type of dynamic bias applied to the output stage of audio amplifiers designed to operate in class A during low-level operation and slide into class A-B operation during high-level operation.

- small signal** (1) A general term used to denote low-level output of an audio power amplifier. Typically, small signal is at or less than 20 percent of its rated power output. (2) The signal level within the preamp stages.
- snubbing capacitors** Capacitors placed across the diode bridge terminals in a power supply to reduce the RF noise emitted by the diode switching.
- soft start** A type of power supply (used in many high-power audio amplifiers) that will power up slowly as a means of eliminating AC power line surges.
- sones** A unit of loudness. A 1-kHz tone that is 40 dB above a listener's threshold of hearing produces a loudness of 1 sone.
- source follower** An FET equivalent of a BJT emitter follower.
- speaker level** Signal voltages at the correct level to drive speaker systems (can range anywhere from 2 volts to over 200 volts RMS).
- star ground** A nodal point for two or more ground connections. So named due to the star lockwasher often used to assure good conductivity and mechanical reliance.
- steady state** (1) Synonymous with *quiescent*. See *quiescent*. (2) A steady signal level or a continuous periodic waveform.
- stereo** Audio signals in the form of two simultaneous channels, representing left and right listening perspectives.
- stiff** (1) In the context of audio power amplifiers, any amplifier with a high damping factor specification (i.e., very low output impedance). (2) A power supply with very low output impedance. (3) A low-compliance speaker.
- stray capacitance** Incalculable circuit or system capacitance resulting from component spacing, PC board track proximity, and wiring paths. Synonymous with *parasitic capacitance*. See *parasitics*.
- stray field** Usually applies to an undesired EMI field but is sometimes used to denote ESD or RFI fields.
- subharmonic** A frequency that is an integer fraction of a fundamental frequency.
- subjectivism** The antithesis of rational and scientific evaluation. Human perception without qualification.
- subsonic** A synonym for *infrasonic*. See *infrasonic*.
- substrate** The base, or foundational, material on which solid-state devices are constructed.

- supply rails (or DC supply rails)** The DC power supply busses internally located within audio power amplifiers.
- surge** A temporary swelling (increase) in either voltage or current.
- swamp** (1) A slang term meaning to cover up one signal with another signal of higher amplitude. (2) A type of class D amplifier developed by Infinity Systems. SWAMP was an acronym for “SW-itch AMP-lifier.”
- sweep** To span a variable range. Usually applied to frequency, denoting the variance of a frequency between two specified points.
- swing** The maximum output excursion (almost always in terms of voltage) of a circuit, amplifier, or operational amplifier.
- Sziklai** A complementary audio amplifier output configuration, synonymous to the *complementary feedback pair*. See *complementary feedback pair*.
- tandem mode** (1) Synonymous to *parallel mode*. See *parallel mode*. (2) When two or more power amplifiers are equally driven by a single source.
- thermally out** A slang expression to describe an audio power amplifier that has automatically shut itself off due to excessive heating.
- thermal noise** Electrical noise produced by the random motion of free electrons in conductors and semiconductors. The effect increases with temperature. Also known as *Johnson noise*.
- thermal runaway** A self-perpetuating thermal degeneration condition characteristic to BJT devices. It occurs when a quiescent bias enables a collector current to flow that is large enough to cause heat buildup in the BJT collector junction. Due to the positive temperature coefficient of BJTs (i.e., relative to current flow), the heat buildup instigates an increase in collector current, creating more heat, causing more current to flow, etc. If the BJT quiescent bias is not reduced to compensate for this runaway condition, the BJT will destroy itself. Some types of MOSFETs are susceptible to this condition also.
- thermistor** A type of semiconductor resistor, designed to change resistance value in accordance with temperature changes. Thermistors are available with either positive or negative temperature coefficients.
- timbre** The signature of a musical instrument. The unique blend and phasings of harmonics that create a unique sound peculiar to a specific instrument.

- tolerance** The maximum allowable deviation from published specification. The term is usually applied to acceptable variances of discrete components.
- tone burst** A type of test pattern (i.e., a specific number of cycles within a square wave envelope) used to test transient response in audio equipment.
- tone generator** A synonym for *audio signal generator*. See *audio signal generator*.
- topology** The “architecture” (i.e., the physical structure, or layout) of a populated printed circuit board.
- toroidal** A type of inductor or transformer constructed on a round, doughnut-shaped core. Although more expensive, toroidal transformers are more efficient, weigh less, and produce less EMI than standard E+I transformers.
- total harmonic distortion (THD)** Harmonic distortion is distortion in which undesired harmonics are generated due to circuit nonlinearity. Since the primary method of THD extraction will include whatever noise characteristics are inherent to the amplifier under test, the technically accurate way of expressing THD measurements is “percent THD+N” (the N stands for noise).
- trace** (1) A “line” of copper track on a PC board. (2) The luminous line on an oscilloscope.
- transconductance** The phenomenon of controlling a current with a voltage. Transconductance amplifiers convert a signal voltage to a corresponding (or proportional) current signal. Traditionally, transconductance has been thought of as the amplification factor of vacuum tubes and FETs; however, the term is also appropriate for BJTs.
- transducer** Any device capable of converting one form of energy to another. In the context of audio systems, the most notable transducers are speakers (i.e., they convert electrical energy to sonic energy).
- transfer function** The mathematical relationship between the output and the input of an electrical circuit or signal path.
- transformerless** A direct-coupled audio power amplifier (i.e., devoid of any type of output transformer, hence *transformerless*).
- transient** Any brief and abrupt change in signal properties or circuit operation. *Spikes* or *glitches* are slang synonyms.

- transimpedance** The process of converting a current to a proportional voltage. Analogous to *transresistance*, but used in the context of AC voltages and currents.
- transistor** The common name for *bipolar junction transistor*, or BJT. A three-layer, three-lead, two-junction active solid-state device. The most common active building block of solid-state circuitry.
- transition frequency** The high-frequency parameter of a BJT. Essentially, it is the high-frequency point at which the transistor's gain qualities drop to -3 dB.
- transresistance** The process of converting a current to a proportional voltage. Analogous to *transimpedance*, but used in the context of DC voltages and currents.
- triamp** Colloquial name for any audio system using active crossovers to divide the audio signal into three frequency groupings (i.e., treble, midrange, bass). The three audio channels are then amplified by three dedicated audio power amplifiers and applied to a speaker system without any internal crossover network (the crossover was accomplished prior to the amplification stage).
- trimcap** A small, PC board size adjustable capacitor.
- turn-on delay circuit** See *muting*.
- twisted pair** A type of audio cable. As the name suggests, the conductors are twisted around themselves, providing improved immunity to RF and other transmitted interferences (both transmitted and received). Commonly used in conjunction with balanced sources and destinations.
- ultrasonic** Frequencies above the human hearing range.
- unbalanced** In the context of audio systems, any signal without a complementary counterpart (i.e., a single-ended signal).
- unstabilized (unstabilised)** A British term meaning “nonregulated.” The term is typically applied to raw (nonregulated) power supplies.
- variac** An adjustable autotransformer, normally used for testing purposes. The turns ratio is established to provide a range of zero to about 110 percent of the AC mains voltage. Variacs *do not* provide isolation, so appropriate caution should be exercised when using.
- volt** The basic unit of electromotive force (EMF). The force of 1 volt is required to move 1 ampere of current through 1 ohm of resistance.
- watt** The basic unit of power (energy transfer). One joule per second is equal to 1 watt.

winding resistance The DC resistance of the wire in an inductor or transformer coil.

Zobel network The RC circuit placed across the output of almost all audio power amplifiers. Its function is to help stabilize the power amplifier under a variety of load situations.

Electronic Units and Abbreviations

This listing is not intended to be general to the electronics industry. Rather, it is a quick reference within the context of audio amplifier construction and related audio subjects. I have tried to illustrate these abbreviations and acronyms in the most commonly used formats (i.e., font, case, and style). However, abbreviation formats will vary widely from one publication to another. Abbreviations with multiple definitions must be defined based on the context used in accordance with the abbreviation.

A, a	(1) Ampere, basic unit of electrical current. (2) Signal gain or loss, in decibels.
AC	Alternating current (also used to designate “periodic” voltage)
A_e, A_v	Voltage gain
A_{eol}, A_{vol}	Open-loop voltage gain
Ah	Ampere hour
AM	Amplitude modulation
amp	(1) Amplifier. (2) Occasionally, an abbreviation for ampere.

ant	Antenna
assy	Assembly
aud	Audio
AUT	Amplifier under test
aux	Auxiliary
AWG	American wire gauge
B, b	(1) Magnetic flux density in gauss or tesla. (2) The base terminal of a BJT. (3) Current gain factor of a BJT (beta or h_{FE}). (4) Feedback factor.
BJT	Bipolar junction transistor; the most common type of three-layer transistor
BW, Bw	Bandwidth
C, c	(1) Schematic symbol for a capacitor. (2) Collector terminal of a BJT. (3) Capacitance. (4) Coulomb.
CB	Common base
C_{dg}	Drain-to-gate capacitance
C_{ds}	Drain-to-source capacitance
CE	Common emitter
CFP	Complementary feedback pair
C_{gs}	Gate-to-source capacitance
C_{iss}	Gate-to-source capacitance; input short-circuited, common source configuration
C/L	Closed loop
CM	Common mode
C_{ob}	Output capacitance
C_{obo}	Open circuit output capacitance; common base configuration
C_{obs}	Short-circuit output capacitance; common base configuration
C_{oss}	Short-circuit output drain-to-source capacitance; common source configuration
C_{rss}	Short-circuit reverse transfer capacitance; input to output; source short-circuited to gate; common source configuration
D, d	(1) Drain lead of an FET. (2) Dissipation factor; reciprocal of storage factor Q. (3) Thickness of the dielectric material in a capacitor (measured in centimeters).

dB	Decibel (one-tenth of a bel); the logarithmic ratio between two levels of power
DC, dc	Direct current
DPDT	Double-pole, double-throw (i.e., relative to switches and relays)
DPST	Double-pole, single-throw (i.e., relative to switches and relays)
DVM	Digital voltmeter
E, e, emf	(1) Electromotive force, measured in volts. (2) Emitter lead of a BJT.
EF	Emitter-follower
ERP	Effective radiated power
eV	Electron volt
F, f	(1) Frequency, in hertz. (2) Farad, basic unit of capacitance. (3) Temperature, measured in degrees Fahrenheit.
FET	Field-effect transistor
FM	Frequency modulated
f_T	Transition frequency of a BJT
G, g	(1) Giga, prefix for 1,000,000,000. (2) Gate lead of an FET. (3) Conductance, measured in seimens or mhos.
g_{fs}	Forward transfer admittance
GHz	Gigahertz (1,000,000,000 Hz)
g_m	Mutual conductance
H	(1) Magnetic field strength (amperes per meter). (2) Henry, basic unit of inductance.
HF	(1) High frequency. (2) In the context of audio power amplifiers, often refers to frequencies above the dominant-pole frequency.
H_{FE} , h_{FE}	Beta, current gain parameter of a BJT (<i>Note:</i> Uppercase letters denote DC gain parameters, while lowercase denotes small-signal AC gain figures.)
HT	High tension (high voltage and current)
HV	High voltage
Hz	Hertz
I	Electrical current, measured in amperes

I_B	BJT base current
IC	Integrated circuit
I_C	BJT collector current
I_{cbo}	BJT base leakage current; measured with the emitter open
I_{ceo}	BJT emitter-to-collector leakage current with the base open
I_D	FET drain current
$I_{D(ON)}$	On-state drain current
I_{DSS}	FET leakage from drain to source with the gate open
IF	Intermediate frequency
I_{GSS}	Gate current with the drain to source short-circuited
IN, in	Input
I/O	Input-output
I/P	Input
J	Joule; basic unit of energy
JFET	Junction field-effect transistor
K	(1) Cathode. (2) Kelvin; basic unit of temperature on the Kelvin scale. (3) Coupling coefficient.
k	(1) Kilo; prefix for 1000. (2) Dielectric constant.
kHz	Kilohertz
kV	Kilovolt
kW	Kilowatt
kWh	Kilowatthour
L	Inductance; measured in henries
LF	(1) Low frequency. (2) In the context of audio power amplifiers, often refers to frequencies below the dominant-pole frequency.
LP	Low pass
LSI	Large-scale integration
m	(1) Milli; prefix for a thousandth (1/1,000). (2) Meter; basic unit of length.
M, meg	(1) Mega; prefix for a million. (2) Mutual inductance.
mic	Microphone

mom	Momentary
MOSFET	Metal-oxide semiconductor field-effect transistor
mv	Millivolt
n	(1) Nano; prefix for 1/1,000,000,000 (that is, 1×10^{-9}). (2) Turns ratio.
NC	(1) Normally closed. (2) No connection.
neg	Negative
neut	Neutral
NF	Noise figure
NFB	Negative feedback
NO	Normally open
nom	Nominal
O/L	Open loop
osc	Oscillator
out	Output
p	Pico; prefix for a trillionth (that is, 1×10^{-12})
P	Power, measured in watts
P1	The low-frequency open-loop response pole
P2	The high-frequency open-loop response pole
P, Pri	Primary of a transformer
PC	(1) Personal computer. (2) Printed circuit.
PCB	Printed circuit board
P_D	Maximum or total power dissipation (sometimes denoted “ P_T ”)
pF	Picofarad
pf	Power factor
PK, pk	Peak
pos	Positive
pot	Potentiometer
pri	Primary
PSRR	Power supply rejection ratio
PSU, PS	Power supply unit
PWM	Pulse width modulated

Q	(1) A figure of merit for an energy-storing device, tuned circuit, or resonant system; equal to the reactance divided by the resistance. (2) When specifying inductor quality, the ratio between the inductance and coil resistance. (3) Quantity.
R	Resistance, in ohms
R _b , r _b	Base resistance of a BJT
R _c , r _c	Collector resistance of a BJT
rcvr	Receiver
r _{ds(on)}	Small signal; drain to source on-state resistance
r _{DS(ON)}	DC drain-to-source on-state resistance
R _e , r _e	Emitter resistance of a BJT
rect	Rectifier
ref	Reference
RF	Radio frequency
RFI	Radio frequency interference
R _{j-a}	Thermal resistance of a semiconductor; core to ambient
R _{j-mb}	Thermal resistance of a semiconductor; core to mounting base
R _L	General abbreviation for a load (may be resistive or reactive)
RLY	Relay
R _{mb-sink}	Thermal resistance of a semiconductor; mounting base to heatsink
RMS, rms	Root mean square
rmt	Remote
R _{ON}	On resistance of a MOSFET
R _s , r _s	Source impedance
R _{TH}	Thermal resistance
R _{THCS}	Thermal resistance from a semiconductor case to heatsink
R _{THINS}	Thermal resistance of a semiconductor insulator
R _{THJC}	Thermal resistance of an internal semiconductor junction to its outside case
R _{THJA}	Thermal resistance of a semiconductor junction to the ambient air
R _{THSA}	Thermal resistance of a heatsink to the ambient air

S, s	(1) Siemens; basic unit of conduction (replaced the older term “mho”). (2) Source lead of an FET. (3) Seconds (time or arc). (4) Area of one plate of a capacitor (measured in square centimeters).
SB	Sideband
sec	Secondary
sig	Signal
SNR	Signal-to-noise ratio
SPDT	Single-pole, double-throw (i.e., relative to switches and relays)
spk, spkr	Speaker
SPST	Single-pole, single-throw (i.e., relative to switches and relays)
sq	Square
sw	Switch
T, t	(1) Tesla, basic unit of magnetic field strength. (2) Time, usually in seconds. (3) Temperature, usually in °C unless otherwise specified. (4) Transformer.
T_A, T_{amb}	Ambient temperature
THD	Total harmonic distortion
T_J	Junction temperature of a semiconductor device
t_{off}	Turn-off time
t_{on}	Turn-on time
t_{stg}	Storage temperature
t_r	Rise time
t_{rr}	Reverse recovery time
V, v	Voltage; electromotive force
VA	Voltampere
VAS	Voltage amplifier stage
V_{be}	Base-to-emitter voltage of a BJT
V_{EBO}	Emitter-to-base voltage of a BJT with the collector open (sometimes denoted “ BV_{EBO} ”)
$V_{BE(SAT)}$	Base-to-emitter saturation voltage of a BJT
V_{CBO}	Collector-to-base voltage of a BJT with the emitter open (sometimes denoted “ BV_{CBO} ”)

V_{ce}	Collector-to-emitter voltage of a BJT
V_{CEO}	Collector-to-emitter voltage of a BJT with the base open (sometimes denoted “ BV_{CEO} ”)
$V_{CEO(SUS)}$	Maximum collector-to-emitter voltage with the base open
V_{DS}	Drain-to-source voltage of an FET
V_{GS}	Gate-to-source voltage of an FET
$V_{GS(th)}$	Gate-to-source threshold voltage
V_{in}	Input voltage
VOM	Voltohmmeter
V_{out} , V_o	Output voltage
VTVM	Vacuum tube voltmeter
$V/\mu s$	Volts per microsecond
W	Watt; basic unit of power
WVDC	Working volts DC
X	Reactance (measured in ohms); the opposition to alternating current exhibited by reactive components
Y	Admittance (measured in seimens or mhos); the reciprocal of impedance
Y_{fs}	Forward transadmittance of an FET
Z	Impedance (measured in ohms); the reactive and resistive opposition to the flow of alternating current
Z_{IN}	Input impedance
Z_{OUT}	Output impedance
Π , π	Pi. Equal to 3.1416...
Ω	Ohm
μ	Micro (1×10^{-6})

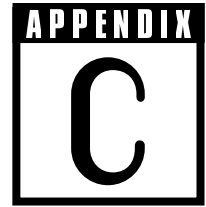

PC BOARD ARTWORK

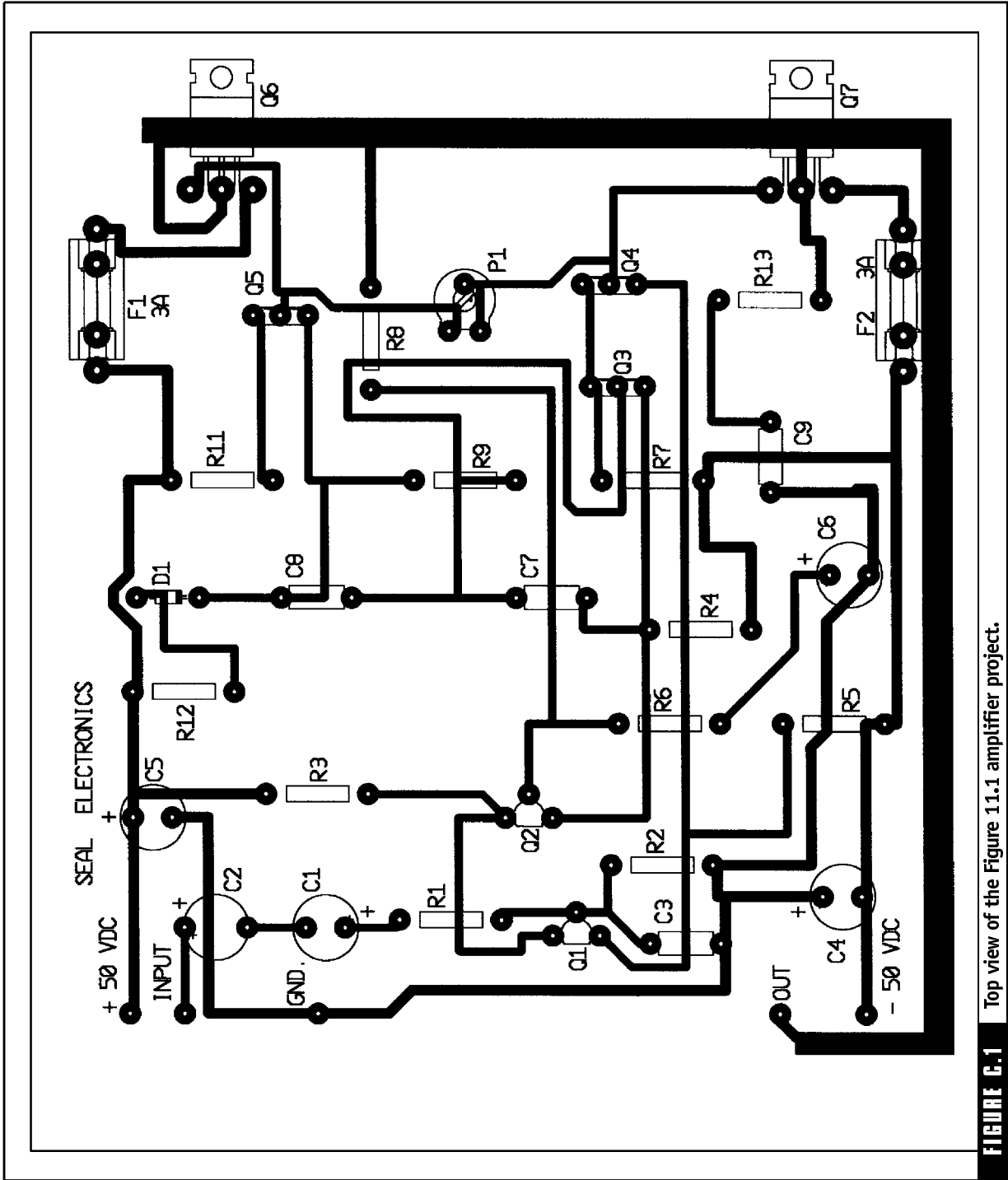

FIGURE G.1 Top view of the Figure 1.1.1 amplifier project.

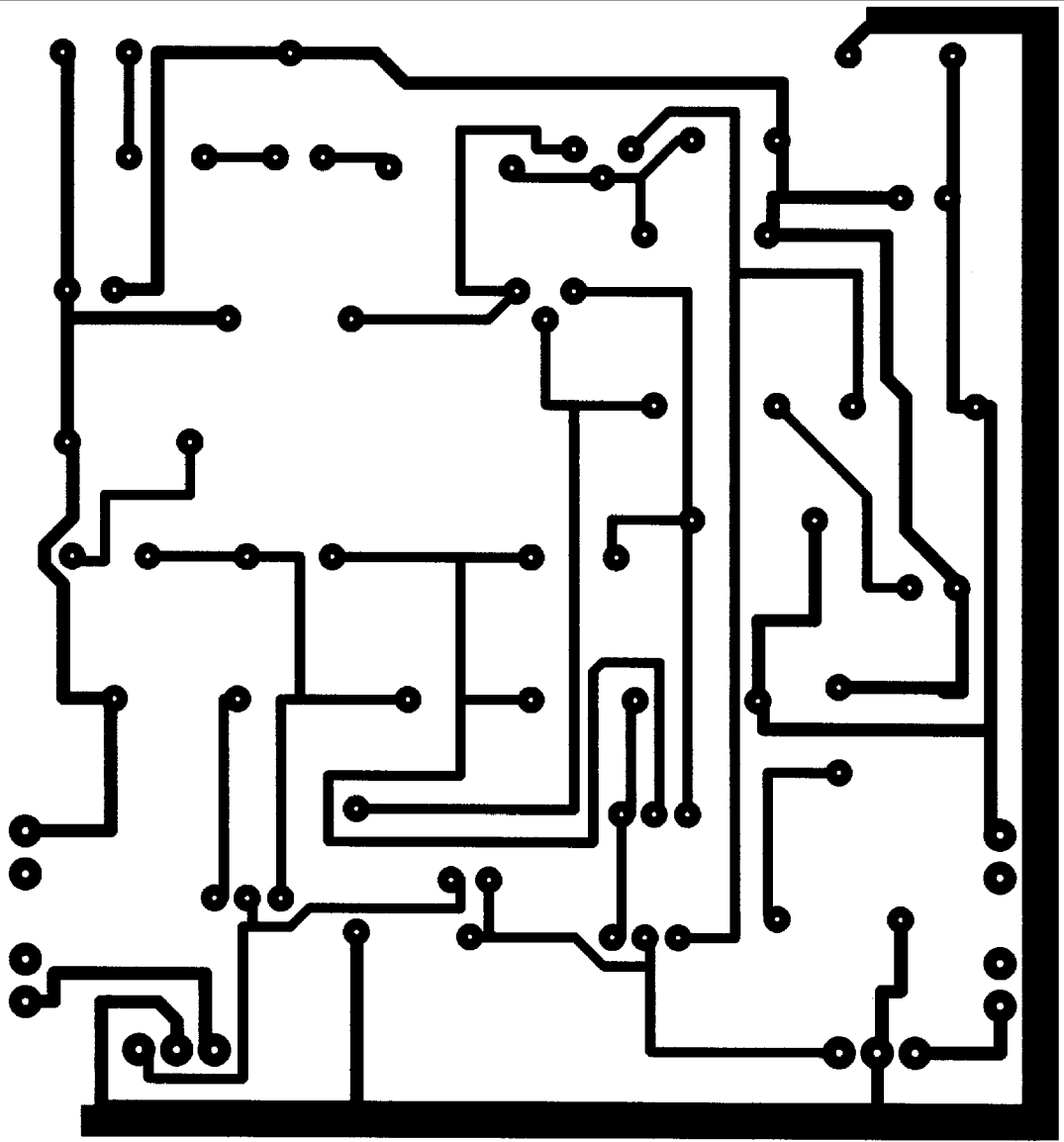

FIGURE C.2 Bottom PC board artwork for the Figure 11.1 amplifier project.

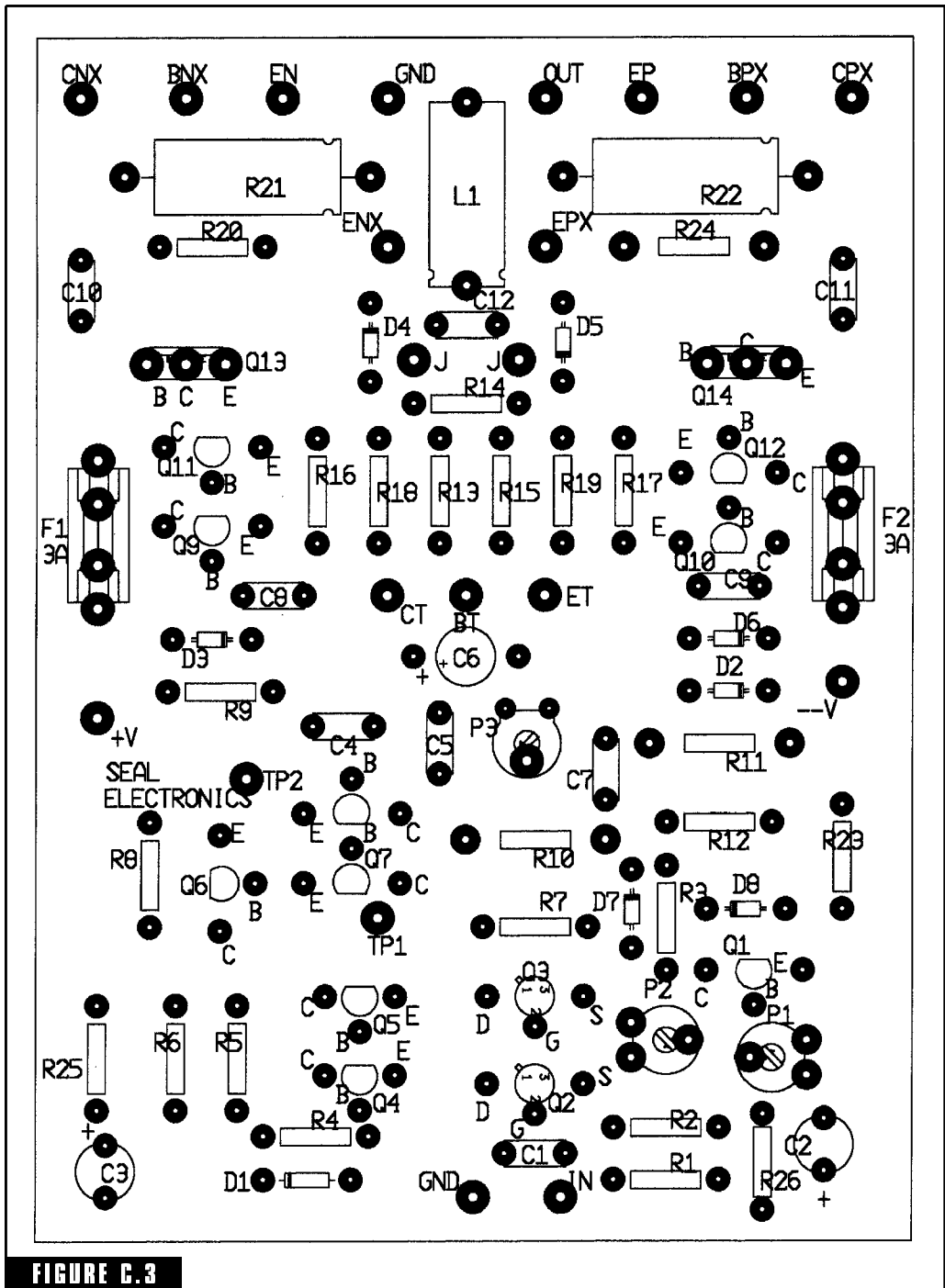

FIGURE C.3

Top view of the Figure 11.2 amplifier project.

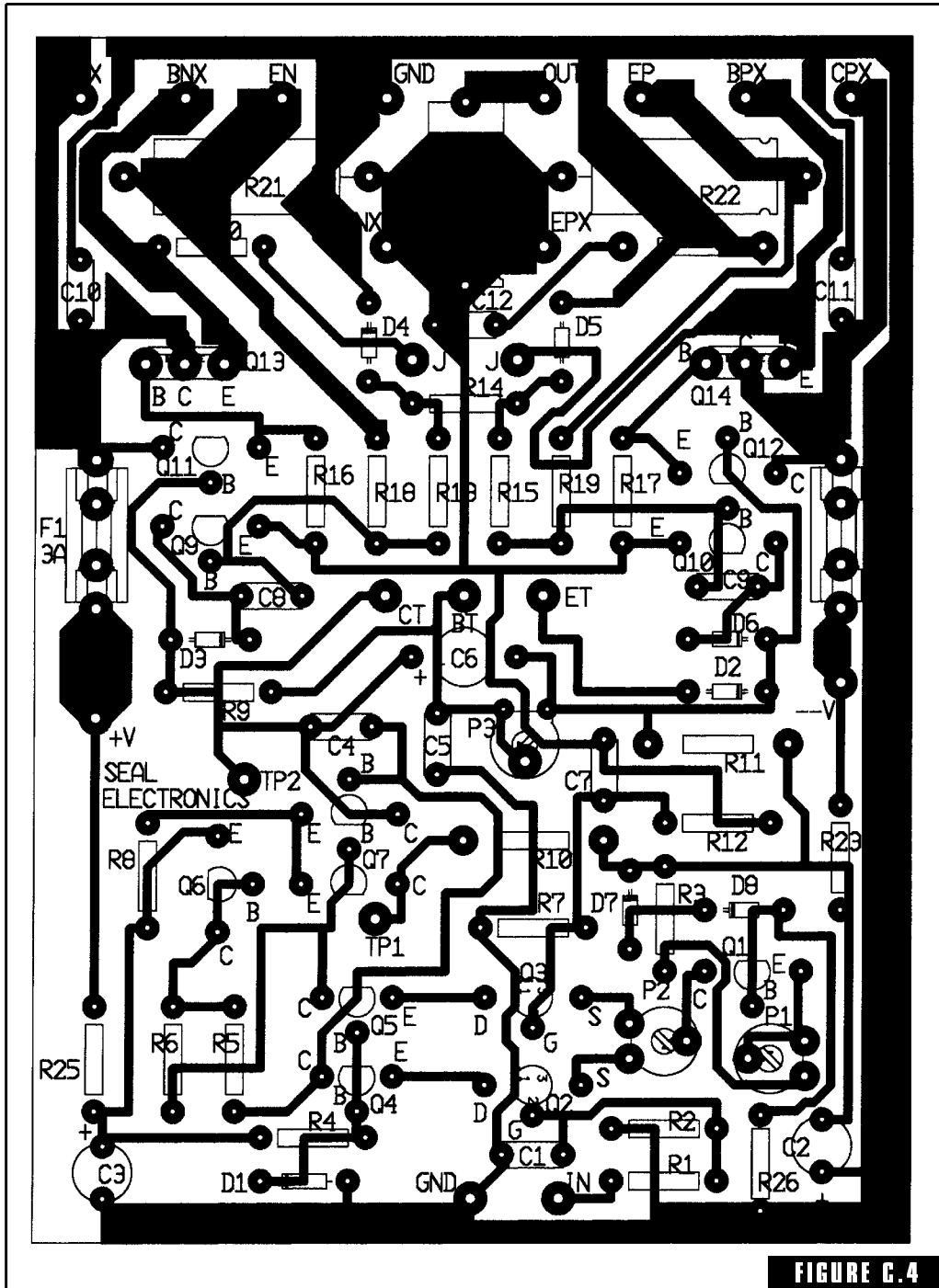
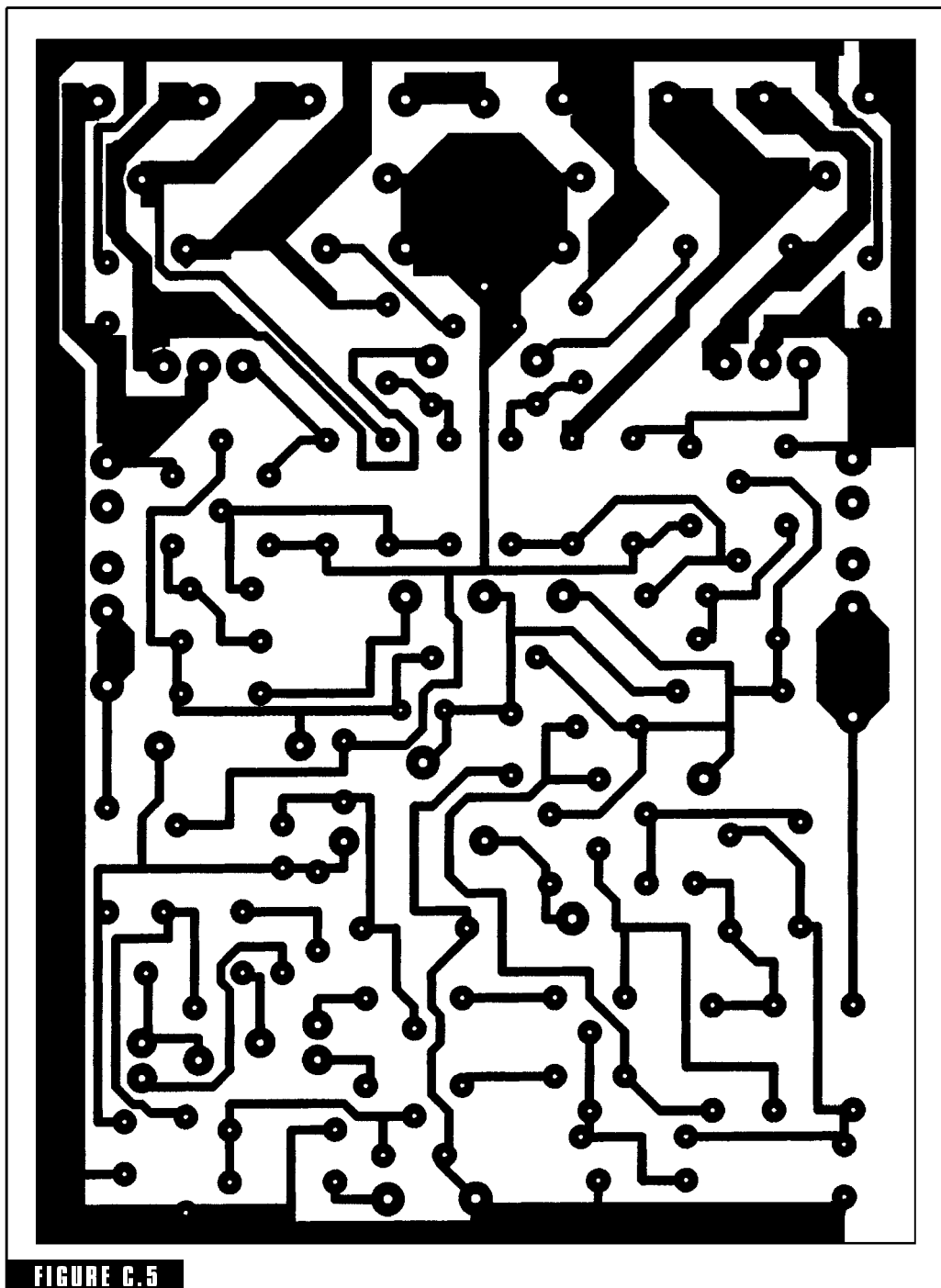

FIGURE C.4

Top view of the Figure 11.2 amplifier, illustrating top view of PC artwork.



Bottom view of PC board artwork for the Figure 11.2 amplifier project.

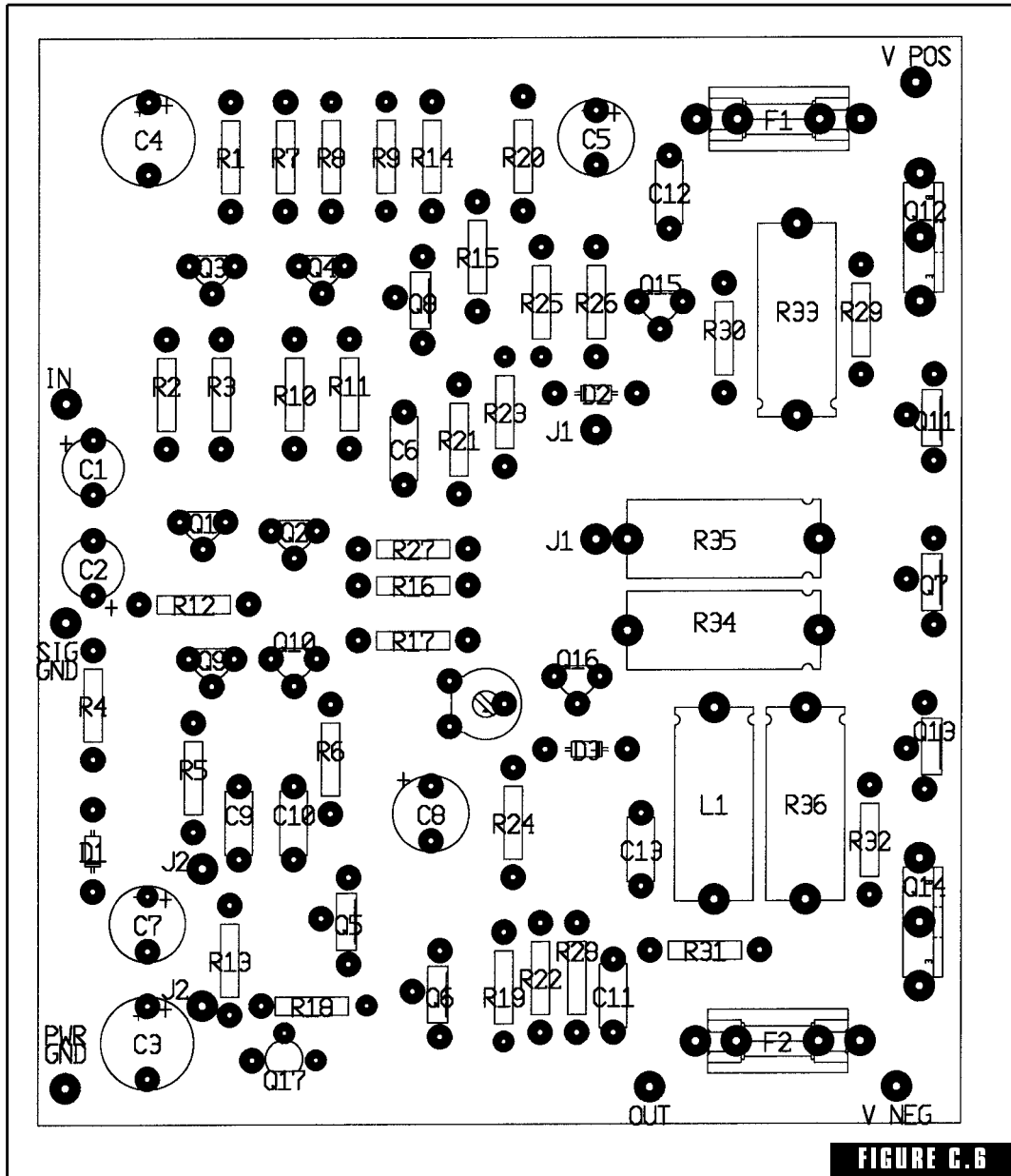

FIGURE C.6

Top view of the Figure 11.4 amplifier project.

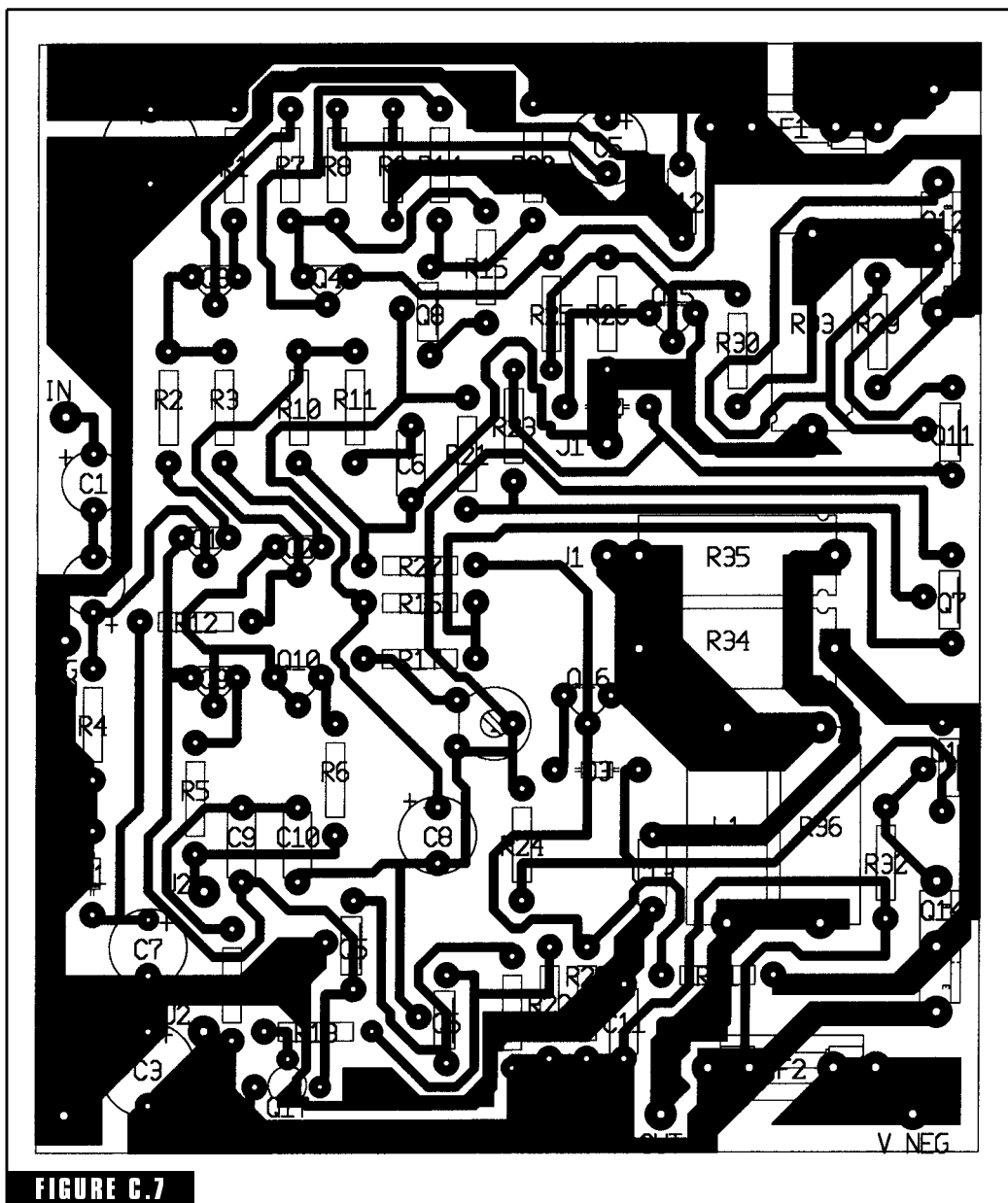
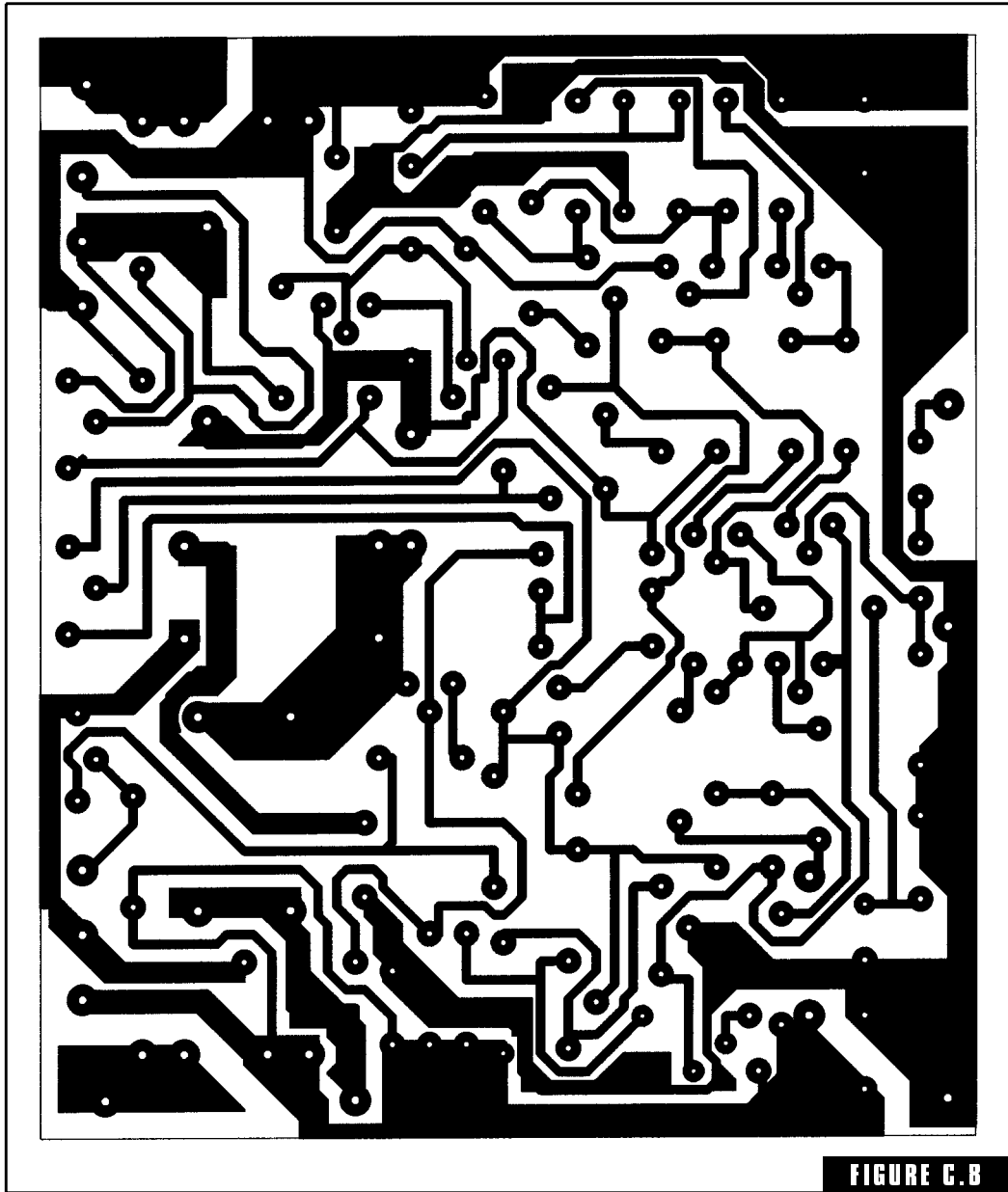

FIGURE C.7

Top view of the Figure 11.4 amplifier project, illustrating top view of PC artwork.



Bottom view of PC board artwork for the Figure 11.4 amplifier project.

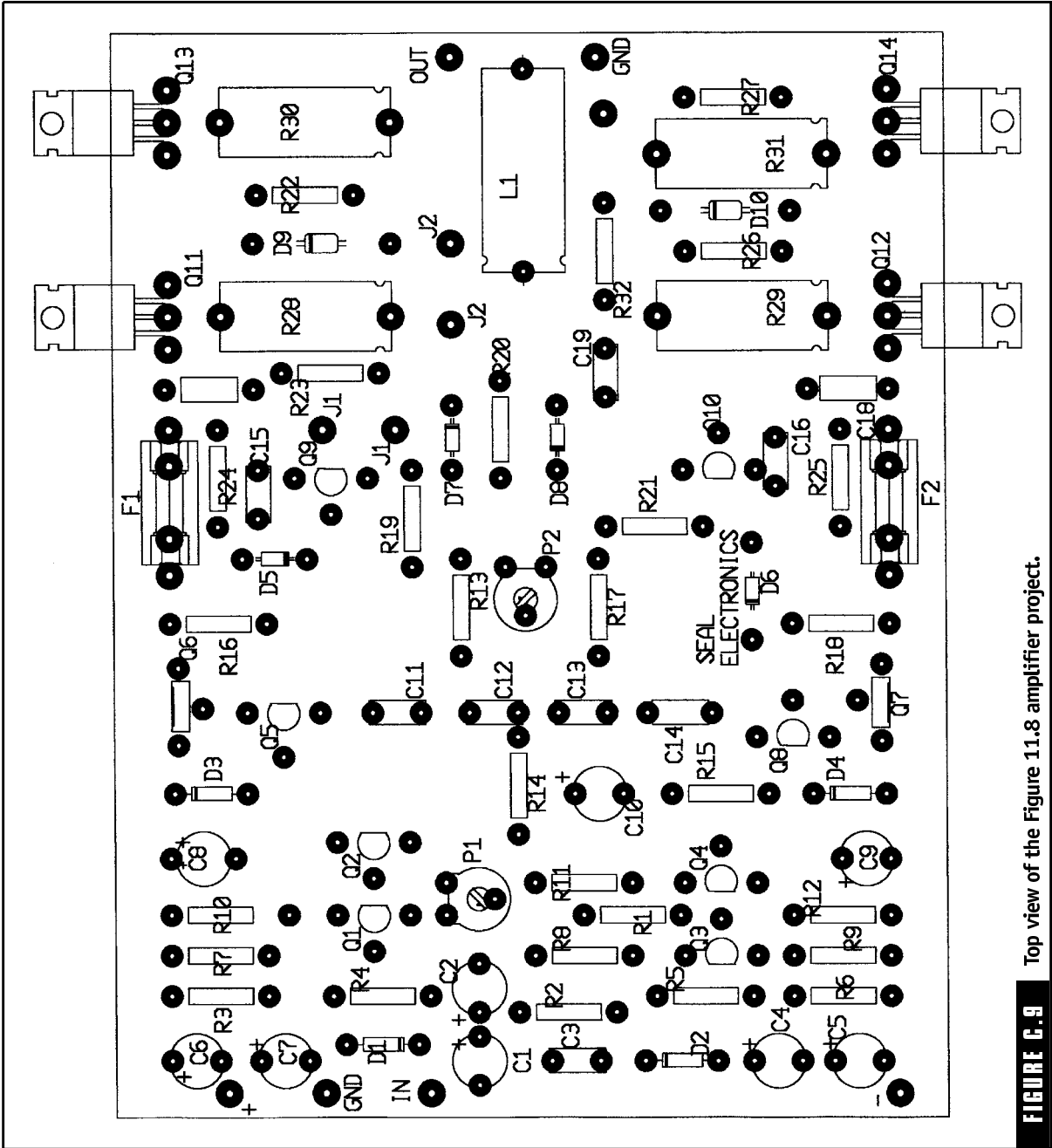

FIGURE C.9 Top view of the Figure 11.8 amplifier project.

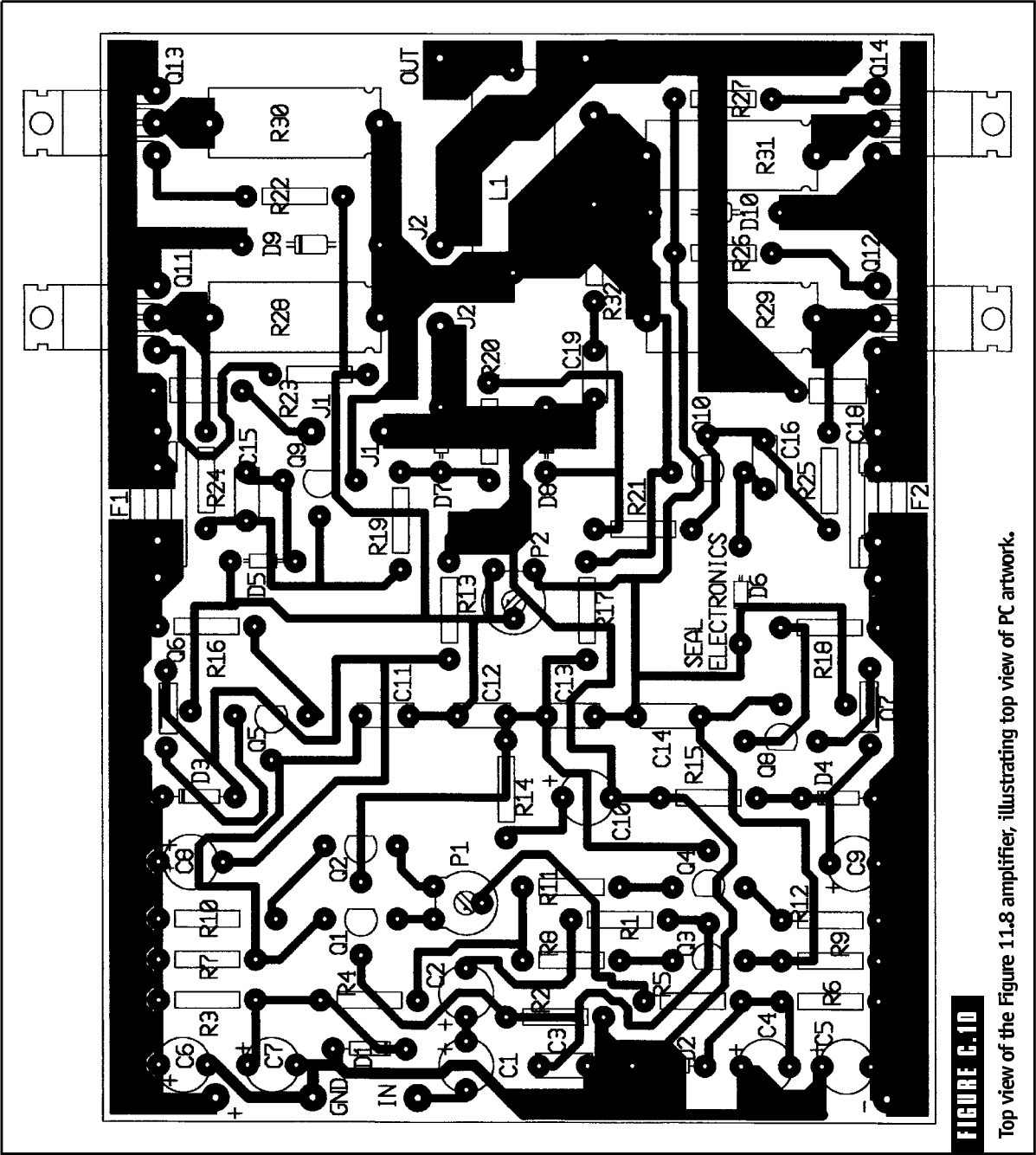

FIGURE 6.10

Top view of the Figure 11.8 amplifier, illustrating top view of PC artwork.

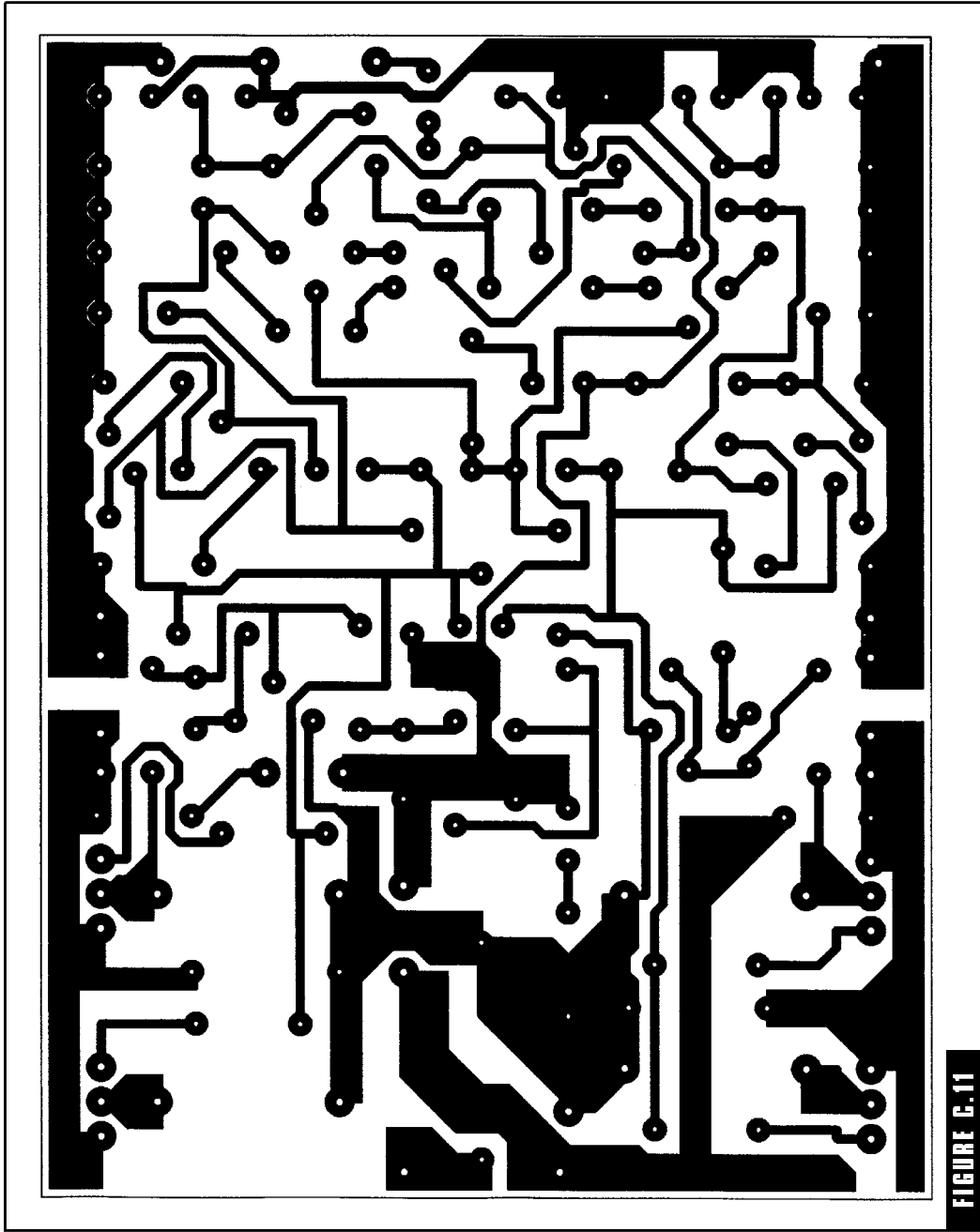

FIGURE C.11

Bottom view of PC board artwork for the Figure 11.8 amplifier project.

SEAL ELECTRONICS

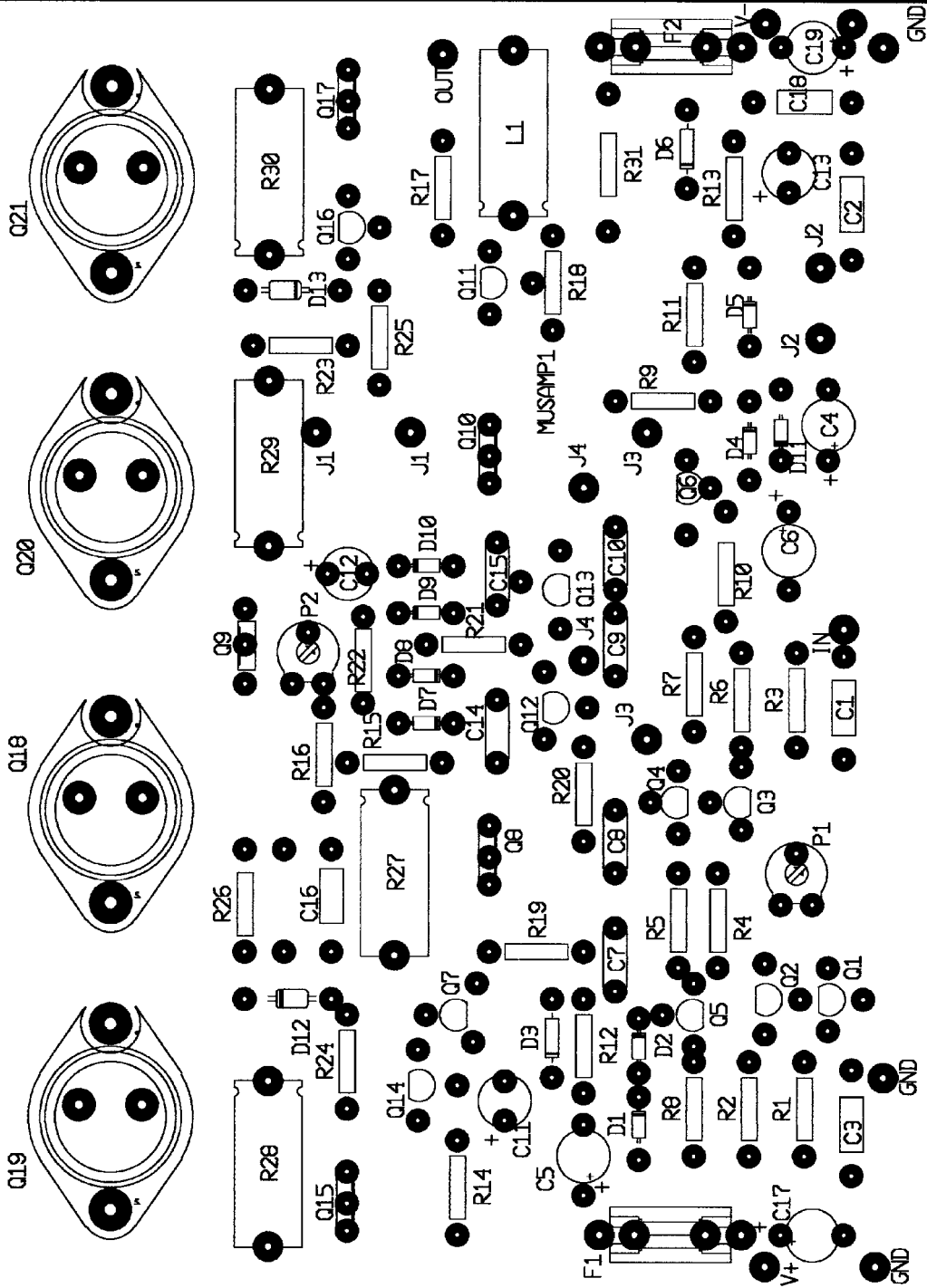

FIGURE G.12 Top view of the Figure 11.11 amplifier project. (Note: This view is 92 percent of full size.)

SEAL ELECTRONICS

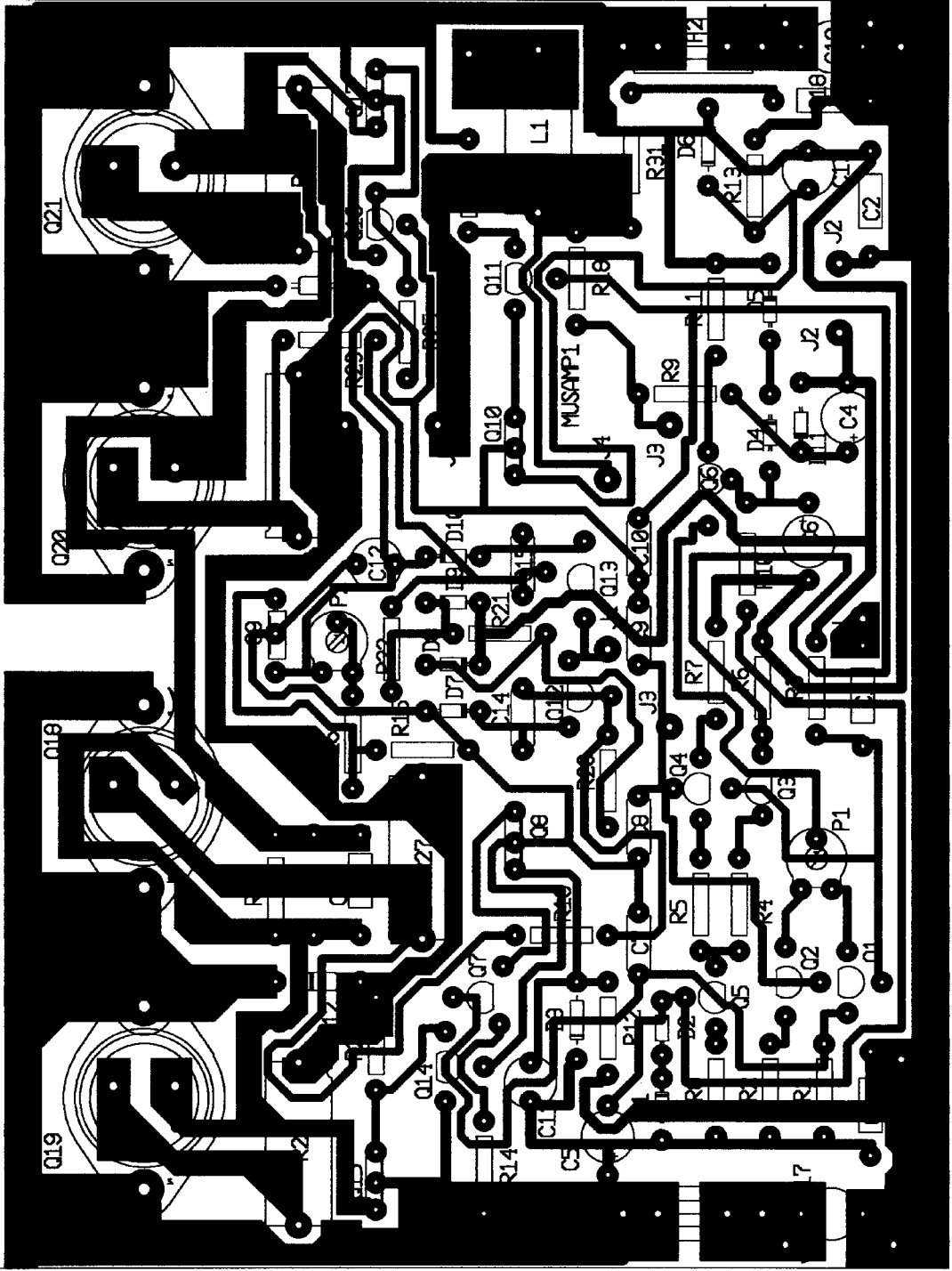
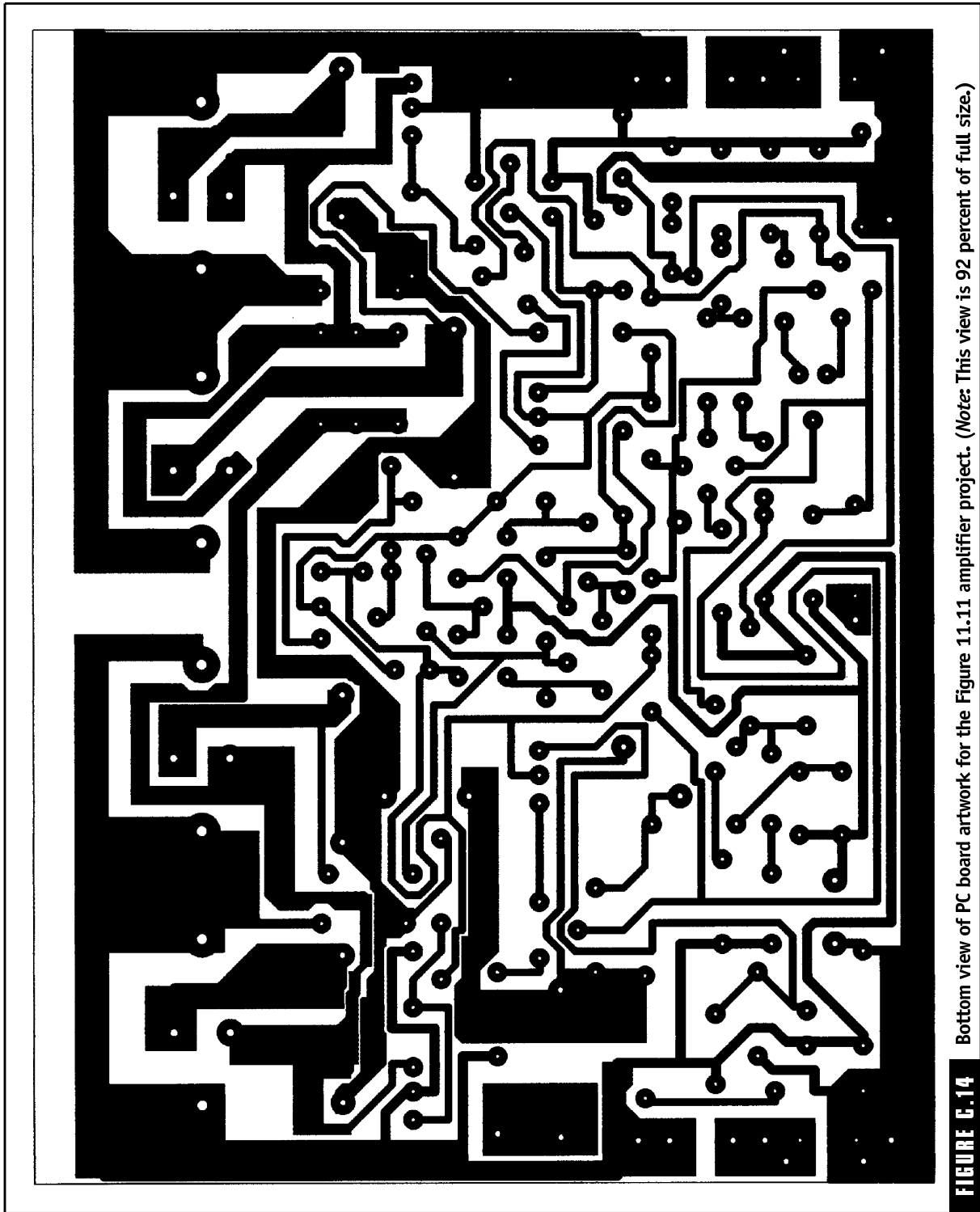

FIGURE C.13 Top view of the Figure 11.11 amplifier, illustrating top view of PC artwork. (Note: This view is 92 percent of full size.)



Bottom view of PC board artwork for the Figure 11.11 amplifier project. (Note: This view is 92 percent of full size.)

FIGURE G.14

This page intentionally left blank.

Sources of Information and Materials

Parts and Materials Suppliers

Seal Electronics provides preetched and drilled PC boards for all of the projects in this book. In addition, Seal Electronics carries a complete line of power supply components, output devices (including L-MOSFETs), and other audio amplifier construction supplies.

Seal Electronics
Post Office Box 268
Weeksbury, KY 41667
(606) 452-4135
sealelec@eastky.net

Parts Express and MCM Electronics carry a complete line of passive and semiconductor components for audio power amplifiers, together with an excellent selection of other audio equipment, including speaker systems (and individual drivers), cabinets, enclosures, soldering supplies, hardware, test equipment, and miscellaneous supplies.

Parts Express
725 Pleasant Valley Drive
Springboro, OH 45066-1158
1-800-338-0531

MCM Electronics
650 Congress Park Drive
Centerville, OH 45459-4072
1-800-543-4330

Three of my favorite electronic surplus suppliers are as follows:

B.G. Micro
Post Office Box 280298
Dallas, TX 75228
1-800-276-2206

All Electronics Corp.
Post Office Box 567
Van Nuys, CA 91408-0567
1-800-826-5432

Fair Radio Sales Co.
Post Office Box 1105
Lima, OH 45802
(419) 223-2196
(419) 227-6573

For a complete line of PC board fabrication equipment, tools, supplies, and chemicals, write to or call the following company:

Circuit Specialists, Inc.
220 South Country Club Drive, No. 2
Mesa, AZ 85210-1248
1-800-811-5203 or (602) 464-2485

Recommended for Further Reading

Ben Duncan, *High Performance Audio Power Amplifiers*, Newnes Publications (an imprint of Butterworth-Heinemann, Ltd.). Copyright 1996, ISBN: 0-7506-2629-1.

Douglas Self, *Audio Power Amplifier Design Handbook*, Newnes Publications (an imprint of Butterworth-Heinemann, Ltd.). Copyright 1996, ISBN: 0-7506-2788-3.

Editors of *Audio Amateur Magazine*, *Audio Amateur Power Amp Projects*, Audio Amateur Publications, Inc., Copyright 1996, ISBN: 1-882580-08-7.

Note: All of the previously listed titles can be purchased from the Old Colony Sound lab, Post Office Box 876, Peterborough, NH 03458-0876. Telephone (603) 924-7292.

Software Construction and Evaluation Tools

Interactive Image Technologies, Ltd.
(Distributors of the *Electronics Workbench* programs)
111 Peter Street, No. 801
Toronto, Canada
M5V 2H1
(416) 977-5550

Pioneer Hill Software
(Distributors of the *Spectra Plus* analysis systems)
24460 Mason Road
Poulsbo, WA 98370
(360) 697-3472

Recommended Periodicals

Audio Electronics Magazine
For subscription contact: Circulation Department
Post Office Box 876
Peterborough, NH 03458
(603) 924-9464

This page intentionally left blank.

INDEX

- A weighting, 49
- Absolute maximum ratings, 247
- Absolute phase, 54–55
- Acoustic therapy, 34–35
- Activation temperature, 370
- Adaptive class G, 150
- Amplifier under test (AUT), 18
- Analysis equipment, computerized, 391–392
- Applications of audio power amplifiers, 6–7
- Architectures, audio power amplifier, 58–60
- Audio amplification:
 - definition of, 1–2
 - social and economic importance of, 3
- Audio Precision System One, 392
- AUT (amplifier under test), 18

- Ballasting, 177
- Bandwidth, 5
- Base-to-collector capacitance, 205
- Base-to-emitter capacitance, 205
- Baxandall, Peter, 17
- Belly-band, 301
- Beta-droop distortion, 24, 228–231
- Bias, 143
- Bias generator stability, 196–201, 223
- Bipolar junction transistors (BJTs), 41,
 - 66, 68, 90, 113, 114
 - output stage, 162–182
 - complementary-feedback design, 169–172
 - emitter-follower design, 163–168
 - MOSFET output vs., 183–187
 - paralleled output stages, 177–180
 - quasi-complementary design, 172–173
- Bipolar junction transistors,
 - output stage, (*Cont.*):
 - triples, output, 174–177
 - protecting, 247–252, 267–270
- Bleeder resistors, 306
- Bootstrapped VA stage, 114
- Boucherot cell, 209
- Break points, cost, 52
- Bridge rectifier, 291
- Buffered VA stage, 114–115

- Cables, speaker, 33
- Capacitor distortion, 233–234
- Capacitor-inductor analyzer, 388
- Capacitors, 31
 - reservoir, 289, 305–306
 - stiffening, 305
- Cascode VA stage, 113
- CC (*see* Dominant-pole capacitor)
- CCS (*see* Constant current source)
- Center-tapped secondary, 316
- CF class B OPS (*see* Complementary-feedback class B OPS)
- Chopper designs (power supply), 52
- Class A amplifier output stage, 33,
 - 52–53, 143–145, 151–161
 - biasing methods, 154–157
 - high-performance design, 157–161, 350, 352, 353
 - push-pull design, 151–154
 - thermal overload in, 358
- Class AB amplifier output stage, 145–146
- Class B amplifier output stage, 33, 146,
 - 162–192
 - BJT output stages, 162–182
 - complementary-feedback design, 169–172

- Class B amplifier output stage (*Cont.*):
 - emitter-follower design, 163–168
 - MOSFET output stages, 182–192
 - paralleled output stages, 177–180
 - quasi-complementary design, 172–173
 - thermal overload in, 358
 - triples, output, 174–177
- Class C amplifier output stage, 146
- Class D amplifier output stage, 53, 54, 146–148
- Class E amplifier output stage, 148
- Class G amplifier output stage, 53, 54, 149
- Class H amplifier output stage, 53, 54, 149
- Class S amplifier output stage, 149–150
- Closed-loop gain, 219
- Collateral destruction, 185
- Commutation diodes, 149
- Compensation, 215
- Complementary-feedback (CF) class B OPS, 169–172
- Computerized analysis equipment, 391–392
- Computerized design/layout programs, 393–396
- Conductors, metal, 20
- Connection errors, 105
- Constant current source (CCS), 64–69, 151, 197–198
 - dual transistor, 66–68
 - JFET, 68–69
 - pseudo, 64–65
 - transistor-diode, 65–66
- Construction of high-power audio amplifiers, 313–327
 - application-dependent variables, determining, 324–327
 - basic topology, layout of, 319–324
 - cookbook designs, 329–355
 - basic MOSFET design, 330–332
 - class A design, 350, 352, 353
 - general-purpose designs, 347–349
 - high-power professional MOSFET design, 344–347
 - L-MOSFET designs, 338–347
 - Construction of high-power audio amplifiers, cookbook designs (*Cont.*):
 - low-distortion emitter-follower design, 350, 351
 - mirror-image L-MOSFET source-follower design, 341, 343–344
 - 1980s vintage design, 332–336
 - optimum low-distortion medium-power design, 336–338
 - optimum power design, 352, 354, 355
 - cost considerations in, 9–10
 - goal, establishing a, 314
 - mechanical layout, 378–382
 - obtaining parts/materials for, 10–12
 - power supply, designing, 314–319
 - printed circuit boards, 374–378
 - realistic expectations in, 7–9
 - and thermal dynamics, 357–374
 - delays, thermal, 372–374
 - heatsink evaluation, 362–364
 - OPS evaluation, 364–370
 - overload protection, 370–371
 - resistance, thermal, 358–361
 - wiring methods, 382–383
- Cost considerations, 9–10, 52
- Cross-conduction, 167, 232
- Crossover distortion, 24, 144, 179, 224–228
- Crosstalk, 19, 310–311
- Crowbar circuits, 276–278
- Current limiting circuit, 122
- Current mirror techniques, 69–73
 - advantages of, 69–70, 72–73
 - and differential balance, 71–72
 - example of, 70–71
- Current starving, 19
- Damping factor (DF), 46–48
- Darlington VA stage, 113–114, 120–121, 123–124
- DC input coupling, 44
- DC offset, 95
- Design:
 - computerized, 393–396
 - modification vs., 9
 - and predictability, 15–16

- DF (*see* Damping factor)
- Diagnostics (*see* Testing and trouble-shooting)
- Differential amplifier physics, 71
- Differential imbalance distortion, 232
- Differential VA stage, 114
- Distortion, 2, 5, 45–46, 224–234
 - beta-droop, 24, 228–231
 - capacitor, 233–234
 - crossover, 24, 144, 179, 224–228
 - differential imbalance, 232
 - fuse, 234
 - high-power, 233
 - phase, 54–55
 - second-order, 24
 - slew-induced, 43
 - switching, 167, 231–232
 - third-order, 24
 - VA loading, 232–233
- See also* Total harmonic distortion
- Dominant pole frequency (P1), 75–76, 84–85, 87
- Dominant-pole capacitor (CC), 110, 114–122, 215
- Domino effect, 58
- Dual transistor constant current source, 66–68
- Dual-polarity unregulated raw DC power supplies, 290–291
- Dummy loads, 209
- Dynamic bias, 143

- Early effect, 247
- EF class B OPS (*see* Emitter-follower class B OPS)
- Efficiency, power, 52–54
- Electrical safety, 37–38, 385–386
- Electronic overload protection, 245, 247–274
 - BJTs, 247–252, 267–270
 - MOSFETs, 264–267
 - multislope protection methods, 257–262
 - radical protection methods, 262–263
 - single-/dual-slope protection methods, 253–257
- EMI radiation, 291, 300–302

- Emitter-follower (EF) class B OPS, 163–168
- Encapsulated hybrid amplifier modules, 56–57
- Evaluation testing, 396–399
- External source resistance, 39

- Fall time, 235
- Feedback, negative, 60–62
- FETs, 91, 127
- Flat-pack devices, 160
- Forced-air convection, 362
- Frequency response, 24, 42–45
- Functional testing, 399–403
- Fuse distortion, 234
- Fuses, power supply, 303–304

- Global negative feedback:
 - and amplifier stability, 219, 220, 222, 223
 - application of, 62, 73
 - and input stage design, 79, 80, 88–89, 95
 - and output stage, 169
 - and three-stage model, 75–77
 - and VA stage, 110, 111, 114, 120, 124
- gm doubling, 145–146

- Harmonic content, 24
- Harmonic distortion (*see* Distortion)
- Hearing damage, 38
- Heathkit Company, 51, 294
- Heatsink evaluation, 362–364
- Heatsink grease, 360
- High quality (term), 4–6
- High-frequency region, 75
- High-frequency response, 44
- High-power (term), 4
- High-quality ground (HQG), 233, 382–383
- Hiss, 49
- HQG (*see* High-quality ground)
- Hum, 49
- Hum strap, 301
- Hybrid amplifier modules, 56–57
- Hybrid OPS, 190
- Hysteresis temperature, 363

- ICs (integrated circuits), 7
- Idling, 166
- IGBT (*see* Insulated gate bipolar transistor)
- Inclusive compensation, 217, 344
- Income opportunities, 12–13
- In-phase conditions, 54
- Input coupling capacitor, 99
- Input impedance, 39–40, 77
- Input requirements, 38–40
- Input sensitivity, 38–39
- Input stage, 63–107
 - constant current sources in, 64–69
 - current mirrors in, 69–73
 - definition of, 63
 - designs, evaluation of, 79–98
 - functions of, 63
 - isolation of, 79
 - signal conditioning circuits in, 98–106
 - and three-stage model, 73–79
- Insulated gate bipolar transistor (IGBT), 192–193
- Integrated circuits (ICs), 7
- Isolated secondaries, 316

- JFETs, 68–69, 90–93, 125–127
- Johnson noise, 49

- Lag compensation, 217
- Lateral MOSFETs, 182–189
- Lin three-stage architecture, 55, 59–60
- Line level, 1, 2, 21
- Linear regulated power supplies, 291–293
- Load, 40–42, 209
- Local negative feedback, 61, 76–77, 110, 111, 169
- Long-term component failure, 57
- Low-frequency region, 75
- Low-frequency response, 44–45

- Marketing considerations, 30–34
- Matched output pairs, 387
- Materials, obtaining, 10–12
- McComb, Gordon, 386
- Mean time between failure (MTBF), 55, 56

- Metal conductors, 20
- Miller capacitance, 75, 77–78, 109
- Miller dominant-pole compensation, 75
- Mirror-image topology, 92, 94–95
- Modification, design vs., 9
- Monoblock vacuum tubes, 19
- MOSFET amplifier(s), 8, 53, 91, 113, 115, 133, 134
 - basic design, 330–332
 - basic topology, 319–324
 - high-power professional, 344–347
 - low-distortion, 338–343
 - mirror-image, 341, 343–344
 - output stages, 182–192
 - BJT output vs., 183–187
 - configurations, 187–192
 - protection methods, 264–267
 - thermal overload in, 358
- MTBF (*see* Mean time between failure)
- Multislope V-I limiters, 258
- Music systems, 6–7
- Muting control, 280

- National Physical Laboratory, 43
- Negative feedback (NFB), 20, 21, 60–62, 73, 75–77. (*See also* Global negative feedback)
- Negative slewing, 235
- Nested feedback, 62
- NFB (*see* Negative feedback)
- Noise, 25, 31, 48–50, 91
- npn* transistors, 172–173
- Nyquist oscillation, 75
- Nyquist stability, 75, 209, 215, 350

- Ohm's law, 306
- Open-loop gain, 218–219
- Open-loop gain bandwidth, 119, 120
- OPS (*see* Output stage)
- Out-of-phase conditions, 54
- Output, power, 50–54
- Output capacitance, 205
- Output power ratings, 25
- Output stage (OPS), 52, 60, 73, 77, 80, 141–193
 - BJT output stages, 162–182
 - complementary-feedback design, 169–172

- Output stage, BJT output stages (*Cont.*):
 - emitter-follower design, 163–168
 - MOSFET output vs., 183–187
 - paralleled output stages, 177–180
 - quasi-complementary design, 172–173
 - triples, output, 174–177
- class A, 143–145, 151–161
 - biasing methods, 154–157
 - high-performance design, 157–161
 - push-pull design, 151–154
- class AB, 145–146
- class B, 146, 162–192
 - complementary-feedback design, 169–172
 - emitter-follower design, 163–168
 - MOSFET output stages, 182–192
 - paralleled output stages, 177–180
 - quasi-complementary design, 172–173
 - triples, output, 174–177
- class C, 146
- class D, 146–148
- class E, 148
- class G, 149
- class H, 149
- class S, 149–150
- IGBT output stages, 192–193
- MOSFET output stages, 182–192
 - BJT output vs., 183–187
 - configurations, 187–192
- purpose/function of, 142
- stability of, 201–214
 - external stability, 208–214
 - internal stability, 201–208
- Overall efficiency, 52
- Overdriving, 26
- Overload protection:
 - electronic. (*see* Electronic overload protection)
 - thermal, 370–371
- P1 (*see* Dominant pole frequency)
- Paging systems, 6–7
- Parts, obtaining, 10–12
- PFC (*see* Power factor correction)
- Phase distortion, 54–55
- Phase margin, 217
- Pole splitting, 78
- Positive slewing, 235
- Power, 4
- Power efficiency, 52–54
- Power factor correction (PFC), 52, 296, 297
- Power output, 50–54
- Power supplies, 289–311
 - bleeder resistors in, 306
 - calculations for, 306–307
 - choosing, 297–298
 - and crosstalk, 310–311
 - design of, 314–319
 - development of, 289–290
 - dual-polarity unregulated raw DC, 290–291
 - fuses in, 303–304
 - linear regulated, 291–293
 - and PSRR, 307–308
 - rectifiers, 302–303
 - reservoir capacitors in, 305–306
 - single-ended, 290
 - switch-mode, 291, 293–297
 - for testing, 388–391
 - transformers, 298–302
 - wiring techniques, 308–310
- Power supply droop, 300
- Power supply rejection ratio (PSRR), 60, 63, 73, 291, 307–308, 347
- Power supply unit (PSU), 52–53
- Preamp output, 1
- Preamplifiers, 1, 2
- Predictability of audio amplifier
 - design, 15–16
- Predictable reliability, 55
- Printed circuit boards, 374–378
 - construction of, 374–375
 - etching, 376–378
- Protection of amplifiers/loudspeakers, 243–287
 - with catching diodes, 286
 - electronic overload protection, 245, 247–274
 - BJTs, 247–252, 267–270
 - MOSFETs, 264–267
 - multislope protection methods, 257–262

- Protection of amplifiers/loudspeakers, electronic overload protection (*Cont.*):
 - radical protection methods, 262–263
 - single-/dual-slope protection methods, 253–257
- safety protection, 244–246
- speaker protection, 274–286
 - amplifier output fusing, 275–276
 - automatic protection, 278–286
 - crowbar circuits, 276–278
- Pseudo-constant current source, 64–65
- PSRR (*see* Power supply rejection ratio)
- PSU (*see* Power supply unit)
- Public address power amplifiers, 6
- Pulse width modulation (PWM), 147–148
- Push-pull operation, 146, 162–163
- Push-pull reaction, 95
- Push-pull VA stage, 115
- PWM (*see* Pulse width modulation)

- Qbias, 197–200, 372–374
- QC class B OPS (*see* Quasi-complementary class B OPS)
- Quality, 4–6
- Quasi-complementary (QC) class B OPS, 172–173

- Re prime, 198–199
- RE resistors, 177–180
- Recombination noise, 49, 91
- Recording studio monitor and mixdown amplifiers, 6
- Rectifiers, 291, 302–303
- Reliability, 55–58
- Reserve power, 51
- Reservoir capacitors, 289, 305–306
- Rise time, 235
- RMS, 314–315
- “The Robinson & Dadson Free-Field Equal-Loudness Contours,” 43

- Safe operating area (SOA), 248–250, 257
- Safe operating region (SOAR), 160

- Safety, electrical, 37–38, 385–386
- Safety protection, 244–246
- Sandman, Doctor A., 149
- Second breakdown region, 248
- Secondary breakdown, 247, 248
- Second-order harmonic distortion, 24
- Self, Douglas, 79
- Set-point temperature, 370
- Set-up procedures, 407–409
- Shunt compensation, 217
- SID (slew-induced distortion), 43
- Signal conditioning circuits, 1–2
- Signal virtual-earth, 73
- Signal-level voltages, 1
- Signal-to-noise ratio (SNR), 49
- Simulation engine, 393
- Single-ended power supplies, 290
- Slew limit, 235
- Slew rate, 25, 95–96
 - definition of, 234–235
 - equations for, 235–236
 - improving, 236–241
- Slew-induced distortion (SID), 43
- Sliding bias, 143
- Smart power supplies, 52
- SNR (signal-to-noise ratio), 49
- SOA (*see* Safe operating area)
- SOAR (safe operating region), 160
- Solid-state vs. vacuum tube controversy, 25–30
- Sound pressure level (SPL), 25, 42–43
- Sourcing-sinking action, 146
- Speaker cables, 33
- Specifications, high-power audio amplifier, 22–25
- SPL (*see* Sound pressure level)
- Stability, 195–224
 - bias generator, 196–201, 223
 - output stage, 201–214, 223
 - external stability, 208–214
 - internal stability, 201–208
 - of overall amplifier, 214–222
- Star point (star ground), 233
- Statistical reliability, 55, 57
- Stiffening capacitors, 305
- Still-air convection cooling, 362
- Stilpads, 360
- Subjectivism, 15–21, 34, 51

- Super Cricket, 387
- Surround-sound systems, 26–27
- Switching designs (power supply), 52
- Switching distortion, 167, 231–232
- Switch-mode power supplies, 291, 293–297
- Sziklai-pair (*see* Complementary-feedback class B OPS)

- Tail current, 64
- Test leg, 70
- Testing and troubleshooting, 385–411
 - equipment requirements, 386–396
 - capacitor-inductor analyzer, 388
 - computerized analysis equipment, 391–392
 - computerized design/layout programs, 393–396
 - DC power supplies, 388–391
 - matched output pairs, 387
 - variac, 387
 - evaluation testing, 396–399
 - functional testing, 399–403
 - load testing, 409–411
 - set-up procedures, 407–409
 - symptomatic troubleshooting:
 - commercially manufactured amplifiers, 404–407
 - personal projects, 403–404
- THD (*see* Total harmonic distortion)
- Thermal chimney effect, 362
- Thermal cycles, 55–56
- Thermal cyclic curves, 55
- Thermal delays, 200–201
- Thermal dynamics, 357–374
 - delays, thermal, 372–374
 - heatsink evaluation, 362–364
 - OPS evaluation, 364–370
 - overload protection, 370–371
 - resistance, thermal, 358–361
- Thermal resistance, 358–361
- Thermal runaway, 165
- Thermal stability/reliability, 142
- Thermal tracking, 165
- Thermostatic protection, 299–300
- Third-order harmonic distortion, 24
- Three-stage architecture, 59–60, 73–79

- TID (*see* Transient intermodulation distortion)
- Tone controls, 20
- Topologies, audio power amplifier, 58–60
- Total harmonic distortion (THD), 21–24, 45, 46, 57
- Transconductance amplifier, 60, 63, 79
- Transformers, 32, 298–302
- Transient intermodulation distortion (TID), 19–21
- Transimpedance amplifier, 60, 73
- Transistor-diode constant current source, 65–66
- Transparent amplification, 2, 26
- Trip temperature, 370
- Triples, output, 174–177
- Troubleshooting (*see* Testing and troubleshooting)
- Turn-on thumps, 280
- Two-pole compensation, 118–120, 171
- Two-stage design architecture, 58–59

- VA loading distortion, 232–233
- VA stage (*see* Voltage amplifier stage)
- Vacuum tube vs. solid-state controversy, 25–30
- Variable-frequency AC motor controls, 273
- Variac, 387
- V_{be} multiplier, 197
- V_{be} multiplier bias circuit, 358
- V_{bias}, 151, 155, 165–166, 169, 196, 199
- Voltage amplifier (VA) stage, 22–23, 60, 77, 80, 109–140
 - bootstrapped, 114
 - buffered, 114–115
 - cascode, 113
 - common misconceptions about, 110–111
 - with current source load, 111, 113
 - Darlington, 113–114
 - differential, 114
 - dominant-pole capacitor,
 - determining value of, 116–118
 - modern topologies for, 124–140
 - differential VA stage with JFET input stage, 125–127

- Voltage amplifier (VA) stage,
 - modern topologies for (*Cont.*):
 - high-performance input and VA stage design, 127–131
 - mirror-image input stage feeding complementary VA with active loading, 131–136
 - ultrahigh performance input and VA stage combination, 136–140
 - optimization of, 120–124
 - purpose/function of, 109–110
- Voltage amplifier (VA) stage (*Cont.*):
 - push-pull, 115
 - with two-pole compensation, 115–116, 118–120
 - typical topologies for, 111–116
- Wind tunnels, 362
- Wiring techniques, 308–310, 382–383
- Z meters, 388
- Zobel network, 209–214

ABOUT THE AUTHOR

G. Randy Slone is an electronics engineer, a consultant, and author of four books, including *The TAB Guide to Understanding Electricity and Electronics*. His consulting clients have included DuPont, Champion International, and Ralston Purina. A former college instructor, Slone also operates Seal Electronics, a mail order business. He spends much of his time working in his state-of-the-art home electronics laboratory.

This page intentionally left blank.

This page intentionally left blank.

This page intentionally left blank.